

# TALES OF RED

## STREET STORIES



9 MISSIONS FULL OF ACTION AND INTRIGUE FOR **CYBERPUNK**  
R E D



# TALES OF THE RED

## CAST AND CREW

**Writing and Design by** Fran Stewart, Jay Parker, Melissa Wong, Mike Pondsmith, Monica Valentinelli, and Trace Wilson

**Additional Development by** Aron Tarbuck, Cody Pondsmith, J Gray, and James Hutt

**Project Management by** Aron Tarbuck and Mike Pondsmith

**Editing by** Linda Evans, Matt Click, and Michael Matheson

**Business Management by** Lisa Pondsmith

**Art Direction by** Jaye Kovach

**Cover Illustration by** Bad Moon Art Studio

**Interior Illustration and Graphics by** Adrian Marc, AgusSW, Bad Moon Art Studio, Catatau, Dani Hartel, Diego Martinez, Domhnall Hegarty, Eddie Mendoza, Ernanda Souza, Hélio Frazão, Jeffrey McDonald, Neil Branquinho, Pedram Mohammadi, Richard Bagnall, Santiago Betancur, Sebastian Szmyd, Shen Fei, Storn A. Cook, and Torben Weit

**Cartography by** Alex The Mapmaker, Borja Alonso, Derek Ruiz (Elven Tower), J Gray, Jon Abbiss (Paper Griffin), Matt Henderson, MikaelMaps, Niels E. Wisth, Saga Mackenzie, and Zovya RPG

**Layout and Page Design by** J Gray

**Playtesting and Beta Reading by** Adam Duffy, Alessandra Guccione, Alexis.D, Andy Wiersum, Bram Louvenberg, Célestin Vieu, Chris "Case" Needy, Clayton Condit, Collin "Crosswire" Clohessy, David "Dryss" Berland, David Kilgannon, David Mager, Elephant Seal, Florian G., Iceo (M.K) Berg, jenncgf, Jimmie D. Carter, Kaidyn Kravetz, Karim Edouard, Kirill Zelenko, Les MCD, LuiLu92, Luis Salsa, Luke "Big Baz" Gaffney, Marco Palmieri, Mark Milner, Mathieu Maas, Mike St. John, Mitch Moren, Mr. Pillage Idiot, Nes, Nick Clohessy, Noah Smith, Olivier Larue, Rafael Alberto III, Raven Stone, Ryan "Boss\_Angler" St. John, Ryan "Rysk" Skogstad, Sasho Coates, Sean "Rye Ansdad" Page, Shawn Gregory, Sion "Lugosi" Morgan, Tavner "God" Phillips, and Will Sandy

**Special Thanks to** Patrick Mills



CR3051 • ISBN 978-1-950911-27-1 • First Printing • Digital v1.2 • Printed in the United States

Copyright © 2022 by R. Talsorian Games, Inc., Cyberpunk is a registered trademark of CD Projekt Red S.A. All rights reserved under the Universal Copyrights Convention. All situations, governments, and people herein are fictional. Any similarities portrayed herein without satiric intent are strictly coincidental.





## WELCOME, GAMEMASTER, TO TALES OF THE RED!

We've gathered a group of amazing and talented writers to craft nine Tales to experience in **Cyberpunk RED**. To enjoy them, you'll need the **Cyberpunk RED** Core Book, some six and ten sided dice, and a crew of layers to run them with. These nine Tales will take your players all over Night City. Here's what's inside.

In **Night at the Opera**, they'll be in the University District, investigating a string of kidnappings on the behalf of the underfunded and over-burdened NCPD, at the bequest of a wealthy Exec. But how are the Philharmonic Vampyres involved? You'll have to get on campus to find out.

**Agents of Desire** is a seemingly simple job that twists wildly out of control. When the line between Agent and Human is blurred, how will your Crew react?

In **A Bucket Full of Popcorn-Flavored Kibble**, they'll will be jockeying for a piece of the silver screen - as an extra on the Senait Sisters' upcoming historical romance, *The Parisian Hostess*. Is your Crew ready for the spotlight?

**Drummer and the Whale** takes your Crew under the waves to track down the source of a strange signal, theorized to be pre-war tech. Then, things go really, really wrong. How is your Crew gonna react?

**Haven't Got a Stitch to Wear** is a classic street-level story. When the courier system that Night City businesses rely upon is disrupted, it's up to your Crew to get things moving again.

**Reaping the Reaper** pits your Crew against a deadly AI threat. It's a messy one, perfect for Edgerunners looking for a good fight.

**Staying Vigilant** has your Crew chasing down a rumored cyberpsycho terrorizing The Street. Numerous crews have been buried already. Is your's next?

**Bathed in Red** is part one of a two-parter that closes out the book. It all starts in a Little Europe virtuality club called Delirium, and it quickly gets wild as a Netrunner named Red Knight starts causing chaos.

**One Red Night** is part two of the tale that began in **Bathed in Red**. After everything they've been through, your Crew will get their chance to take Red Knight off the board, permanently.

Where to start? I recommend you start at the very beginning with **Night at The Opera**, and make your way through the book from front to back. We've placed each Tale in the order we'd run them in during a campaign, but you know what your Crew needs. You're the Gamemaster after all. Good luck in there. We're rooting for you!

### HAVE FUN IN NIGHT CITY!

JAMES HUTT

GAME DESIGNER AND MAYOR OF BALANCE TOWN

The Missions in this book use the Beat Chart system (**SEE CP:R PAGE 395**) to pace and focus story flow. Each Mission breaks down into **Background** (read aloud text designed to set the mood), **The Rest of the Story** (a summary of the Mission for the GM), **The Setting** (a summary of important locations in the Mission), **The Opposition** (a summary of potential enemies), and **The Hook** (a guide to getting the Crew into the Mission) all followed by a series of **Developments** (non-action Beats, labeled as **Dev** in the header) and **Cliffhangers** (action Beats, labeled as **Cliff** in the header). They eventually lead to **Climaxes** (the big finale) and **Resolutions** (the wrap-up).

**GMs, read each Mission carefully.** The flow of Beats isn't always linear. Some Missions have branching paths where specific Beats only occur if the Crew takes certain actions. There might even be multiple possible Climaxes and Endings! In addition, some Missions contain Optional Developments (OpDev) and Cliffhangers (OpCliff) to be thrown in at your discretion.

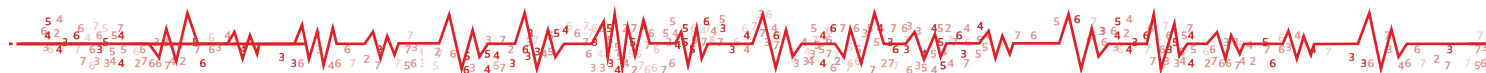

BY NEIL BRANQUINHO



# A NIGHT AT THE OPERA

## *DARKNESS AND DESIRE IN NIGHT CITY*

<b>Background</b> .....	<b>6</b>	<b>Dev (Noodles and Info)</b> .....	<b>10</b>
<b>The Rest of the Story</b> .....	<b>6</b>	<b>OpDev (Empty Office Hours)</b> .....	<b>11</b>
<b>The Setting</b> .....	<b>6</b>	<b>Cliff (Darkness and Light)</b> .....	<b>11</b>
<b>The Opposition</b> .....	<b>6</b>	<b>Climax (Monster Hunt)</b> .....	<b>12</b>
<b>The Hook</b> .....	<b>6</b>	<b>Resolution (Epilogue)</b> .....	<b>14</b>
<b>Dev (Getting Tickets)</b> .....	<b>7</b>	<b>NET Architectures</b> .....	<b>14</b>
<b>Cliff (Night at the Opera)</b> .....	<b>7</b>	<b>NPC Stat Blocks</b> .....	<b>15</b>

# A NIGHT AT THE OPERA

## BACKGROUND (READ ALOUD)

### Net 54 Crimewatchers: String of Missing Persons Claims Rocklin Augmentics Daughter

NCPD has reported that Lucy Rhinemeyer, 19-year-old daughter of Rocklin Augmentics Executive Engineer George Edward Rhinemeyer, has joined the growing number of missing young women in Night City. Over the last four weeks, seven women have been reported missing across the University District. Their whereabouts are a complete mystery to NCPD detectives, who still have no leads. Mr. Rhinemeyer has yet to be reached for comment.

Early in the morning, you receive a message from Mr. Rhinemeyer's representative:

"As you may know, my client's daughter went missing in the University District. We have had little cooperation from the local authorities. My client has authorized me to pay out 2,000eb per head to contractors of my choice. You come highly recommended. You will each receive 500eb upon the signing of a contract with Rocklin Augmentics, with the remainder of the funds issued once Lucy Rhinemeyer has been recovered—in whatever state you happen to find her. Good hunting."

## THE REST OF THE STORY

The kidnapper is Lord Ruthven, an ex-Philharmonic Vampyres member who has gone cyberpsycho. He has convinced himself he is a true vampire and deserves the ultimate vampire bride: Barbara Dahl, the nightly news anchor of Network 54 in Night City.

Unable to kill him without outside aid, the leader of the Philharmonic Vampyres has concocted a plan to pose as an intermediary to the latest victim's father in order to hire the Crew without alerting either the NCPD or the general public to their connection to the killer.

## THE SETTING

This story takes place mainly in the University District in Night City, and takes the Crew from a gothic opera house to a showdown with a cyberpsycho in an abandoned church at the border of the Combat Zone.

## THE OPPOSITION

- **The Monk and the Clown.** Two former gangers who now serve as Lieutenants for Lord Ruthven.
- A horde of **Bozo and Inquisitor Mooks** who left their gangs to follow the Monk and the Clown in service to Lord Ruthven.
- **Lord Ruthven**, a lone cyberpsycho and dangerous killer who has become convinced he is a true vampire.
- Members of the **Philharmonic Vampyres** gang (should the Crew seek violence with them).

SEE PAGE 15 FOR STAT BLOCKS

## THE HOOK

In a span of four weeks, seven women have vanished from the University District. Campus Security and NCPD are trying to investigate, but are overwhelmed dealing with spikes in gang activity in the University District and South Night City border. NCPD was struggling to keep up with the investigation, but that's all changed now: Mr. Rhinemeyer started bankrolling the NCPD's investigation a week ago, bribing them to change their policing priorities for the sake of his daughter. This is also where the Crew comes in. Through the cooperation of NCPD and their new patron, they've been offered a job.

Or, at least, so it seems. In truth, the Edgerunners are pawns in an over dramatic scheme by The Master, a Philharmonic Vampyre leader, to deal with the problem discretely.

Contacts at Campus Security don't have much for leads, but suspect the Philharmonic Vampyres, due to the disappearances happening on their turf and fitting their behavior.

The cops can't walk into a Philharmonic Vampyres' gathering without causing major problems (and they are also quick to mention that's outside their authority), so the Crew's patron has tasked them with gaining access to one of the Vampyres' parties and investigating.

GO TO DEV (GETTING TICKETS)

# A NIGHT AT THE OPERA

## DEV (GETTING TICKETS)

The Edgerunners notice an ostentatious poster plastered over a nearby bus stop. It reads *Come to a Night at the Opera with the Philharmonic Vampyres* and on the poster are a collection of shadows striking classic vampire cinema poses.

The date is for tomorrow night. At the bottom of the poster is a link to Garden Patch, from which you can buy tickets. It also includes a note about the event's dress code, which is listed as *Old World meets New World: Drama, Sensuality, Black Velvet, Danger*.

The location of the show is the old Night City Symphony Hall, just off campus in the University District. The Philharmonic Vampyres have been busy promoting around the district. The show is gaining steam, and university students have been buying up tickets. Even if the show were to flop, the students would likely turn it into a rave.

There are six students crowding the area, waiting for the bus. They are all talking about the party, and answer questions if asked. Here's a sampling of what they have to say.

- *"The Philharmonic Vampyres are such a joke. The only reason people like them is because the audience usually ends up naked—hell, half the time it's just a glorified orgy. And these kidnappings are serious. Seven women missing is nothing to dismiss. NCPD needs to do something. Campus security is useless."*
- *"What do you want? I'm sorry, I don't talk to street people. Kidnappings? Terrible business. I've got enough to deal with—like my stupid psychology thesis advisor not answering his damn mail." If the Crew follow up on this **GO TO OPDEV (EMPTY OFFICE HOURS)**.*
- *"This is going to be **the** event of the week. Those vamp shows are always so stylish. Missing women? Don't be such a downer."*
- *"I like cute theater guys. That's why I'm going. And it's not like everyone gets laid. It's a party, people hook up. Big deal. Kidnappings? Really? I mean, people shouldn't be walking alone at night."*

- *"Those vamps are artists, man. Kidnappings? You'd think that the vamps would be pulling a stunt like that. Nah, word on the street is Vamps are just as concerned about the missing women. Heard a pair of vamps talking about it. Pretty hush, hush stuff there."*
- *"The vamp show? What would I want to see those neck-sucking freaks for? Not my scene. All the weirdos will be there for sure. I'll be working out instead. Check out these biceps. Mm-hmm—premium A1 Freshpak **beef** right here. Kidnappings? If I knew anything, I'd be the one kicking serious chrome, but no. And that shit isn't cool, man. The babes are not as willing to go out on dates. I haven't gotten any output in a week."*

## GO TO CLIFF (NIGHT AT THE OPERA)

## CLIFF (NIGHT AT THE OPERA)

Just after sundown on the night of the party, a line forms outside the symphony hall. A Campus Security aerodyne that's seen better days sits parked outside, and a pair of Campus Security officers direct the crowd. A DV 9 Perception Skill Check reveals that both officers have Vampyres (**SEE CP:R PAGE 363**) installed.

The hall itself features four large pillars atop a large set of old marble steps. The stonework is worn and neglected. Between the two center pillars stands a massive door that hangs wide open. A man in a black suit and a black top hat stands in the doorway. A red cloak rests on his shoulders and drapes down his back. In his right hand he holds a black cane with a silver bat head handle. His face is ghost white, matching his fancy gloves.

*"Come one, come all! Come, come! Come see sights of amazement from an age long since lost in! You will see wonders that will astonish! Come, come all!"*

Behind the host, a handful of burlesque figures dance. The vamp at the main door reads ticket codes with their cybereyes. Nobody checks for weapons. The vamp ticket-taker tells the Crew to enjoy the show as they flash a pair of pearly white fangs.

The lobby is decorated with long red drapes and holograms featuring notable vampires of classic cinema. The doors leading to the auditorium have red

# A NIGHT AT THE OPERA

velvet padding and gold rivets. Twin burlesque dancers perform beside the doors, their skin ghost white. They croon: *“Please be seated, the show is about to begin.”* Inside the auditorium, plastic covers the seats.

A bellhop hands out white synthetic silk handkerchiefs as people sit. Fake trees adorn the stage, with large white tapestries hanging from both sides. Tchaikovsky’s *Swan Lake* serenades the audience as people find their seats.

The lights dim. The show begins. The production of *Dracula* mixes classic horror cinema with a futuristic motif. Half-naked performers sling buckets of fake blood at each other and the audience as classic theater meets modern performance art.

## FIGHT AT THE OPERA

Suddenly, from backstage, a voice cries out: *“You two can’t be back here,”* followed by gunshots. Chaos breaks out as people quickly realize the gunshots aren’t part of the show. People begin to stampede out of the venue.

The Crew is locked in by the crowd behind them and the firefight in front of them, and have no choice but to roll Initiative as the combat spills out onto the stage and the assailants reveal themselves: a Bozo (the Clown) with some serious optical cyberware (**SEE PAGE 15**), and an Inquisitor (the Monk) dressed in brown robes (**SEE PAGE 16**).

At the start of combat, a number of Vampyres (**SEE PAGE 15**) equal to the Crew draw their weapons and enter the fight. Initially, they target the Bozo and the Monk, but defend themselves against the Crew if attacked. During the first 3 Rounds, all Skill Checks suffer a  $-4$  modifier due to the screaming chaos of the opera house. Any Edgerunner with a Cyberaudio Suite is immune to this negative effect, as they can automatically tune out the horrible noise.

For the first 2 Rounds of the combat, the Bozo and the Monk divide their attacks evenly among the Edgerunners and the Philharmonic Vampyres. The Bozo and the Monk will attempt to escape if one of three things occur.

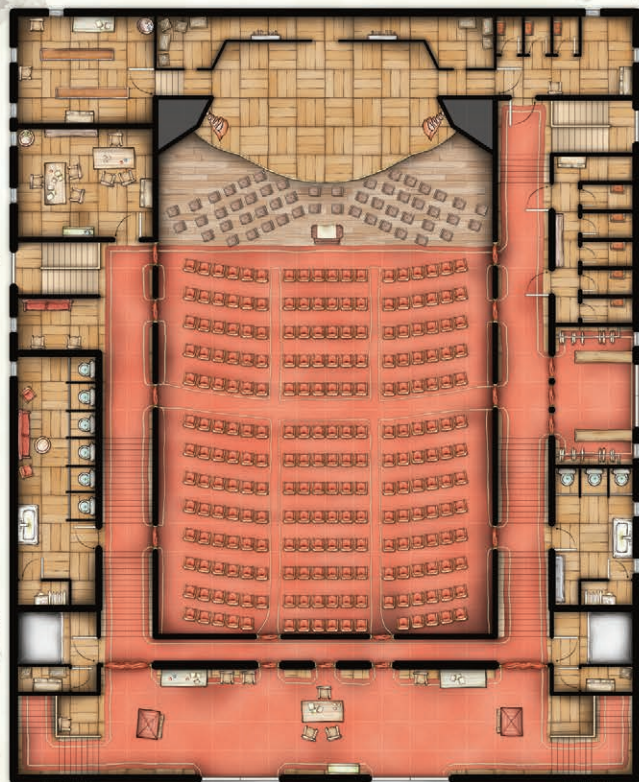

Symphony Hall Lower Floor

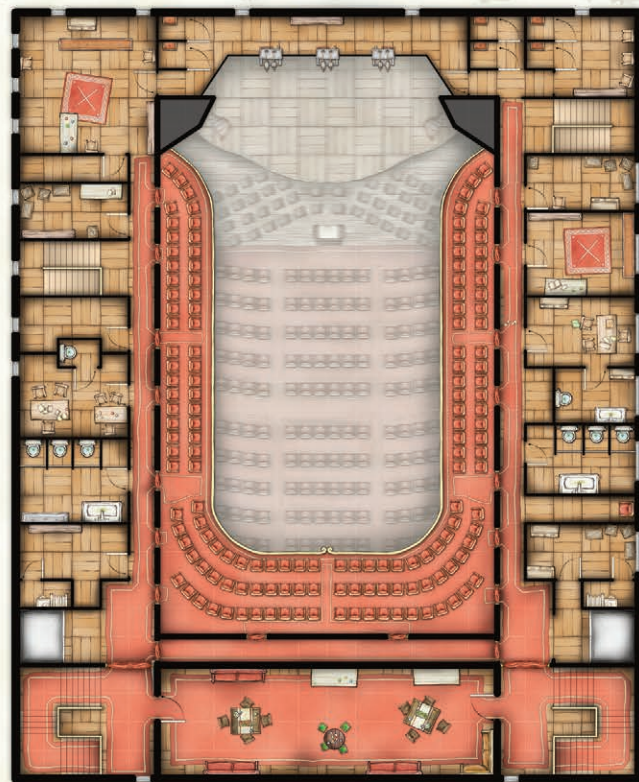

Symphony Hall Upper Floor

BY DEREK RUIZ (EVEN TOWER)



# A NIGHT AT THE OPERA

- Combat lasts more than 3 Rounds.
- Either one suffers a Critical Injury.
- Either reaches the Seriously Wounded Wound State.

When attempting to escape, they will use their full Turn and the Dash Action. Should either be unable to escape, they use their final desperate action to detonate a held Armor Piercing Grenade, camouflaged either as a rosary bead or a water balloon, killing themselves instantly.

As GM, don't step in to save either the Monk or the Clown if it would seem like a cheap or unearned escape. The Edgerunners will get another chance at them before the ending of the mission, though, so do try and get one to safety.

When the battle is over, the lights in the hall go dark. An Edgerunner with an ability to see or sense in low light/darkness will detect dozens of figures moving about, most grabbing the dead or wounded. Other well-armed figures wearing black cloaks take up strategic positions. Suddenly, dozens of red eyes appear in the dark.

The squeaking of bats and a flurry of wings precedes the arrival of a figure who steps out of a cloud of holographic smoke. He wears a fine black suit from an era long since passed. His black hair is parted to the right, identical in looks to horror legend Bela Lugosi.

*"My production of Dracula is in shambles. Some of my children are dead. I am beside myself with grief. Leave. All of you. I need time to think and bury my dead. I may summon you again, but now is not the time. There will be no retaliation. Leave now—before I change my mind."*

Outside the hall the streets are empty. No one stuck around to see how it all played out. Even the junky Campus Security aerodyne is gone. Apparently, they aren't being paid enough to risk their lives for an off-campus theatrical production.

The Crew has time to rest up and heal, if they need it. When they are ready, **GO TO DEV (NOODLES AND INFO)**.

BY NEIL BRANQUINHO



The Clown

BY DANI HARTEL



The Monk

# A NIGHT AT THE OPERA

## DEV (NOODLES AND INFO)

Several days have passed since the encounter at the Night City Symphony Hall. Everyone should have received medical attention and be back in working order. In the afternoon, the Crew receives another message from Mr. Rhinemeyer's representative.

*"Purchase an extra-large bowl of noodles with kibbleflakes at the indicated coordinates. Wear a green hat."*

The message flashes, updating the position of the goal every 15 seconds. Plugging them into an Agent reveals that the point in question is in the University District, on the Night City University Campus, outside the cafeteria.

When the Crew approaches the location, they find it swarmed with students, enjoying a break from the food offered by the university's cafeteria, sitting on the

synthetic grass surrounding the student plaza. Anyone wearing visible armorjacks or openly carrying a weapon here sticks out like a sore thumb, but Campus Security is nowhere to be seen.

Walking across the Night City University lawn, the Crew can overhear several student conversations.

- *"Oh my god, I knew someone that was at that party! I'm glad no students got hurt. I hear the after party was good. There were so many of us—I mean the students—that they overwhelmed security. I bet the Execs were freaked. Or maybe they were into it. I wouldn't know."*
- *"I hear none of the psychology majors can get their thesis papers accepted. They are totes starting to freak out. Guess they should have picked a hard science like us. A couple more months, then Biotechnica, here we come!"* If the Crew follows up on this, **GO TO OPDEV (EMPTY OFFICE HOURS)**.
- *"Doesn't this taste like pancakes? I'm not crazy, right dude? This meatball sub tastes like pancakes. I think they used the wrong kibble. Try it. It's kinda good though."*
- *"Ugh. That vapid Professor Huntver still hasn't gotten back to me about my thesis! I went to his office hours, but he wasn't there, and the door was totally, like, locked! What an asshole. How am I supposed to defend in a week if I can't get my advisor to answer even the most basic messages. I think he's on drugs or something."* If the Crew follows up on this, **GO TO OPDEV (EMPTY OFFICE HOURS)**.
- *"Guess who just got into the summer internship program at Zhirafa? Yeah, I just got the mail today. Luckily, after the midterm. Who wants to get drunk tonight?"*

The location of the coordinates is a popular noodle truck in the center of campus. Ordering the correct order with or without wearing the green hat is the signal for a number of Philharmonic Vampyres in the crowd of students equal to twice the number of players to approach the party while wiggling their heads suggestively. It's also possible to spot them in the crowd beforehand with a DV 13 Perception Skill Check.

Once they approach, the Vampyres are easy to identify by subtle fashion choices, fangs, and near universal application of heavy eyeshadow. One Vampyre



BY NEIL BRANQUINHO

# A NIGHT AT THE OPERA

introduces themselves as Renfield and offers the Crew an envelope with an invitation to meet “The Master” at the stroke of midnight in the opera house. After he delivers the message, Renfield bows again before the Vampyres all disperse and blend back in with the crowd. The Vampyres are not looking for a fight, and will flee if engaged in combat, leaving only the note, using Smoke Grenades to make their escape.

## GO TO CLIFF (DARKNESS AND LIGHT)

### OFFICE (EMPTY OFFICE HOURS)

The fourth floor of the social sciences building overlooks the campus and the nearby main strip of the University District. Professor Huntver’s office is at the end of a hallway. On it, psychology majors have taped several notes eager to talk about their theses, written in varying degrees of desperation. The door is locked, but a DV 9 Pick Lock Skill Check easily opens it. Busting it open is a DV 13 Athletics Skill Check, which succeeds automatically if an Edgerunner has a Melee Weapon on hand.

If they choose to investigate, they can discover the following suspicious things.

- With a DV 9 Perception Check while searching the desk: A framed picture of Barbara Dahl, anchor of the evening news in Night City for Network 5, sits on the desk. A kiss marks the photo in faded red lipstick.
- With a DV 13 Perception Check while investigating the closet: A clown costume hangs in the back of the wardrobe, along with an Inquisitor uniform, both stained in blood. These are hidden behind a set of academic regalia.
- With a DV 13 Perception Check while searching the desk: A lock secures a mini fridge underneath the desk. Breaking it open requires a DV 13 Athletics Skill Check, which succeeds automatically if an Edgerunner has a Melee Weapon on hand. A DV 9 Pick Lock Skill Check also pops it open. Inside is a bottle of genuine vodka (worth 500eb), a squat bottle of bloody mary mix, a jar of real pickled asparagus, a frosted glass, **and a preserved human head.**

A DV 13 Criminology, Library Search, or Streetwise Skill Check reveals the severed head belongs to the late Kenneth Dahl, Barbara Dahl’s late husband. If the Crew

seeks to return the head to Barbara Dahl, she accepts it graciously through an intermediary, mentioning that his grave was robbed months ago, and she has been dealing with it privately. If the Crew agrees to keep this under wraps, she owes them a small favor. Strangely, if asked, she doesn’t know anyone named Huntver, but she does offer that she’s been stalked several times before. For her, it comes with the territory.

## GO TO CLIFF (DARKNESS AND LIGHT) OR CLIMAX (MONSTER HUNT) AS APPROPRIATE

### CLIFF (DARKNESS AND LIGHT)

The Crew returns to the Night City Symphony Hall to meet with the Philharmonic Vampyres. The area is pretty busy, with university students heading back to their apartments and dorms. There are no outward signs of what transpired a couple nights ago. At the top of the marble steps stands one of the vamps, dressed in the typical fancy black suits with that classic Hollywood vampire motif. When he sees the characters, he smiles, his fangs glistening in the illumination from street lamps.

*“The Master has been awaiting you. Come.”* The vamp motions for the characters to follow.

The vamps show no signs of aggression. They offer the characters refreshments—cherry red drinks and tasteless cookies—when they enter the lobby. The burlesque dancers wave and blow kisses. The characters are led down a hallway which ends at a pair of synthetic wooden doors with what is probably the seal of Vlad Tepes in gold on it. The vamp knocks on the door three times and it opens majestically. Inside there is a large room illuminated by black candles. Red carpets cover the floors and red tapestries hang from the walls. There are two large chairs at the opposite end of the room and a fake fireplace with a holographic fire flickering. A man and a woman stand in front of the fire, holding hands. The man turns, a perfect replica of Bela Lugosi. The woman leaves swiftly, carefully checking a box on an oversized clipboard. The Master speaks.

*“We have a mutual problem that must be dealt with. By now you may have probably deduced that this problem was once one of us. Lord Ruthven arrived here just after Night City was bathed in fire and offered to fund the Philharmonic Vampyres’ rebirth. He was a visionary and an artist. Plus, he had... considerable*

# A NIGHT AT THE OPERA



BY RICHARD BAGNALL

monetary resources. But he had a dark side and many secrets that he wouldn't share with us. What we do pays homage to the past. We may partake in archaic rituals and drink the occasional glass of blood, but we are not monsters—not murderers. We are romantics. There is no art left in Lord Ruthven. Now, he is only a monster. Truly. He began taking it too far and when we confronted him, he threatened to kill us all ... and he is more than capable. You see, he's gone cyberspycho."

The Master rubs his forehead, evidently beside himself at the pronouncement. Or perhaps just committing to his role. It's hard to tell.

"Ruthven is beyond our control. That's why we've summoned you here. We will allow you to kill him without retribution. While we cannot be seen to be aiding NCPD, we have discovered where this monster's lair is. Take it. Along with this wooden stake, make haste to the Union Chapel Building, and make sure the task is done right. Do so, and you will earn our favor. I will also make sure you are paid through your intermediary with the venerable Mr. Rhinemeyer. Good hunting, Edgerunners."

**GO TO CLIMAX (MONSTER HUNT)**

## CLIMAX (MONSTER HUNT)

The Master's data puts Lord Ruthven's base of operations just across the border in South Night City. The silence here is eerie. The front door to the Union Chapel stands wide open. A neon "Open" sign flickers every few seconds. Looking at the entrance carefully, it's almost like a large mouth awaiting a meal to just walk right in. All other access points to the Union Chapel are blocked by rubble.

The outside is well guarded, too. If the Monk or the Clown survived, they guard the door, alongside a number of mooks (**SEE PAGES 16 & 17**) equal to the number of Edgerunners minus 2. If only the Monk survives, all of the mooks are Inquisitor Mooks. If instead only the Clown survived, all of the mooks are Bozo Mooks. If both the Monk and the Clown survived, the Mooks are split in allegiance 50/50. If neither survived, skip this encounter, and the Union Chapel Building is seemingly undefended.

In this combat, all adversaries fight to the death. They are too terrified of the torture that awaits cowardice by the hands of Lord Ruthven to do anything else, and



# A NIGHT AT THE OPERA

As the Edgerunners move to the altar, two figures jerk to life and stand up. They quickly spin around. The two robed figures are automated turrets armed with Assault Rifles (SEE PAGE 174). They can't move from their spot, but pivot and track Edgerunners. The sentries don't stop shooting until stopped or the characters are dead. Each is controlled by its own NET Architecture.

Once the turrets are dealt with, immediately, the characters are interrupted by a towering figure who steps out from behind the tapestry. He wears a black medical uniform and a flowing black hooded cloak. His face is gnarled by large metallic fangs which have stabbed jagged curves into the corners of his mouth. Lord Ruthven (SEE PAGE 17) quickly attacks.

*"Witness my supremacy, vermin!"*

The battle with Lord Ruthven is to the death. Once he is killed, the Crew can look behind the tapestry where they find a sterile white hallway illuminated by the glow of soft white LED lights. There is an oversized medical pod with six naked women crammed inside, each biosculpted to look like Barbara Dahl, Network 54 anchor woman, to varying levels of accuracy. Whatever twisted reasoning was behind this died with Ruthven. Only one is alive, barely conscious, and slicked wet with cryo fluid from a smashed pod, clothed in a shawl and paralyzed with fear. The others have long since been lobotomized. The lone survivor is Lucy Rhinemeyer, underneath the bodysculpting. After confirming this, she faints at the feet of her rescuers.

## GO TO RESOLUTION (EPILOGUE)

### RESOLUTION (EPILOGUE)

Lucy Rhinemeyer, after therapy, will be able to lead a fulfilling life once again. The bodies of the other six women are returned to their families, and for their funeral services, Lucy and her father arrange for Rocklin Augmentics to pay for postmortem biosculpting so they can be laid to rest with their original faces. The Crew are paid the remainder of their wages, and if they remembered to stake Lord Ruthven through the heart, or have done something equally dramatic, such as decapitating him, they have earned a favor with the Philharmonic Vampyres.

*As our tale meets its bloody end, the curtain falls on tonight's entertainment. Sleep tight, Night City. Lock your doors, bar the windows, and turn out the lights, and maybe, just maybe, the monsters will pick another house tonight.*

## NET ARCHITECTURES

### ► UNION CHAPEL TURRET CONTROL #1

Demons Installed: None

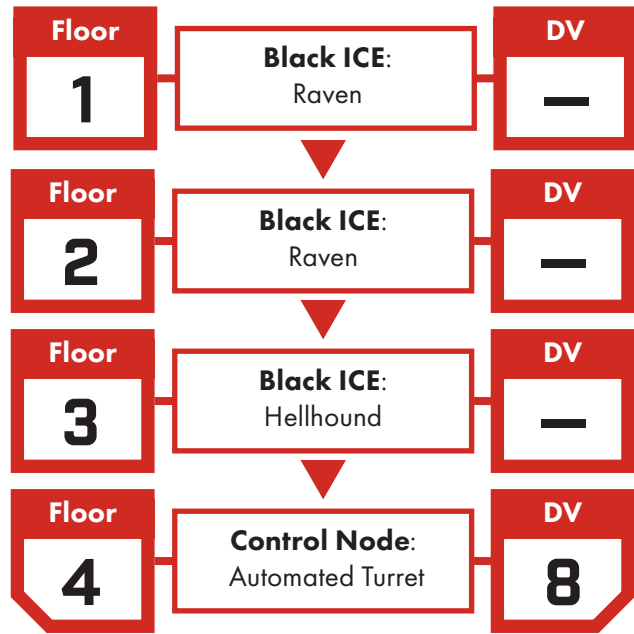

### ► UNION CHAPEL TURRET CONTROL #2

Demons Installed: None

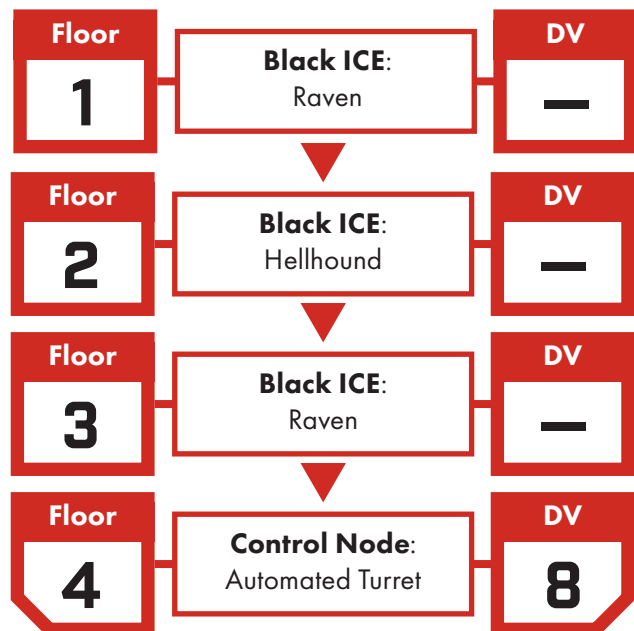

# A NIGHT AT THE OPERA

## NPC STAT BLOCKS

For more information on important NPCs **SEE APPENDIX B: BIOGRAPHIES.**

<b>NAME</b>	<b>PHILHARMONIC VAMPYRE MOOK</b> (REP 0)			<b>SERIOUSLY WOUNDED</b>	<b>15</b>	<b>HP</b>	<b>30</b>										
<b>ROLE</b>	<b>NONE</b>			<b>DEATH SAVE</b>	<b>2</b>												
<b>STATS</b>																	
<b>INT</b>	<b>6</b>	<b>REF</b>	<b>6</b>	<b>DEX</b>	<b>5</b>	<b>TECH</b>	<b>4</b>	<b>COOL</b>	<b>6</b>	<b>WILL</b>	<b>6</b>	<b>MOVE</b>	<b>7</b>	<b>BODY</b>	<b>2</b>	<b>EMP</b>	<b>7</b>
<b>WEAPONS</b>								<b>ARMOR</b>									
<b>VAMPYRES</b>				<b>ROF2</b>	<b>1d6</b>	<b>LEATHERS (HEAD)</b>		<b>SP 4</b>									
<b>MEDIUM MELEE WEAPON</b>				<b>ROF2</b>	<b>2d6</b>	<b>LEATHERS (BODY)</b>		<b>SP 4</b>									
<b>SKILL BASES</b>																	
Acting 10 • Athletics 7 • Brawling 7 • Concentration 7 • Contortionist 9 • Conversation 9 • Dance 8 • Education 11 • Evasion 7 First Aid 6 • Human Perception 9 • Language (Native) 10 • Language (Streetslang) 8 • Local Expert (University District) 8 Melee Weapon 12 • Perception 8 • Personal Grooming 10 • Persuasion 10 • Stealth 10 Streetwise 9 • Wardrobe & Style 10																	
<b>GEAR</b>																	
Disposable Cellphone																	
<b>CYBERWARE</b>																	
Nasal Filters • Shift Tacts • Techhair																	

<b>NAME</b>	<b>THE CLOWN</b> (REP 1)			<b>SERIOUSLY WOUNDED</b>	<b>18</b>	<b>HP</b>	<b>35</b>										
<b>ROLE</b>	<b>NONE</b>			<b>DEATH SAVE</b>	<b>4</b>												
<b>STATS</b>																	
<b>INT</b>	<b>4</b>	<b>REF</b>	<b>7</b>	<b>DEX</b>	<b>4</b>	<b>TECH</b>	<b>7</b>	<b>COOL</b>	<b>6</b>	<b>WILL</b>	<b>5</b>	<b>MOVE</b>	<b>6</b>	<b>BODY</b>	<b>4</b>	<b>EMP</b>	<b>1</b>
<b>WEAPONS</b>								<b>ARMOR</b>									
<b>HEAVY PISTOL</b>				<b>ROF2</b>	<b>3d6</b>	<b>L ARMORJACK (HEAD)</b>		<b>SP 11</b>									
<b>AIR PISTOL</b>				<b>ROF2</b>	<b>—</b>	<b>L ARMORJACK (BODY)</b>		<b>SP 11</b>									
<b>SKILL BASES</b>																	
Athletics 6 • Brawling 9 • Conceal/Reveal Object 7 • Concentration 7 • Contortionist 7 • Conversation 3 • Education 6 Evasion 9 • First Aid 9 • Handgun 12 • Heavy Weapons 12 • Human Perception 3 • Interrogation 12 • Language (English) 8 Language (Streetslang) 8 • Local Expert (South Night City) 6 • Melee Weapon 9 • Perception 10 • Persuasion 8 • Stealth 6																	
<b>GEAR</b>																	
Heavy Pistol Ammo x8 • Acid Paintball x16 • Poison Arrow x2 (in Cybereyes) • Rubber Arrow x2 (in Cybereyes) Disposable Cellphone																	
<b>CYBERWARE</b>																	
MultiOptic Mount • Cybereye x6 w/ Anti-Dazzle, Low Light/Infrared/UV, Dartgun x4																	

SEE PAGE 188 FOR BIOGRAPHY

# A NIGHT AT THE OPERA

SEE PAGE 188 FOR BIOGRAPHY

<b>NAME</b> THE MONK (REP 1)	<b>SERIOUSLY WOUNDED</b> 23	<b>HP</b> 45
<b>ROLE</b> NONE	<b>DEATH SAVE</b> 6	

**STATS**

INT 6 REF 7 DEX 6 TECH 3 COOL 4 WILL 7 MOVE 6 BODY 6 EMP 1

<b>WEAPONS</b>			<b>ARMOR</b>	
EXCELLENT QUALITY HEAVY PISTOL w/ EXTENDED CLIP	ROF2	3d6	KEVLAR® (HEAD)	SP 7
			KEVLAR® (BODY)	SP 7

**SKILL BASES**

Athletics 12 • Brawling 12 • Concentration 9 • Conversation 3 • Education 10 • Endurance 11 • Evasion 12 • First Aid 5  
Handgun 15 • Human Perception 3 • Language (English) 8 • Language (Streetslang) 10 • Local Expert (South Night City) 8  
Perception 9 • Persuasion 6 • Resist Torture/Drugs 13 • Stealth 8 • Tactics 10 • Wilderness Survival 10

**GEAR**

Expansive Heavy Pistol Ammo x14 • Disposable Cellphone

**CYBERWARE**

None

<b>NAME</b> BOZO MOOK (REP 0)	<b>SERIOUSLY WOUNDED</b> 15	<b>HP</b> 30
<b>ROLE</b> NONE	<b>DEATH SAVE</b> 4	

**STATS**

INT 4 REF 7 DEX 6 TECH 5 COOL 4 WILL 3 MOVE 5 BODY 4 EMP 2

<b>WEAPONS</b>			<b>ARMOR</b>	
POOR QUALITY SHOTGUN	ROF1	5d6	SKIN WEAVE (HEAD)	SP 7
BRAWLING	ROF2	1d6	SKIN WEAVE (BODY)	SP 7

**SKILL BASES**

Athletics 8 • Brawling 11 • Conceal/Reveal Object 8 • Concentration 5 • Conversation 4 • Demolitions 9 • Education 6  
Evasion 10 • First Aid 7 • Heavy Weapons 11 • Human Perception 4 • Language (Native) 8 • Language (Streetslang) 6  
Local Expert (South Night City) 6 • Perception 6 • Persuasion 6 • Shoulder Arms 8 • Stealth 8 • Streetwise 7

**GEAR**

Slug Ammo x10

**CYBERWARE**

Nasal Filters • Shift Tacts • Skin Weave • Techhair

# A NIGHT AT THE OPERA

<b>NAME</b>	INQUISITOR MOOK (REP 0)			<b>SERIOUSLY WOUNDED</b>	15	<b>HP</b>	30										
<b>ROLE</b>	NONE			<b>DEATH SAVE</b>	2												
<b>STATS</b>																	
<b>INT</b>	4	<b>REF</b>	6	<b>DEX</b>	7	<b>TECH</b>	2	<b>COOL</b>	5	<b>WILL</b>	6	<b>MOVE</b>	6	<b>BODY</b>	2	<b>EMP</b>	4
<b>WEAPONS</b>				<b>ARMOR</b>													
VERY HEAVY PISTOL				ROF1	4d6		LEATHERS (HEAD)		SP 4								
BRAWLING				ROF2	1d6		LEATHERS (BODY)		SP 4								
<b>SKILL BASES</b>																	
Athletics 13 • Brawling 13 • Concentration 8 • Conversation 6 • Education 6 • Evasion 9 • First Aid 4 • Handgun 11, Human Perception 6 • Interrogation 8 • Language (Native) 8 • Language (Streetslang) 8 • Local Expert (South Night City) 6 Perception 6 • Persuasion 7 • Resist Torture/Drugs 10 • Stealth 11																	
<b>GEAR</b>																	
Very Heavy Pistol Ammo x16																	
<b>CYBERWARE</b>																	
None																	

<b>NAME</b>	LORD RUTHVEN, NIGHT PREDATOR (REP 2)			<b>SERIOUSLY WOUNDED</b>	25	<b>HP</b>	50										
<b>ROLE</b>	MEDTECH: MEDICINE 4 (SURGERY 4)			<b>DEATH SAVE</b>	10												
<b>STATS</b>																	
<b>INT</b>	5	<b>REF</b>	8	<b>DEX</b>	8	<b>TECH</b>	4	<b>COOL</b>	5	<b>WILL</b>	6	<b>MOVE</b>	8	<b>BODY</b>	10	<b>EMP</b>	0
<b>WEAPONS</b>				<b>ARMOR</b>													
VAMPYRES				ROF2	1d6		SUBDERMAL (HEAD)		SP 12								
EXCELLENT QUALITY WOLVERS x2				ROF2	3d6		SUBDERMAL (BODY)		SP 12								
<b>SKILL BASES</b>																	
Acting 10 • Athletics 16 • Basic Tech 12 • Brawling 16 • Conversation 2 • Cybertech 12 • Education 7 • Evasion 16 First Aid 6 • Human Perception 2 • Interrogation 14 • Language (English) 13 • Language (Streetslang) 9 Local Expert (University District) 10 • Melee Weapon 18 • Paramedic 10 • Perception 12 • Personal Grooming 11 Persuasion 12 • Resist Torture/Drugs 14 • Stealth 16 • Surgery 12 • Wardrobe & Style 12																	
<b>GEAR</b>																	
Agent • Vial of Biotxin (in Vampyres)																	
<b>CYBERWARE</b>																	
Cybereye x2 w/ Low Light/Infrared/UV • Grafted Muscle & Bone Lace • Neural Link w/ Chipware Socket x2, Kerenzikov, Pain Editor • Subdermal Armor (Tech Upgraded to 12 SP) • Wolverers x2 (Tech Upgraded to Excellent Quality) Vampyres																	

SEE PAGE 188 FOR BIOGRAPHY

**YOUR  
WATER**



**CACTUS  
WATER**



**IF IT ISN'T GREEN IT ISN'T CLEAN**

**YOUR LIFE  
SUCKS!**



**MILITECH**

**SO GO JOIN**

**& CHANGE IT!**

**bite into the  
forbidden**



*Dracula*

@ the Night City Symphony Hall



# AGENTS OF DESIRE

## BACKGROUND (READ ALOUD)

*As a team of professional troubleshooters—Edgerunners—your team has had its share of interesting jobs, some legal, most not. This one seems to be pretty straightforward—a local Fixer—someone who arranges employment between people like you and people who need problems solved—has sent a ping to your group requesting help in rescuing a kidnapped woman from an unknown group. It’s a simple extraction; you’ve done dozens before. No big thing, right?*

## THE REST OF THE STORY

There’s definitely more here than meets the eye. The Client has lost his fiancée, true. But there’s a lot of loose ends attached to this job. Who grabbed her and why? How did they do it from a very secure, very exclusive restaurant? Why doesn’t anyone seem to know anything about the missing girl? How is she managing to call the Crew from underneath the kidnapper’s noses the whole time?

The situation revolves around the Client, Kodai Khan, and his fiancée, Ai. Both Kodai and Ai are ex-Arasaka agents, who fell in love shortly before the 4th Corporate War. When the Night City nuke went off and Arasaka toppled, they both struggled to find employment with other corporations. Eventually, after years of tough freelance work, Ai found a position with 4overTechnologies, a mid-level firm specializing in customer support databases and information recovery, and Kodai with the mass media megacorp Ziggurat. This change of employment put a strain on their relationship. Eventually the stress of middle management in Ziggurat and Ai’s reluctance to officially get married warped Kodai’s perception of his loving girlfriend. He became convinced that she was going to leave him for another Corp at 4overTechnologies. As Kodai’s paranoia festered and he got more and more cyberware for his job at Ziggurat, he eventually developed a mild case of cyberpsychosis.

Kodai determined that the only way to keep Ai was to have her soulkilled to create an AI of his beloved girlfriend who would always love him. Using his old Arasaka connections, Kodai contacted a brilliant Tech named Lotus LeMarch, who he blackmailed into using an old copy of the soulkiller program stored in an Arasaka bunker to create an engram of Ai and put it onto his personal Agent. Kodai had LeMarch upgrade

his Agent to link into his Cyberoptics and Cyberaudio and create a projection of Ai which only he could see or hear. The act of having Ai soulkilled pushed Kodai completely over the edge and in psychological self-defense he formed an alternate narrative in which he and Ai were engaged and living happily in his conapt. He’s continued to live in this fantasy for years, perpetually in the giddy days before his wedding, living with his loving, devoted fiancée.

This went perfectly fine, until a few days ago when he was having a dinner date with Ai at La Lune Bleue and his agent was stolen by a group of upscale pick pockets called the High Class Heist Crew. Now, Kodai is desperately searching for his girlfriend, who he thinks is still alive and well, while the High Class Heist Crew are using their server farm hideout to make hundreds of copies of the engram of Ai to sell at Night Markets across Night City.

## THE SETTING

The Crew begins the adventure with a stop by the famous solo bar, the Forlorn Hope, where they’ll pick up a job from Solo-Turned-Fixer Rogue Amendiares. The job will take them to the up-scale conapt of Ziggurat Corporate Executive Kodai Khan. There they’ll interview Kodai for information on his missing fiancée and get a few leads.

After a bit of searching around, the Crew will wind up at La Lune Bleue, a high end restaurant in the Upper Marina where they’ll be probably cause some commotion as the kidnapers try to get them off their tail. With no other solid leads, the Crew will likely wind up back at Kodai’s conapt where they’ll do a bit more snooping around before they get ambushed by the kidnapers. This leads the Crew to either the kidnapers’ hideout, where they’ll find Kodai’s fiancée, Ai, or the workshop of Elite Technologist Lotus LeMarch, where they’ll learn the rest of the story of Ai’s kidnapping.

## THE OPPOSITION

- **Maurice**, Maitre’d au La Lune Bleue is the gatekeeper at the exclusive La Lune Bleue restaurant. He’s the kind of obstacle you can’t beat with a gun or a threat. You’re going to have to get smart to get around him.

- **La Lune Bleu Security** are the meat behind Maurice's snark. Large, well-muscled men in subdued suits, perfectly willing to pick you up and throw you down the La Lune's elevator shaft. Quietly, so as not to disturb the customers.
- The **High Class Heist Crew** are a gang of thieves who have been lifting valuables from expensive venues all over town. Mad skills in both theft and tech.
- **Lotus LeMarch**, the "Elite Technologist" is a highly skilled professional whose forte is providing one of a kind personal technology to his very exclusive clientele. He's like Eran Malour, but with gear instead of guns.
- **Saturday Night Butt-kickers** are Local thugs for hire. They do it for money, sure. But they'd do it anyway for an excuse to kick your butts around the block. Big. Violent. But strangely light-hearted about it. They'll be cracking jokes while trashing your face.

## THE HOOK

Your Crew has been contacted by Rogue Amendaires, a Fixer with a heavy-duty rep as a one-time Solo. And she's just pinged your "leader" (You can let the Crew decide who that will be) via Agent that she wants to set up a meeting. She says she has been approached by a wealthy Client who has a problem she thinks the Crew can solve. It sounds like a low-level extraction—get in, grab the target, and get out with a minimum of fuss and gunfire. Just the sort of job a bunch of newly hatched Edgerunners like you should be able to handle. But you'd better hustle—opps like this don't come along every day, and Rogue is known to be impatient at the best of times.

You meet up in a bar known as the Forlorn Hope. Everyone knows that Rogue usually takes clients in the Afterlife but that's only for proven Edgerunners and you haven't proven yourselves yet. Unlike the loud, night club atmosphere of the Afterlife, the Forlorn Hope is a quiet neighborhood bar. It's down a few stairs below street level, in a cozy three rooms with a well-stocked bar to one side. The clientele is mostly a mix of hard-bitten Edgerunners, experienced military or law enforcement pros, and some of the best Solos in the Greater Night City region. As one time Queen of the

BY SANTIAGO BETANCUR



Rogue Amendaires

Solos, it makes sense that the Rogue would choose this bar to meet up-and-coming talent. Assuming that the actual owners of the Hope (Marianne Russell Freeman and her husband, aka "The Professor") approve.

Nobody, not even Rogue, crosses Marianne.

You work your way through the overly warm, somewhat crowded main bar area, trying to not bump into anyone in the way. The place is filled with high-powered players, any one of which could probably murder the entire Crew without breaking a sweat. On the other hand, just being seen here with Rogue is going to give your Crew a real boost in street cred, so you settle for looking as badass and mean as you can as you head to the booth in the back where she holds court.

Your benefactor is a tall, teal-haired woman of indeterminate age (you might hazard around mid-thirties although she's actually much older). She's leaned back in a booth dimly lit by a single table torch; as you get closer, those of you with cybervision can detect the low hiss of a local Hush sound generator that encompasses the whole booth area. The lady values her privacy, not to mention the privacy of her clientele.

Rogue is all business. She has a rough, somewhat deep voice that sounds like a late-night DJ who's smoked too many cigarettes. She gestures at the Crew to come over to the booth she's using as her "office," sharp gray eyes appraising closely as they approach.

*"Nice of you gonks to finally show up. Couldn't find a Combat Cabb to haul your arses over here? I said this was time sensitive, and I meant it. Sit down and I'll fill you in—no, wait a second—you keep standing. You made me wait—I'll make you stand."*

*"The job is pretty simple; kind of thing I like to throw newbs like you at to see if you can handle anything bigger. Client calls me up and says his mainline has been snatched. He's pretty high up in the ranks at Ziggurat, and he thinks maybe someone grabbed her to put pressure on him to spill company secrets. He wants you to check out the kidnap site; scan for clues, and then find out who has her and where they are. If the oppo looks heavy duty, report back to me and I'll ask a few of the regulars at the Hope to give you a hand. Understood?"*

The Crew may have a few questions. Here are a few of the most common ones. You can probably fake any other weird ones like, "Where do you get your hair done?"

## ► IS THIS GUY GOOD FOR THE MONEY?

*"What?! You want to tell me my business? Look, peanut head—I've checked out the client's deets, and he's legit. He's a high up corp Exec; made serious bank and he's heavy with ebs."*

## ► DID ANYONE ELSE SEE THIS KIDNAPPING?

*"The Client and his input were at a really upscale place—La Lune Bleue in the Upper Marina. Exclusive; you chooms wouldn't be able to even buy drink there. Far as I know, no one saw anything, but hey, if someone was extracted from under their noses, do you think La Lune Bleue would tell anyone?"*

## ► DO YOU HAVE ANY GEAR WE CAN USE?

*"Are you kidding me? I thought you were professionals (withering disdain here). You think you're going to need an AV4 and a couple anti-tank missiles to check out a simple snatch and grab?!? Sweet Buddah, save me from blankchips!"*

## ► CAN WE GET ANY MONEY AHEAD OF TIME TO DO THIS?

*"The Client has given me a retainer of 1000eb. I want it back when this is over. And before you get any cute ideas, remember what I used to do before I made this career change."*

The point is, Rogue figures the Crew can handle this or she wouldn't be wasting her valuable time briefing them. She's not going to give them any more help or gear—pros don't need the Fixer getting mixed up in the job. And you're supposed to be pros.

At the end of the questions, she flips one of you a memory chip, adding: "The Client's realspace is on the chip."

If the Crew hesitate to get going at all she adds, "What? I gotta hold your hand for a trip across town? Get out of here before I decide to give the gig to the local Reclaimer Girl Scouts. Move!"

## GO TO DEV (FISH OUT OF WATER)

### DEV (FISH OUT OF WATER)

The Client lives in a very exclusive conapt in the Upper Marina. The place reeks of sophistication and money; it was built out of a reconstructed set of law offices from before the War; wrought iron railings, an open glass elevator in the style of a 1900s hotel. As you step into the tiled and wood-paneled lobby, sharp eyed security Solos watch you closely. When you come up to the apartment call display and punch in the access code on the chip Rogue gave you, the response is almost immediate.

A young man's voice, sounds about late twenties to early thirties, answers. He says nervously, "I'll unlock the elevator; you can come up." As you head to the lift, your feet making way too much noise in the quiet lobby, the door opens and the glass and iron box lifts you up five stories to a series of wood-paneled apartment doors. Apartment #554 opens as you approach, and a face peers out. This is the client, and he waves you in.

The apartment has an open view over the new Harbor Canal, all the way over to where the construction drones are raising the scaffolding on the Watson megabuilding. The afternoon light streams through the glass, revealing a tasteful, open concept multilevel apartment with very expensive, modern style

furnishings. There are a few books scattered around; mostly tech journals and the equivalent of catalogs for exclusive goods—the fact that they’re actually on paper instead of just dumped to a datapad from the ‘Pool should tell you something.

The client, Kodai Khan (**SEE PAGE 36**) explains that his fiancée, Ai, has been kidnapped. Last time he saw her, she was having dinner with him in a very exclusive restaurant. He stepped away from the table to go to the bathroom and when he returned, she was gone. He thinks she’s been kidnapped and is willing to pay a rather sizable reward of 1,000eb per person if they can get her back.

*“Are you the people Ms. Amendiara sent? Thank you for coming so soon.”*

He sits down shakily on the very expensive, real-leather sofa; gestures for the Crew to join him on the chairs surrounding the glass tabletop. He spreads his hands and launches into a nervous conversation.

*“I really need your help. This is something I can’t even involve Ziggurat in. It’s too... personal. Someone has kidnapped my fiancée, Ai. I don’t know why, and I don’t know who. I thought it might be a corporate extraction, but Ai isn’t working on anything important; she’s just handling basic administrative stuff; technical cleanup and the like. I mean, why would anyone want to extract her?”*

*“It must be personal. Although for the life of me I can’t think who would hate me like this. I’m not that important in Ziggurat; I do system design, but nothing that isn’t done by anyone else in my division. All I know is, I have to get Ai back. I’ll pay anything the kidnapers want, but when I put a call out on the Data Pool, Ms. Amendiara contacted me and said your group would be able to—to rescue Ai.”*

The Crew will probably have a few questions they’ll want to ask before setting out on the job.

## ▶ DID AI HAVE ANY ENEMIES?

*“Of course not! Ai’s the sweetest thing. I don’t think anybody could be mad at her if they tried!”*

## ▶ DO YOU HAVE ANY ENEMIES?

*“No one who would do something like this. Every Exec makes some enemies, but they’d just undercut my team or try to make me look bad to the regional managers.”*

BY DANI HARTEL



Kodai Khan

BY DANI HARTEL



Aisha “Ai” Tiang

## LEADS ON AISHA

When Kodai had Ai Soukilled he also had Lotus LeMarch track down as many loose ends regarding Ai as he could. As far as 4overTechnologies knows, Aisha quit a decade ago, and the records of the Police investigation into Aisha's disappearance was buried. To find out that Aisha Tiang was found dead requires a DV 24 Library Search Check. If the Crew succeeds at this Check, **GO TO OPDEV (DEAD ENDS)**.

### ▶ DID YOU AND AI HAVE ANY PROBLEMS?

*"Absolutely not! We're made for each other. We got engaged last year and we were planning for the wedding in the fall."*

### ▶ WHO DO YOU THINK MAY HAVE DONE THIS?

*"I really have no idea. That's why I reached out to Rogue. I've heard some stories about a gang of thieves called the "High Society Heist Club"? But it sounds like they just steal jewelry and things. People think they've hit the restaurant Ai and I went to."*

### ▶ WHEN DID YOU NOTICE SHE WAS MISSING?

*"As soon as I got back from the restroom! I was only gone for a few minutes! I asked the busboy where she went and he said he hadn't seen anyone that looked like Ai!"*

### ▶ WHERE DID THIS HAPPEN?

*"The La Lune Bleue. It's a nice French restaurant in the Upper Marina."*

### ▶ WHAT DID YOU DO AFTER?

*"I asked a busboy if he had seen her leave and when he said he hadn't seen her I went outside to look for her. I couldn't find any trace of her though. I was in the restroom so I would have heard if anybody went in or out of the other restroom."*

While talking to the Crew, Kodai receives a call on his company Agent from Ai.

## THE PHONE CALL

*"(gasp) Is this Kody? Please, let this be Kody! It's Ai! I really need you! I really need you! I've been kidnapped and I don't know where I am! They just scooped me up and put a bag over me when I was in the restaurant! I don't know what they want! I'm locked in a room! They didn't notice your Agent has an autodial to your work Agent—I'm calling you before they figure out what I'm doing! Help me, Kody! Find me, please! Save me! I need you!"*

Ai tells Kodai she is being held in an undisclosed location; she is terrified and desperately wants Kodai to rescue her. She is increasingly more desperate and then the calls are cut short by a rough male voice that orders her to shut up. Kodai is understandably upset, but is willing to pay the kidnapper whatever he wants. Surprisingly, the kidnapper doesn't ask for a ransom. Instead, the ominous voice hangs up.

Kodai will let the Crew take his work Agent as they hunt down Ai. Over the course of the investigation, the Crew will get increasingly frantic calls from Ai as she tries to figure out where she is. They can see her face as a small holo on the screen whenever she calls.

Here are a sample of a few desperate messages from Ai that you can use to rile up your Players.

- "I'm Terrified."
- "I'm so Miserable."
- "I'm in Pain."
- "I'm scared of the dark."
- "They're doing something to me!"
- "I can't stand it; I just want to die!"
- "Why won't you come? Don't you love me anymore, Kodai?"

Pepper in a few of these calls whenever things seem to be slowing down or the Crew seems unmotivated. If the Crew responds to Ai's messages she seems disoriented and is unable to give much information. If the Crew succeeds at a DV 15 Conversation Check, they learn the following information: Ai can't see anything and the only thing she can hear is the sound of computers and beeping. She doesn't have any further details about what was happening when she was grabbed or how she was abducted, but she can tell the Crew that Kodai's agent was upgraded by a Tech named Lotus

LeMarch. He might be able to trace it. If, at any time, the Crew decides to chase down Lotus LeMarch, **GO TO OPDEV (THE ELITE TECH)**.

## GO TO DEV (PREPARATION)

### DEV (PREPARATION)

Assuming the Crew hasn't talked with Ai and learned about LeMarch, the next best step is to investigate the scene of the crime: La Lune Bleue. With a DV 13 Library Search Check, the Crew can extract some info about the crime from the Data Pool. Alternatively, a DV 15 Streetwise Check will allow the Crew to get the same information from contacts on the street. This research tells the Crew that there's a gang that frequents expensive restaurants and clubs like the one where Ai and Kodai were eating. The gang, disguised as waiters or other servants, is known for stealing purses and other expensive items from diners and clubgoers.

If the Crew digs deeper into the Data Pool with a DV 15 Library Search they learn that a week ago La Lune Bleue filled a position for a new waiter, and then opened a position for another new waiter the night of the kidnapping. Making the former likely a member of the High Class Heist Crew.

The job postings on the Data Pool won't tell the Crew who applied for the job and then subsequently quit, meaning that if they want to chase down this lead they'll have to get access to the restaurant's files. To do that they'll need to get inside the restaurant and hack into their NET Architecture. This would also give them access to the security camera recordings.

If the Crew tries to contact La Lune Bleue directly as investigators, **GO TO CLIFF (THE GATEKEEPER)**. If the Crew decides, instead, to infiltrate the restaurant, **GO TO CLIFF (A HIGH CLASS JOINT)**.

### CLIFF (THE GATEKEEPER)

If the Crew tries to contact La Lune Bleue about their security camera footage or their hiring recordings, they wind up in contact with the Maitre'd, Maurice. The smart move is to call the restaurant instead of going down in person. Over the phone, Maurice has a harder time judging the Crew before addressing them. He gives the

Crew a well-practiced introduction, touting La Lune Bleue as the finest French cuisine on the West Coast, and asks if the Crew is intending to make a reservation.

If the Crew asks about the security cameras, their staff, or try to explain that they're searching for a missing woman, Maurice gets snippy, saying *"THAT, sir/madam (and I use this term most loosely) is privileged information. Sniff around somewhere else. I will not have you ruining the reputation of La Lune Bleue."* Maurice then hangs up.

If the Crew doesn't immediately jump to their questions, and instead plays along, they can attempt to get the information out of Maurice subtly. With a DV 15 Conversation Check, the Crew can ask a question before Maurice finishes making their reservation.

However, if the Crew goes directly to La Lune Bleue, they are met by Maurice at the front of the house. He looks the Crew over, checks their names (or aliases) against his rather extensive database of Who Is Worthy in Night City, sniffs, and suggests that they try a nearby place that would be more to their liking. He'll probably suggest the following based on how the Crew is wearing when they arrive.

#### ▶ BUSINESSWEAR OR HIGH FASHION

*"Ahem. I think I may have an opening at a nice table near the upper gallery. Of course, it's only for two, so the rest of your party will either have to wait for a table or go elsewhere. Ahem."*

#### ▶ URBAN FLASH

*"Ah. It seems the Red Crustacean is closed for the night. Might I suggest the Olive Gazebo for a change of culinary pace?"*

#### ▶ ANYTHING ELSE

*"I'm sorry, but the garbage pickup is supposed to be tomorrow night. Perhaps you should come back then—preferably by the service entrance this time."*

If the Crew is wearing Businesswear or High Fashion, Maurice willingly talks to them as he seats them. He still isn't interested in speaking about anything that might portray La Lune Bleue in a bad light, however. It requires a DV 17 Conversation or Persuasion Check to get him to answer any questions about La Lune Bleue's

# AGENTS OF DESIRE

operations or anything related to a crime. If the Crew pushes Maurice or he begins to suspect that they're just at La Lune Bleue to investigate he politely asks them to leave.

Here are a few of Maurice's responses.

## ▶ CAN WE LOOK OVER SECURITY CAMS?

*"Why ever would you need to see the security camera footage? La Lune Bleue is the safest restaurant in Night City. The restaurant is guarded 24/7 by the finest guards money can buy."*

## ▶ DO YOU RECALL SEEING THIS WOMAN?

*"I do not recall having seen a woman by that description. I certainly would have remembered if I had. Hardly proper attire for La Lune Bleue."*

## ▶ HAVE THERE BEEN ANY DISTURBANCES HERE?

*"La Lune Bleue is a haven from the chaos of Night City. Nothing ever goes wrong within the walls of this establishment. Our customer satisfaction rating is second to none."*

## ▶ WHO WAS THE WAITER THAT YOU RECENTLY FIRED?

*"You must be referring to the posting on the Data Pool. No one was fired because we never hire anyone incapable of being anything but extraordinary. They simply*

*chose to find employment elsewhere. If you're asking on behalf of a friend, we are indeed looking for a new server. Only the best for La Lune Bleue."*

Of course, if the Crew is wearing anything but Businesswear or High Fashion, Maurice immediately disregards them and cannot be convinced to answer any questions.

If the Crew presses the issue or refuses to leave, Maurice will make a quiet gesture and La Lune Bleue Security (A number equal to the Crew, Use **Bodyguard**, PAGE 172; add Microwaver) will attempt to calmly and forcibly remove the Edgerunners.

## GO TO CLIFF (HIGH CLASS JOINT)

## CLIFF (HIGH CLASS JOINT)

If the Crew hasn't already managed to get into La Lune Bleue by wearing the right clothing and playing along, they'll have to find another way to get into the restaurant. Additionally, they'll have to keep the staff busy while someone retrieves the security cam footage and the registry. They don't want to be really obvious about it, as the place is exclusive and has its own response security Crew (which they may have met already if they tried to bully their way in). The Crew has a few obvious options available.

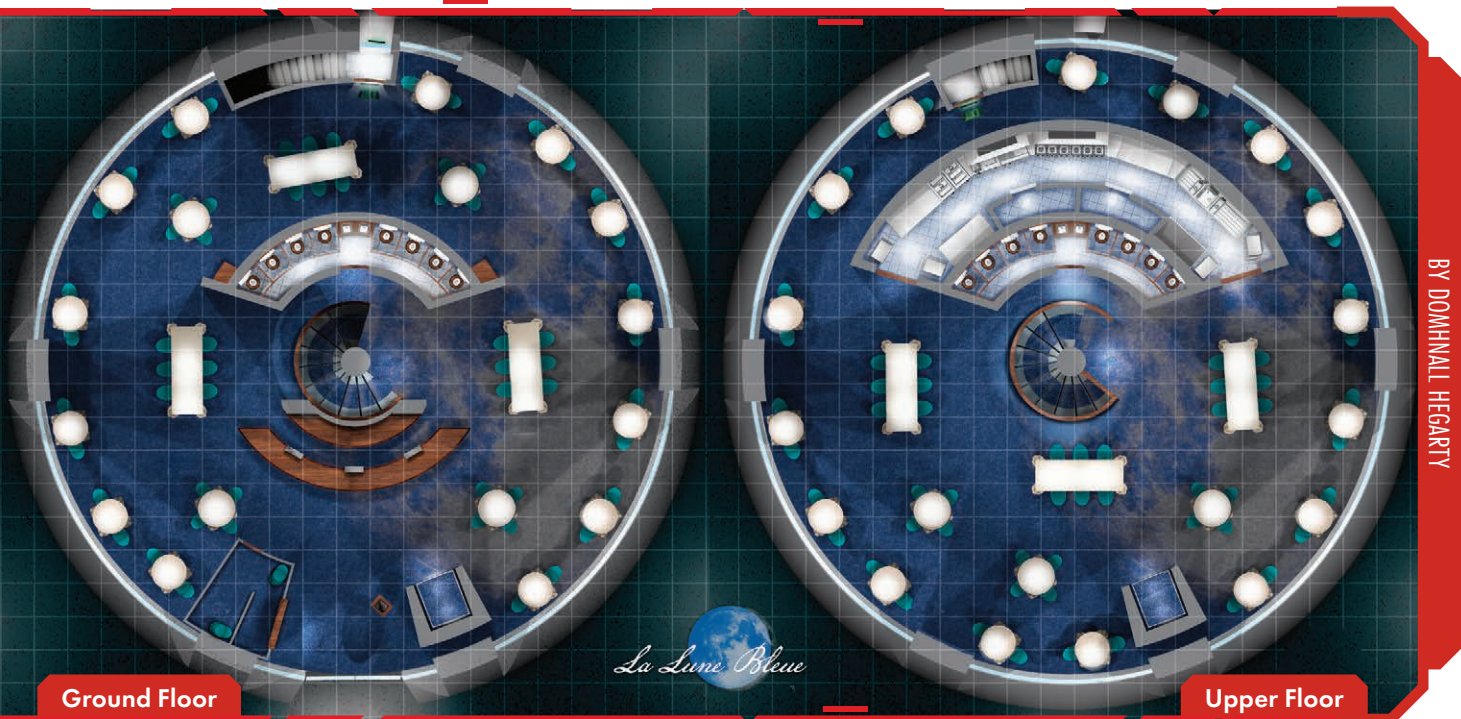

BY DOMINALL HEGARTY

Ground Floor

Upper Floor

- If the Crew applies to the open waiter position, they could get up to 3 members in as new wait staff. However, if they confronted Maurice, they must make a DC 17 Persuasion Check to get him to hire them. If the confrontation escalated to violence or the Crew made it clear they are investigating, Maurice refuses to hire them as waiters.
- If the Crew gets the right clothing (**SEE CLIFF [THE GATEKEEPER] FOR MORE INFORMATION**), they could get a table at the restaurant. However, a meal for one at La Lune Bleue costs 500eb so they'll have to be ready to pay up or dine and dash. If the Crew made it clear to Maurice that they were investigating something, he tells the security guards to keep a close eye on the Crew and if they get violent when they confront Maurice, he refuses to seat them. Still, Rogue may front them some funds if they see this as the only way to move forward.
- With a DV 17 Acting Check, an Edgerunner could pose as assistants/servants of one of the high rollers in the restaurant and get in that way. If they spoke to Maurice at all before this attempt the DV goes up to 21 and if they confronted Maurice or made it clear they're investigating something, Maurice refuses to let them in.

## HACKING INTO LA LUNE BLEUE

Without a Netrunner, the Crew will need to do things the old fashioned way. A DV 15 Stealth or Persuasion (if the Character is a waiter) Check is required for an Edgerunner to directly access the terminal. Any Crew member can attempt a DV 15 Electronic/Security Tech Check to break into the security systems. After this, a DV 13 Library Search Check is required to

find the Security Camera records or the staff records. Finally, to actually open these files requires a DV 17 Electronic/Security Tech Check. Once the Edgerunner is in, either of these files can be accessed on the terminal or copied to a memory chip. Each of these Checks requires one minute to complete. During each Check, have a member of La Lune Bleue Security (use **Bodyguard, PAGE 172**) make a DV 15 Perception Check. If the guard succeeds, they approach the Edgerunner to see what they're doing. The Crew can defuse the situation with a Persuasion Check (DV 15 if they are a waiter, DV 21 if they are a guest). If they fail to defuse the situation **GO TO CLIFF [DINE AND DASH]** and modify to fit the situation as needed.

A Netrunner can, of course, try to do things at a more rapid pace by interfacing directly. There are two access points to the La Lune Bleue NET Architecture. One is located behind the bar on the bottom floor and the other is located in the kitchen on the top floor. With a DV 15 Stealth Check a Netrunner can linger near one of these access points without being noticed allowing them to jack into the NET Architecture and take their time. Otherwise, they've got 30 seconds (10 Rounds) before restaurant security notices them.

### GO TO DEV (STRANGE RECORDS)

## DEV (STRANGE RECORDS)

Assuming that the Crew gets into the restaurant's files, they can access the camera and employment records.

If they scroll back to the night of the kidnapping they can pinpoint Kodai sitting at a table on the second floor but they don't see Ai. If they scroll all the way back to when Kodai and Ai entered the restaurant, they see Kodai being led to the table and obviously interacting with Ai, but they don't see her. As they watch the night progress, Kodai chats with Ai, laughs, and has the

## THE HIGH CLASS HEIST CREW

*The High Class Heist Crew is hardly what you'd expect from a gang of smash and grabbers. In fact, they are all college students from the nearby Night City University. They're trying to make enough ebs to cover their student loans and took up theft to fence expensive stolen items. Since most of them are in technical fields, they're pretty adept at rigging ways to circumvent security systems. And the Drama students taught them how to blend in and pick pockets. Which is probably the only thing you can do with a Drama degree. Each member of the crew has a fake name they use in public which is usually a nondescript first name and the last name of a famous literary figure.*

waiter bring two glasses of wine for the pair of them, but Ai is never visible. Part way through the night, Kodai excuses himself and gets up, leaving his phone on the table and heading to the bathroom. Moments later, a waiter slips by the table and smoothly pockets Kodai's phone as he takes away a basket of bread. When Kodai returns, he looks around, growing increasingly concerned. He speaks to a busboy and begins panicking, heading for the door.

Did the kidnappers remove the visual evidence from the cam record? It's possible that a skilled Netrunner could have coded a Virus to alter the video and remove the evidence of Ai's kidnapping. Alternatively, at a high-level place like La Lune Bleue, the patrons don't always want anyone to know they're there—they could be holding secret business dealings, meeting lovers for affairs, plotting murders... you get the idea. If a Netrunner in the NET Architecture makes a DV 6 Pathfinder Check they discover that there is no tampering in the system.

If a character tries to gauge the reaction of Maurice as he seats Kodai and Ai they can make a DV 17 Human Perception Check. If they succeed, they notice that while he is concealing it very well, Maurice is obviously off-put by the situation and only ever speaks to Kodai.

If the Crew checks the employment records of La Lune Bleue, they are able to find the waiter who quit the night of the kidnapping. He is registered as Kevin Dickens and if the Crew has already checked the camera footage they can match him to the waiter who stole Kodai's phone. They are able to find a street address for Mr. Dickens, as well as an Agent number. For future reference, if the Crew tries to call the Agent the number is disconnected and the Street address leads to an abandoned, burned-out building in the Old Combat Zone.

## GO TO CLIFF (DINE AND DASH)

### CLIFF (DINE AND DASH)

At some point, as the Edgerunners are investigating the restaurant, one of the wait staff bumps into a member of the Crew, nearly spills a drink on them, makes profuse apologies, wipes up any mess, and moves on. If the Characters succeed at a DV 21 Perception Check or peeks in their pockets, they realize that the waitress slipped

them an Agent. If the Edgerunners attempts to confront the waitress, she immediately starts shouting about how they saw one of the Edgerunners steal a guest's Agent.

This is Jane Gatsby (**SEE PAGE 36**), a member of the High Class Height Crew who stayed at La Lune Bleue to scout for future targets and she's flagged the Crew as potential rival thieves. If she succeeded in planting the Agent, she maneuvers her way back to the staff entrance, informs security about the "stolen Agent" and makes her escape. If not, she's just made a ruckus by loudly accusing the Crew of theft in the middle of the dining area.

Any attempt to defuse the situation will automatically fail. Jane has spent the last few weeks ingratiating herself to La Lune Bleue's staff: taking extra hours, covering people's shifts, bringing the guards snacks, and complimenting Maurice constantly. As far as they know, Jane Gatsby is a saint. Fortunately, only the Edgerunner in possession of the "stolen Agent" and anyone obviously connected to them will be fingered. Anyone not directly connected won't be a suspect.

If the fingered Edgerunners give themselves up, security (use **Bodyguard, PAGE 172**) will round them up and hand them over to the NCPD who will no doubt charge them for a series of thefts committed by the High Class Heist Crew. After a night in jail, the Crew will have to bail any comrades out (at a steep 500eb each), perhaps by going to Rogue for help. She'll get them set free, but sends them an ultimatum. "*Fuck up again and you are done in this city.*"

If they draw weapons or threaten the diners, the restaurant staff will immediately call the NCPD. With the call coming from an upscale restaurant in the Upper Marina, the NCPD will dispatch a number of **Security Operatives (SEE PAGE 173)** equal to the Crew plus 2 who arrive in 3 Rounds.

Their last option is to evade the high-end security in the restaurant and escape. The Security guards won't draw their guns, but they are quite skilled in hand-to-hand combat and will use their Microwavers to subdue Crew members with obvious cyberware.

No matter what, the Crew should continue their investigation. Some possibilities are covered by the following Optional Developments and Cliffhangers. If any of the Crew's avenues of investigation lead to the climax of the mission directly, **GO TO CLIFF (HEADBREAK TONIGHT)**.

## **PDEV (INTERROGATION)**

If the Crew manages to somehow capture Jane Gatsby and transport her to a safe location, they can interrogate her for information regarding Kodai and Ai. Jane is a college student, stealing from the rich to pay for her tuition at Night City University. It doesn't take much to make her talk. Any character who succeeds at a DV 13 Persuasion Check or a DV 10 Interrogation Check can get the following information.

- The High Class Heist Crew are a bunch of college students who fence stolen items at Night Markets to pay for college. They aren't hardened criminals and they don't even carry weapons.
- Kevin stole an agent from Kodai on the night Ai was kidnapped but he didn't see a woman with Kodai. Jane didn't see Ai either.
- Kevin told Jane that there was some majorly valuable stuff on Kodai's phone, but he didn't elaborate. He just said it was gonna make them rich and set them all up for life.
- Kevin and some Techs in the gang are back at an old server farm they run, extracting the data on the phone or something. Jane doesn't really know what they're doing but she can give the Crew the address of the building in the university district.

Allow the Crew to continue investigating. If they choose to go to the building in the University District, **GO TO CLIMAX (TOGETHER FOREVER)**.

## **PDEV (DEAD ENDS)**

If the Crew attempts to cross reference the older image of Ai on the Data Pool, they can make a DV 24 Library Search Check. If they succeed, they find that image in one other place: an obituary from about a decade ago. Ai's body was found in a dump site in the Hot Zone. Her cerebral systems and her neuralware were burned out and it was ruled a homicide by cyberattack. The case eventually went cold when they couldn't track down the culprit. Should the Crew think to contact 4overTechnologies to check on Ai's status, the corp will tell them that Aisha Tiang hasn't worked for 4overTechnologies for 12 years.

Allow the Crew to continue investigating or **GO TO CLIFF (HEADBREAK TONIGHT)**.

## **PCLIFF (BREAKING IN)**

The Crew may want to investigate Kodai's apartment further or, if they seem stuck, Rogue will call their leader and suggest the Crew heads back to Kodai's apartment to get more information. She's heard from a contact that he's not home and they might be able to find something interesting.

When the Crew arrives at Kodai's apartment, they find it locked. With a DV 15 Electronic/Security Tech or Pick Lock Check the Crew can break in.

Kodai has already marked the Crew as "welcome" in his apartment so the security system will only alert the guards if they acts furtively or do anything obviously illegal. If the Crew plans to do a bit of B&E, they should swagger in like they own the place.

If the Crew does do something illegal or questionable, like stealing items, breaking things, or ransacking the apartment, the security system will silently activate the Ground Drone which rolls out from the wall in the hallway and attacks any characters in the apartment.

A Netrunner can find an access point to the apartment's NET Architecture in the Corridor.

As the Crew noticed during their first visit, Kodai Khan lives in a very nice, up-scale apartment with all the luxuries expected of a decently wealthy corp. If they take some time to investigate, they can find a few key things in the apartment.

## **CAMERA RECORDS**

If a Netrunner manages to hack into the Camera Records of the conapt they can scroll through the last week in the Conapt. Once they get past the last few days of Kodai sulking and pacing, they come to the day of the kidnapping. The recordings of the few days before that fateful night show Kodai living a peaceful, happy life in his apartment... entirely alone. Much like the video recordings from La Lune Bleue, Kodai acts like he's living with another person, even going so far as to pantomime cuddling in bed with Ai and set out meals for her which he later packages up and puts in the fridge.

# AGENTS OF DESIRE

## THE MASTER BEDROOM

In the master bedroom, the Crew finds some signs of Ai: clothing in the dresser, some jewelry, and few small personal belongings. However, with a DV 13 Perception Check, the Crew notices that all of these items are covered in a light coating of dust as though they haven't been touched quite some time. A DV 13 Wardrobe and Style Check reveals them to be at least a decade out of fashion.

On the bedstand, the Crew also finds a framed holo of Kodai and Ai from several years ago. In the drawer of the nightstand, the Crew finds two old security badges; one for Kodai, one for Ai. Both are from Arasaka's Psycho-Cybernetics Research Division which closed its North American Office 22 years ago.

## THE KITCHEN

In the kitchen, the Crew finds evidence of Kodai eating meals with Ai. There are receipts from local eateries, place settings for two, and enough dishes for two people.

If the Crew opens the fridge, they find a well-stocked refrigerator with a whole shelf of plastic containers marked "Ai's Leftovers—Do not Touch." Some of those containers have probably been in the refrigerator for weeks.

## THE BATHROOMS

In both bathrooms, the Crew finds evidence of Ai and Kodai. Toothbrushes, shampoo, make up, and feminine hygiene products. But on closer inspection, one of the toothbrushes has never been used, the bottle of Fragrant Essence shampoo has never been opened and neither have the makeup or hygiene products.

## THE OFFICE

In the office, the Crew finds Kodai's work computer, surrounded by pictures of Ai taken at various fancy locales around Night City. In all of them she's smiling, winking, laughing, or making faces at Kodai, who's obviously taking the picture. If the Crew accesses Kodai's computer with a DV 13 Electronics/Security



### Lower Floor

1. Foyer
2. Closet
3. Utility Room
4. Living Room
5. Kitchen
6. Conservatory
7. Balcony
8. Dining Room

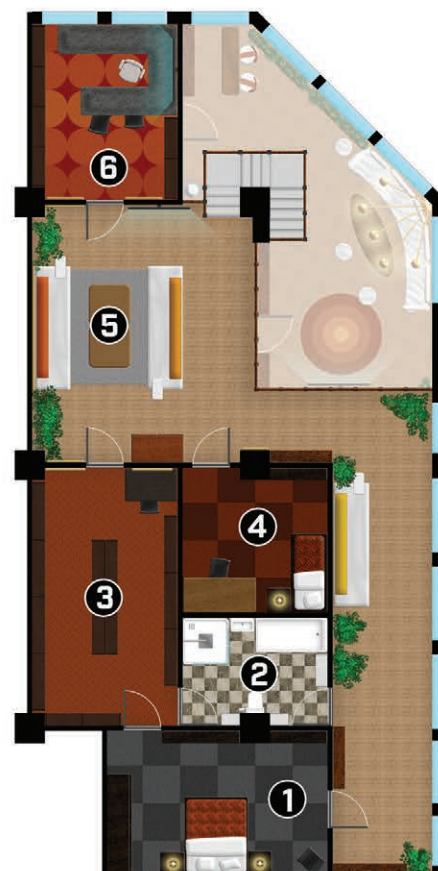

### Upper Floor

1. Master Bedroom
2. Bathroom
3. Library
4. Guest Bedroom
5. Lounge
6. Office

Lower Floor

Upper Floor

BY NIELS E. WISTH



convince him to talk to them through the screen on the door panel. The screen lights up, and shows Lotus LeMarch, sitting at a worktable, tinkering with a cyberhand and not really looking at the screen.

## GO TO OPDEV (THE RICH ARE DIFFERENT)

### OPDEV (THE RICH ARE DIFFERENT)

Lotus LeMarch is a guarded man with a great deal of pride in his work. He gives short, clipped answers while aiming to never give away more information than he needs to and never making eye contact. He becomes visibly irritated if the Crew refers to him as or compare him to a street tech, and emphatically tells them that he is no common "Tech." He is an Elite Technologist who has worked with the most powerful corporations in Night City. With a DV 17 Persuasion Check or a DV 15 Conversation Check, the Crew can convince Lotus to spill what he knows of Kodai and Ai's relationship and her disappearance. If the Crew is able to mention Ai's obituary, no Check is needed to get him to talk. He sighs heavily and puts down the cyberhand, looking up at the screen for the first time.

*"I did work with Kodai Khan but not of my own free will. The man is insane. He... well, he blackmailed me. Threatened to ruin me if I didn't help him make sure his fiancée never left him. We all have secrets we'd rather not see fall into the wrong hands and I didn't think he was as far gone as he was... He brought his fiancée to my workshop, drugged up and barely conscious, although he tried to convince me she was dying. He told me to strap her down and jack her into my Architecture. I thought he... I don't really know what I thought... He had me run a program in my NET: Soullkiller. You have to understand! I didn't have a choice. No one wakes up in the morning and decides to kill some woman and cram her consciousness into an AI. But. But that's what he made me do. I rewired his agent and loaded her engram onto it. Augmented his optics and his cyberaudio so he could see and hear a manifestation of her Engram. He said it was only until he was going out himself. He said he'd come back to have me run Soullkiller on him. So they could be together forever in the NET."*

LeMarch grimaces and nervously picks at a wire on the cyberhand "But that was many years ago. He's contacted me since then. For technical work. Upgrading

*his Agent and such. He seems to think... He seems to think Ai is still alive. It's like he's totally forgotten what he did."*

Lotus LeMarch is haunted by what he did, but he's justified his actions by insisting that he had no choice. As an Ex-Arasaka tech he has a lot of enemies that would love to find him, and Kodai threatened to give his location to all of them. He destroyed the copy of Soullkiller Kodai brought him shortly after using it and has largely been trying to forget what he did. He isn't willing to turn himself in to law enforcement but will help the Crew find Ai by tracking Kodai's agent. After a few minutes, LeMarch tracks the agent to a building in the University District.

At this point, the Crew has a choice: turn the Client in for effectively murdering his girlfriend, or let him continue on in his psychotic conviction that she is still alive and with him. If they contact Rogue about the conundrum she advises them to find out where Ai actually is, if only to turn the Agent over to the NCPD or to Kodai (up to them). But she does point out that Kodai's money still spends even if he is a psychotic killer.

Allow the Crew to keep investigating. If the Crew decides to visit the address in the University District, **GO TO CLIMAX (TOGETHER FOREVER).**

### CLIFF (HEADBREAK TONIGHT)

After realizing what he'd gotten his hands on, Kevin Dickens went behind the rest of the High Class Heist Crew's back and hired another gang (the Saturday Night Buttckickers) to act as protection and muscle just in case Kodai hired people to find him. Feeling braver with some hired muscle, Kevin decided to track down Kodai Khan's conapt via his agent and send the Saturday Night Buttckickers to go see what they can loot out of the place. If the Crew has encountered members of the High Class Heist Crew before, then the Saturday Night Buttckickers have a secondary objective: teach the Crew a lesson.

If the Crew visits Kodai's conapt a second time, the Saturday Night Buttckickers (a number equal to the Crew. Use **Boosterganger, PAGE 172**) burst in and attack anyone inside. If the Crew don't think to visit Kodai's conapt again, he calls them, frantic, noting his place was broken into and ransacked.

He begs them to come over. The Buttkickers will be waiting nearby and attack them on the street.

## GO TO DEV (BUTTKICKER INFORMATION)

### DEV (BUTTKICKER INFORMATION)

If the Crew manages to capture one of the Buttkickers alive, they can interrogate them after the battle. With a DV 15 Interrogation Check or a DV 17 Persuasion Check, the Crew can learn the location of a building in the University District where the Saturday Night Buttkickers were hired to guard some Techs and Netrunners.

The Saturday Night Buttkickers are just muscle though, so they don't know what the High Class Heist Crew are doing.

If none of the Buttkickers survived (or were captured) the Crew will find a Disposable Cellphone on the ground, dropped by one of the attackers. On it are two addresses, Kodai's and a location in the University District. There are also photos of at least one member of the Crew, dressed as they were when they visited La Lune Bleue.

Assuming the Crew investigates the address in the University District, **GO TO CLIMAX (TOGETHER FOREVER)**.

If the Crew decides, instead, to turn this whole mess over to the authorities, **GO TO RESOLUTION (TIL DEATH DO US PART)**.

If the Crew doesn't turn the mess over to the authorities and confronts Kodai, **GO TO RESOLUTION (THE BROKEN MASQUERADE)**.

### CLIMAX (TOGETHER FOREVER)

With the help of either Lotus LeMarch, Jane Gatsby, or the Saturday Night Buttkickers, the Crew tracks down the kidnappers to their hideout (an abandoned server farm in the University District).

The building is old and more than a little damaged, but there don't appear to be any defenses. The windows are boarded up but the door is intact. If the Crew hasn't encountered the Saturday Night Buttkickers yet, then a group of them equal to the Crew (use **Boosterganger, PAGE 172**) are lounging around outside the building. They're trying to look casual, but it's fairly obvious they're there for a reason. If the

Crew approaches, the Boosters give a half-hearted attempt to warn the Crew away from "their turf" before attacking.

When the Crew is able to investigate the building without being attacked by gangers they find that the door can be opened with a DV 13 Athletics or Pick Lock Check. Not being hardened criminals, the High Class Heist Crew abandoned the server farm as soon as they learned that their hired muscle had been beaten. When the Crew enters the server farm, they are overwhelmed by a cacophony of noise. They find all the servers are linked to Kodai's stolen Agent, copying data onto a whole room full of other stolen Agents. The cacophony of noise encompassing the Crew is the sound of hundreds of copies of Ai desperately pleading for the Crew to set them free.

If the Crew decides to turn this whole mess over to the authorities, **GO TO RESOLUTION (TIL DEATH DO US PART)**.

If the Crew decides to ignore the moral implications and finish the job they were hired for, **GO TO RESOLUTION (THE CHARADE CONTINUES)**.

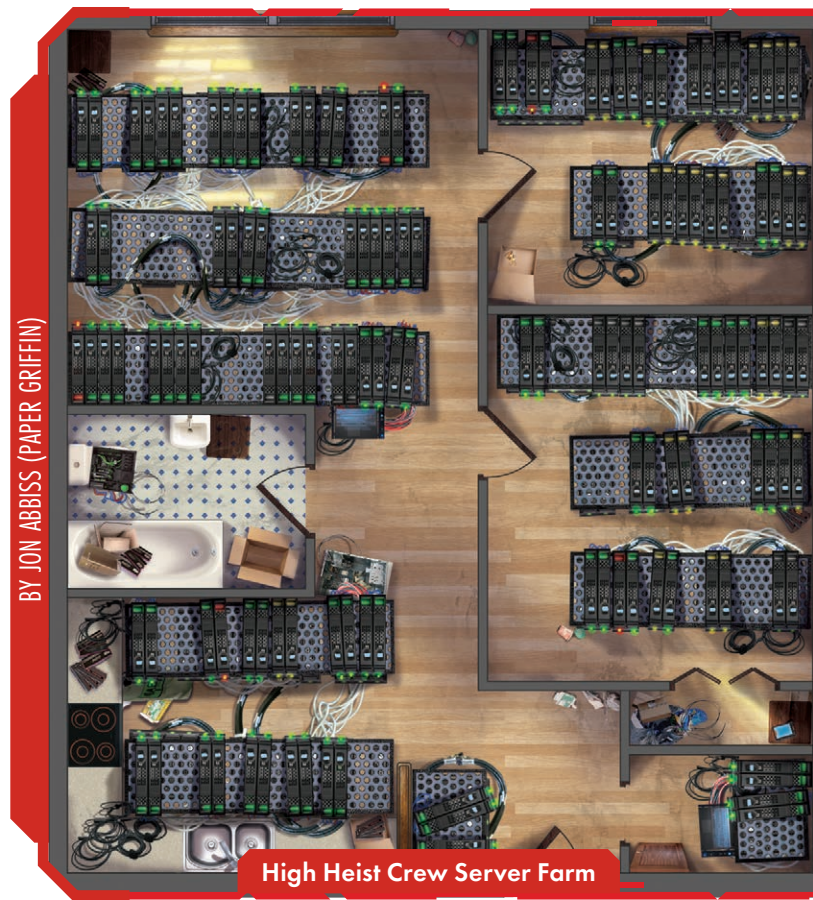

BY JON ABBISS (PAPER GRIFFIN)

High Heist Crew Server Farm

# AGENTS OF DESIRE

If the Crew doesn't turn the mess over to the authorities and confronts Kodai, **GO TO RESOLUTION (THE BROKEN MASQUERADE)**.

## RESOLUTION (TIL DEATH DO US PART)

If the Crew alerts the NCPD to this whole fiasco they immediately get Netwatch involved. This is way beyond the pay grade of a beat cop. MAX-TAC is sent to bring Kodai Khan in for questioning, but the Crew later learns that he refused to go quietly, having a full psychotic break and forcing the psycho squad to bring him down. The hundreds of Engrams of Ai are confiscated by Netwatch and the server farm is dismantled and shipped off. If the Crew turned Lotus LeMarch in to the authorities, he is also taken by Netwatch and never heard from again. If they purposefully left Lotus LeMarch out of the story, he manages to remain under the radar until a few weeks later when he sends the Crew a message.



BY DANI HARTTEL

*"I'm very grateful for your silence. Keep this number. Only use it if you have business."*

With no payment from Kodai, neither Rogue nor the Crew sees any money from this job. Rogue is a bit disappointed, but she concludes the contract and tells the Crew she'll hit them up if anything else comes up that she thinks is their speed.

## RESOLUTION (THE CHARADE CONTINUES)

If the Crew doesn't alert the NCPD and just bring Kodai's agent back to him, he is overjoyed. As they arrive at Kodai's conapt he bursts into tears, rushing forward to embrace the ghost of a woman only he can see. He takes the agent as an afterthought and thanks the Crew for bringing his Ai back to him. He pays the Crew what he owes them and tells them he'll put in a good word with Rogue.

As the Crew leaves the conapt, they hear the one-sided conversation as Kodai starts excitedly talking with Ai, so grateful to have her back. He tells her he'll order in from her favorite place tonight and he'll try to take the day off tomorrow so they can go out to McCartney Field Stadium to watch the Night City Heat.

Rogue contacts the Crew and tells them she's impressed. They really rolled with the punches and got shit done. She concludes the contract and tells the Crew she'll hit them up if anything else comes up that she thinks is their speed.

## RESOLUTION (THE BROKEN MASQUERADE)

If the Crew doesn't alert the NCPD but confront Kodai rather than bringing the Agent back to him, the Crew has a chance to help him come to terms with what he did. They must make sure the Agent is either not on their person or is off when they approach Kodai, or Ai will manifest in his vision and there is no chance of helping him.

A Medtech can make a DV 17 Medical Tech Check, or any player can make a DV 29 Persuasion Check, to try and break through Kodai's psychosis. If they fail, Kodai's mental barriers remain strong and he becomes agitated, demanding that the Crew take him to Ai.

If the Crew refuses, he ultimately becomes violent. If the Crew insists that Ai is dead and they found her body, Kodai spirals into a deep depression. He pays the player what he owes them and tells them to get out. Later that week, the Crew learns that Kodai Khan's body was found in a dump zone in the Hot Zone. The same one where Ai's body was found years ago.

If the Crew succeeds at their Medical Tech or Persuasion Check, they are able to break through Kodai's mental block just enough to help him realize that Ai is dead. He isn't "fixed" by any means, but he has had a momentary breakthrough and recognizes that he has a problem. If there is a Medtech on the Crew Kodai will ask for their help, offering to pay for their services. If not, the Crew can convince Kodai to see a therapist without a Skill Check. He pays them what he owes them and lets them go on their way. He turns himself in to NCPD days later.

Rogue contacts the Crew and tells them she's impressed. They really rolled with the punches and did the right thing. She concludes the contract and tells the Crew she'll hit them up if anything else comes up that she thinks is their speed.

## WHAT HAPPENS TO AI?

No matter what the Edgerunners do the question of what happens to Ai and the duplicates made by the High Class Heist Crew remains important. If the Crew turned Kodai into NCPD, Netwatch takes control of the situation and confiscates the Agent containing Ai as well as the servers housing her duplicates. What happens to them next is a mystery and Netwatch isn't interested in sharing.

If the Crew refused to hand over Ai to Kodai but also didn't involve the authorities, she and the duplicates vanish. One of the Edgerunners receives a single message on their Agent from an unknown source reading, "Don't worry. We'll take care of them on the other side."

If the Crew did give Kodai the Agent containing Ai, what happens to her is unknown but the duplicates do still vanish and one of the Edgerunners receives the above message.

What the message means for Ai, the duplicates, and the Crew's future? We leave that up to the Gamemaster.

## NET ARCHITECTURES

### ▶ LA LUNE BLEUE

**Demon Installed: Imp**

**REZ 15 • Interface 3 • NET Actions 2**

**Combat Number 14**

Can perform any NET Action a Netrunner is capable of.

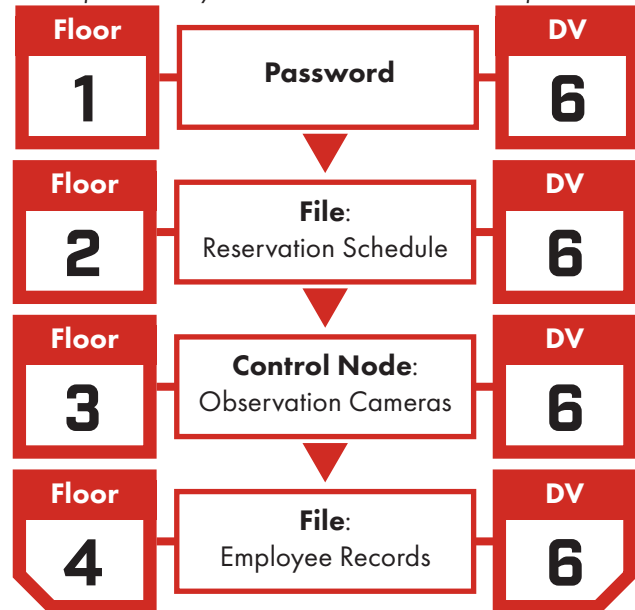

### ▶ KODAI KHAN'S CONAPT

**Demon Installed: Imp**

**REZ 15 • Interface 3 • NET Actions 2**

**Combat Number 14**

Can perform any NET Action a Netrunner is capable of.

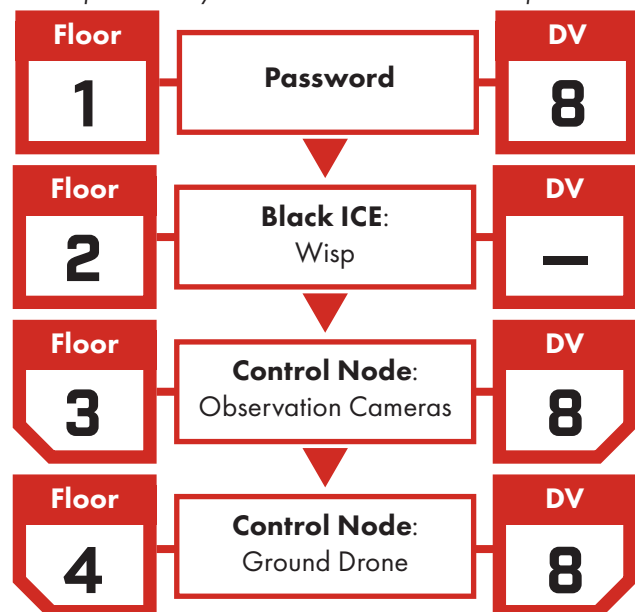

# AGENTS OF DESIRE

## NPC STAT BLOCKS

For more information on important NPCs **SEE APPENDIX B: BIOGRAPHIES.**

SEE PAGE 187 FOR BIOGRAPHY

<b>NAME</b> KODAI KHAN (REP 2)	<b>SERIOUSLY WOUNDED</b> 18	<b>HP</b> 35
<b>ROLE</b> EXEC: TEAMWORK 2	<b>DEATH SAVE</b> 4	

**STATS**

INT 8 REF 7 DEX 3 TECH 7 COOL 7 WILL 5 MOVE 7 BODY 4 EMP -4

<b>WEAPONS</b>			<b>ARMOR</b>	
POPUK HEAVY PISTOL	ROF2	3d6	SKIN WEAVE (HEAD)	SP 7
NONE	—	—	SKIN WEAVE (BODY)	SP 7

**SKILL BASES**

Accounting 14 • Athletics 10 • Brawling 9 • Bureaucracy 13 • Business 14 • Concentration 8 • Conversation 0 • Deduction 10 • Education 14 • Evasion 10 • First Aid 8 • Handgun 10 • Human Perception 2 • Language (English) 14 • Language (Streetslang) 12 • Lip Reading 15 • Local Expert (Upper Marina) 10 • Perception 18 • Personal Grooming 13 • Persuasion 12 • Stealth 11

**GEAR**

Heavy Pistol Ammo x32 • Agent • Another Agent • Businesswear Mirrorshades

**CYBERWARE**

Audiovox • Biomonitor • Cyberarm w/ Popuk Heavy Pistol, Realskinn™ Covering • Cyberaudio Suite w/ Amplified Hearing, Audio Recorder, Bug Detector • Cybereyes x2 w/ Chyron, Image Enhance, MicroVideo • Enhanced Antibodies Neural Link w/ Chipware Socket, Interface Plugs • Skin Weave • Techhair • Toxin Binders

SEE PAGE 186 FOR BIOGRAPHY

<b>NAME</b> JANE GATSBY (REP 1)	<b>SERIOUSLY WOUNDED</b> 20	<b>HP</b> 40
<b>ROLE</b> FIXER: OPERATOR 2	<b>DEATH SAVE</b> 6	

**STATS**

INT 6 REF 6 DEX 7 TECH 4 COOL 7 WILL 6 MOVE 7 BODY 6 EMP 6

<b>WEAPONS</b>			<b>ARMOR</b>	
HEAVY PISTOL	ROF2	3d6	NONE	—
NONE	—	—	NONE	—

**SKILL BASES**

Athletics 13 • Brawling 11 • Bribery 10 • Business 8 • Concentration 10 • Conversation 11 • Education 11 • Evasion 13 • First Aid 7 • Forgery 9 • Handgun 11 • Human Perception 12 • Language (English) 14 • Language (Street Slang) 14 • Local Expert (University District) 14 • Perception 11 • Persuasion 10 • Pick Lock 11 • Stealth 14 • Streetwise 13 • Trading 13

**GEAR**

Heavy Pistol Ammo x16 • Bug Detector • Disposable Cellphone x3 • La Lune Bleue Waitress Uniform • Memory Chips w/ episodes of an old animated TV show x3 • Stolen Agent x2 • Stolen Businesswear Jewelry x3

**CYBERWARE**

Cyberaudio Suite w/ Audio Recorder, Internal Agent, Voice Stress Analyzer • Subdermal Pocket



# POPCORN-FLAVORED KIBBLE

## BACKGROUND (READ ALOUD)

Lights, camera, action! It has been the dream of many a starlet to show up on the silver screen — especially now when the action can be shown off in stunning 3-D with sense-simulation streams. Now your Crew can get in on some of that sweet Addiswood action after your Fixer scored an audition invite for the famous Senait Sisters' upcoming historical romance, *The Parisian Hostess*. It's legit, the leading and supporting actors have already been cast, and you all have a chance of making it as extras — which is definitely going to be a step up in the career of any budding media star!

And even if you aren't interested in a career in the light of the hologram projector, there's the pay, the access to Catering where you can score a meal that isn't kibble, and the potential for side gigs and lucrative connections. What's to dislike about this gig? Nothing at all! But you know that meme about something seeming too good to be true? Yeah, well that shit goes double in Night City, choomba

## THE REST OF THE STORY

Teresa and Fanta Senait are genre-busting Addiswood directors with sixteen blockbuster flicks to their credit. They co-produce and direct all of their movies with exacting care, preferring to shoot on location with local talent instead of isolating cast and crew on an Ethiopian soundstage. The Addiswood entertainment industry has Eurobucks to throw around—all that Highrider traffic and trade means a population of workers who have the cash to fling at entertainment. Not to mention Orbital Air can get them anywhere they need to go!

This means that the Senait Sisters have effectively flown into Night City with the equivalent of an AV full of cold hard currency, and are right now injecting it into the local economy as they cast extras and set up to shoot on location. They've brought the cast and crew with them in immense converted cargo vehicles—AVs, planes, trailers, via a brokered deal with several of Night City's Nomad families, all of whom are currently buzzing about recruiting any and all family members they can to assist with this massive logistical operation, because even a fractional percentage of the Senait Sisters' budget is nothing to sneeze at.

Your group of Edgerunners is among the denizens of Night City elbowing in to get a chance at that sweet, sweet vid-sim money — because you have to pay rent and buy kibble and afford medical treatment, and even if you're flush right now, more eddies are always nice, right? Fortunately for you, the Senait Sisters really do believe in hiring extras and minor cast members locally, and you all have an invite to an audition!

Unfortunately for you, the rest of Night City also really wants set access and the plush side benefits that would come with a job, so the first step to making the audition date is... making it to the audition itself.

## THE SETTING

After an opening in the Upper Marina, the Crew might find themselves traveling to Heywood and the University District, but most of the adventure will take place in and around various locations just across the southern bridge and below the central part of Night City. This zone is Rancho Coronado, and in better days, it was largely a mix of corporate suburban housing with industrial zones. This all changed after the War and the exodus of people from the heart of Night City that flowed into most every adjacent region. Being hit harder by this than many of the nearby zones, most of the neighborhoods are now crammed with refugee camps and tent cities filling every possible space they aren't bodily ejected from!

## THE OPPOSITION

As scarcity is, unfortunately, a condition of Night City life, there are others who want things the Crew have access to. Their opponents might include:

- **Fellow Would-Be Extras**, made up of other Edgerunners who failed to score an audition invite and hope to acquire one from the Crew.
- **Markus "Malarkey" Bornholm and his Security Escort**. Malarkey is a local Night City "journalist" of the most trashy tabloid sort. Sensation, sleaze, and almost-libel are his best friends, as he follows people around recording their worst behavior in order to manufacture a viral trend. Malarkey makes enough off his sensationalist vidjournalism that he can afford a crew of muscle to keep him

largely unbruised during his missions to expose others to the searing eye of the Night City Data Pool. He's been putting on the paparazzi act ever since actor Etan Sim got caught erotically entangled with a co-star sixteen months ago, and most Night City gossips have been lapping up the scandal straight from Malarkey's feed.

- **Darrel Marchant**, actor Etan Sim's ex-husband, formidable Solo specializing in personal protection. He's not likely to fire at the Crew unless they really, really blow their approach to him. But he will shoot to kill if he spots Malarkey. So how entertaining would it be to everyone involved if Malarkey, though trusting his bodyguards to be able to protect him, is indeed out to goad Marchant into firing shots at him just to trash his reputation?

SEE PAGE 50 FOR STAT BLOCKS

## THE HOOK

*You've all been invited to an anonymous-looking warehouse in the Upper Marina. It's not a bad neighborhood, not really, and people are more likely to go past with a tool belt on than a holstered Heavy Pistol. Your invitation and bona fides consist of a calling card with a small chip built into it. The plastic is dull, gray, but fresh and new without the many scratches a keycard would have acquired over repeated use, and there's a number written on it in permanent marker, 27. Maybe that's going to be your lucky number.*

*But first, things first, how did you glam yourselves up for the audition?*

The story begins with a friendly Fixer or other well-connected contact setting the Crew up with an audition as extras for a genuine Addiswood film! Addis Ababa (hence the term "Addiswood") is one of the entertainment centers of Africa and movies made there are a major export to the Highrider Confederacy. Their point of contact stresses the film's directors, the Senait Sisters, are searching for genuine Night City flavor.

Just what "genuine Night City flavor" means is up to the Crew but give them a chance to shop for new clothes, update their Fashionware, and generally spiff up their appearance. This is a great time to call for Personal Grooming and Wardrobe & Style Checks.

When they're ready, **GO TO CLIFF (RIVAL CREW)**.

## CLIFF (RIVAL CREW)

The toughs hanging around outside the warehouse are a low-rent Edgerunner group led by a newbie named Rustle. They've heard about the Senait Sisters' shoot, but lack the Nomad family ties or the Fixer access to receive an audition invite. So they're going to do what enterprising Night City Edgerunners frequently do: They're going to case a group of invitees, and take their audition keycard away from them. One group of scruffy-looking Edgerunners is pretty much identical in composition to another, right?

The rival team is made up of as many novice Edgerunners as there are Edgerunners in the Crew (For Rustle, use **Security Operative**, PAGE 173; For everyone else, use a combination of **Bodyguards** and **Boostergangers**, PAGE 172). Rustle does not resort to attacking the Crew immediately. He simply fires a warning shot at their feet and tells them he would love it if they put the keycard down and backed the heck away. With his friends backing him up from nearby alleyway approaches and behind dumpsters, it's quite easy to see that he's set up a pretty good ambush.

The GM is not encouraged to just spring Rustle's team upon the Crew. Any sharp group of Edgerunners would be able to spot the signs of an ambush with a DV 13 Perception Check. They have several options open to them to deal with Rustle's ill-advised ambush. They can set up their own counter-ambush, baiting Rustle out into the open before ventilating him with their own weaponry. They can simply evade his ambush by taking an alternate route to the warehouse (DV 13 Local Expert [Upper Marina] Check). They can intimidate him into abandoning his plan (DV 13 Persuasion Check) or bribe him into going away (DV 13 Bribery Check). This situation can also be resolved with a successful Facedown Test (SEE CP:R PAGE 194), which will back the rival crew down and send them slinking off into the night.

If things all go pear-shaped, it should be made clear that Rustle and his team won't fight to the death. The first two serious hits on any of his people will convince them to break off and retreat.

Once Rustle and his crew have been dealt with either via violence or street smarts, the Crew gains access to the warehouse and its interior.

**GO TO DEV (AUDITION)**

# POPCORN-FLAVORED KIBBLE

## DEV (AUDITION)

The Crew is greeted by the Senait Sisters' Night City location security staff, who funnel them behind the locked, armored door to the audition suite. There is a row of plastic desks and some austere chairs there, enough to seat eight people comfortably, facing a large screen and several cameras of the kind used in teleconference calls. The Senait Sisters are not there in person.

The Edgerunners are asked to take a seat and provided water or the non-alcoholic beverage of their choice, and then the lights on the cameras begin to glow red as they go live.

The projector blinks on, and the Crew is greeted by an image of the Senait Sisters from an as-yet-un-disclosed location. They are seated comfortably on armchairs, and smile cordially, one after the other, as the Edgerunners' images are projected onto a screen on their end. Teresa, the older sister, speaks first, her voice velvety and deep. She is wearing a traditional dress of hand-woven cotton, and a gauzy shawl wrapped around her back and shoulders, one of the edges tucked over her head like a hood. "I apologize for the runaround," she says, "but hiring from the local

population like we do, sometimes too many people can arrive at the same time. So we try to split our auditions up between multiple sites to prevent a stampede."

Fanta, the younger Senait sister, wears a very stylish pantsuit in Western-style, with silver lost-wax cast bracelets on each wrist. "They look promising," she says, glancing over at Teresa.

The Crew may note that the Senait Sisters are choosing to check each batch of extras out on their own despite the lack of physical access. They're certainly not palming their work off on personal assistants and second unit directors, nor on casting agencies. Nope. They pay the Crew the attention that they're famous for devoting to every aspect of their film work.

The Edgerunners are invited to stand up and turn around, one by one, but as extras don't generally have extensive speaking roles there are no script reads.

The screen goes briefly blank thereafter as the Senait Sisters discuss amongst themselves, and then blinks on three or four minutes later.

"We are pleased," Fanta says, "to offer you roles as extras in our current shoot. The crowd scene we think you will fit best in will be shot at the Highcourt Plaza Hotel. We are renting the entire place out for that week of shooting, so we will need to provide our own street color, which is where you come in."

"If you consent, our extra rate is 200 Eurodollars a day, and we will likely need you for two days. If that is amenable, one of our security staff will pass you the contracts, and direct you to the next room where several of our costume stitchers will measure you for costumes."

Once they've finished their paperwork, the Crew is indeed directed to the next room where they are measured for costumes. As extras, they don't rate custom-made duds, but being a period piece, most of the clothing they're wearing doesn't quite work for the look the Senait Sisters have in mind. One of the costume technicians, Lazar, waves them one by one to a laser measuring booth, where their physical measurements are taken with a quick scan, and then logged for reference.

After they're done, Lazar notes the Crew seems capable and shares some information.



BY JEFFREY McDONALD

# POPCORN-FLAVORED KIBBLE

"I hear Catering is having some trouble over in Rancho Coronado—that's where we've set up. Very hush-hush, so don't blab this around, but if you want to make a bit of side money I'm sure they'd appreciate some local assistance. Maybe they'll even upgrade you to the nicer catering tables that we keep for the main cast, if you help. Here, let me set up an appointment."

Lazar whips out an Agent and, after a series of exchanged messages, informs the Crew that they're to go straight to the location and ask to speak to Cookie.

## GO TO DEV (SPOILER SCRIPTS)

### DEV (SPOILER SCRIPTS)

On the way out of the audition location, the Edgerunners are accosted by a clutch of teen and tweenage youths all dressed in cosplay costumes of characters from Etan Sim's prior videography.

"Hey, hey!" the loudest and most persistent kid says, waving a wad of Eurobucks in the Crew's faces. This is still a slightly rough neighborhood and waving cash like this can get the youths mugged, so benevolent-minded Edgerunners may want to warn them about it. The Crew, if curious, may also wish to hear them out, at which point they decamp to a nearby parked food truck to talk.

If so, this is what the loudest of the group, an androgynous teenager named Ashley, says:

"We're the Simwives, the biggest Etan Sim fan club in Night City, because we all want to be his waifu. The Senait Sisters are notorious for anti-spoiler efforts — they only have hardcopy scripts printed on dark red flimsies so nobody can scan them optically and put the text online, and stuff like that. But we want to be able to say sweet Etan's lines along with him when the movie comes out...so we've decided to put all our savings together and ask if you're willing to get hold of a script."

Their savings comes up to a respectable 376 Eurobucks, not bad for an unofficial Etan Sim fan club. It is up to the Crew whether they want to actually work for the kind of people who will probably post spoilers and talk aloud in the theater. There's a special place for people like that, some believe.

"Pay on delivery," Ashley says, "And no fake scripts, Will's dad works for Ziggurat and knows what they're supposed to look like. The Senait Sisters scripts will be serial-numbered so they can trace leaks."

Ashley gives the Crew a contact number so they can call the fan club if they happen to procure a script. Once they've dealt with the fan club, the Crew should make their way to Rancho Coronado.

## GO TO CLIFF (ORGANIC DIET)

### CLIFF (ORGANIC DIET)

Catering is working out of a few fancy food trucks rented from the Aldecaldos Nomad family. The location is privileged and kept very discreet because there is filming going on right now. After the Crew establishes their bona fides via Agent, they are allowed into Catering, which is a buzzing hive of activity. Trays of snacks are being prepped and put out for the actors involved in this specific shoot. Finding Cookie isn't hard. The Crew just needs to locate the most harassed-seeming individual around. Once they introduce themselves, Cookie explains the problem to the Crew.



# POPCORN-FLAVORED KIBBLE

## THE DIRTY HIPPIES

Though frequently mistaken for a gang, the Dirty Hippies are a group of urban Reclaimers and who help clean up blighted zones by using eco-friendly technologies. They're also famous for their ganga.

## THE GROCERY RUN

Beyond the Dirty Hippies, clever Edgerunners can figure out a few other spots capable of delivering the organic, fresh foods needed. Feel free to invent more!

### Nana Meow's Nursery:

A family-run business in lower Heywood that sells aquaponic equipment and seeds. Complication: Gramma needs help cleaning out a grow room!

### Stems & Seeds:

A guerrilla gardening collective found near NCU. Complication: Lily, the lead gardener, wants Mael's autograph.

### Jack 'N' the Green:

A Reclaimer company located in Rancho Coronado. Cheech, aka The Wizard, runs this group. Complication: They will want a favor later.

### Vargtimmen:

Neo-pagan "meadery". Wily proprietor Freki owns this faux Viking hall in Watson. Complication: They want a deal to sell their "mead" on the lot.

*"Yeah, Lazar told you about our trouble. He didn't specify, did he? Our leading lady, Mael Cartaret, has a very specific diet she's supposed to follow to maintain her good looks. She specifically won't eat anything that isn't "real", or organic. Organic food. No synthetic fertilizers, no artificial amendments to the soil, etc. I've tried to tell her personal assistant that we're not sending a Nomad AV to fly over to Lyon just to get her a cucumber and a wedge of cashew cheese from her favorite grocery store. I'm not a local, so I don't have the contacts or the knowledge to find a good source of food that, frankly, isn't kibble. Oh no. Here comes Mael's personal assistant again... look, come on over, and we'll talk. There's cash in this for you if you help me solve this."*

Anyone keeping an eye out for stars will be treated to the sight of leading man Etan Sim in an artfully distressed costume, fake bullet holes in his prosthetic makeup, staggering in to ask politely for a frozen kibble smoothie bowl, which has to be made on the spot. He's being squired by a minder and is on the clock, so no autographs, although he'll wave in a friendly manner at the Crew.

*"Bless him," Cookie says, as Etan Sim walks past. "He'll eat anything. Now... Mael's personal assistant has left me with this list of specific things she's currently eating on her cleanse diet. I swear she probably sneaks a bag of bacon cheddar dumpburger kibble every night, since there's no way anyone can live on this little food. But she wants these things and she would like them ready in five hours when shooting ends. You don't have to buy them for me, but I'd love it if you can find local suppliers. I'll work out the orders, and then you get paid. How's about a hundred euros' finder's fee per entry on the list?"*

The list reads thus, in some exaggerated pretty handwriting:

- Vegan juice cleanse smoothies for dinner.
- Berry-yogurt fruit parfaits for breakfast.
- Grilled fish and steamed vegetables for lunch.
- Vegetarian faux-charcuterie and cheese for between-scene snacks.

There is, moreover, a note on the bottom that reads *It has to be all-organic or she won't touch it, thanks!*

That is a tidy 400eb for an afternoon of work, and if the Crew succeeds Cookie will upgrade them to the actor catering list as opposed to the extras catering list, allowing them to partake of some of the fruits of their labor. Now. How are some ambitious Edgerunners to get hold of a list of normally-unattainable delicacies?

This is where Edgerunners with Corporate, Nomad, or guerrilla farmer contacts get to shine. Corporations would definitely have access to some of these pure, organic foods, and would love to be a sponsor. Nomad families simply have access to goods, seeing as they are the heart of Night City logistics and shipping. Then there are the usual suspects in Night City — Night Markets. Some Night Markets have Dirty Hippie representation. Surely they would have a plethora of delicious produce to hook the movie shoot up with, for the right price. Edgerunners may make the appropriate Streetwise, Trading, Persuasion, or Bribery Checks at DV 15 to secure each item on the list.

If a Player comes up with an unorthodox means of acquiring an item, the GM should encourage them to do so, substituting the right Skill Check. If your Crew know an ornery gunsmith with an aquaponics setup who'll trade fish and veg for labor, heck, the Crew Tech may just help the old coot for a shift just to get hooked up.

This task is fairly trivial, all things considered — but it's just a way for the crew of the movie to establish the Crew's competence.

# POPCORN-FLAVORED KIBBLE

Passing this simple task will give them access to more side gigs, which will add up in time. Once they return from their various sources in triumph, Cookie pays them and hooks them up with premium rations, which they are allowed to sample from here on in. This will raise the group's Lifestyle **(SEE CP:R PAGE 377)** to Fresh Food for this month, as far as it relates to food only.

## GO TO DEV (GO SEE BUCK)

### DEV (GO SEE BUCK)

Once the Crew finishes their work for Cookie, she directs them to the Special Effects team, who are working out of a rented warehouse nearby.

*"Practical effects fabrication is handled by a dude named Buck, you'll know him, he's about yay tall" Cookie holds a hand far above her own height, "and he wears a flannel shirt everywhere. Also, he says 'about' like 'aboot'. You can't miss 'im. He and his folks are having a little fun coming up with a puppet Cybersnake for Morgane Sonnentag's Yakuza assassin character and would love some feedback from folks who have been in the thick on the street. You know. Edgerunners." She grins and sends them off with actual Freshpak lunches leftover from the actors' catering tables — real pastrami sandwiches on rye with a cup of bean soup and a small cup of real coffee each.*

## GO TO CLIFF (SNAAAAAAAAKE!)

### PDEV (IF IT BLEEDS IT LEADS)

This Development can occur at any point before Development (Clandestine Meeting) while the Crew's away from the movie lot. As they're going about their business, Edgerunners are politely accosted by a dude shaped like a refrigerator with a head.

*"I represent a journalist who wishes to speak to you."*

He points to a dark, low sedan, and nods encouragingly. The Crew may tell him to eff off, or they may be curious enough to accept the invite. If they do, the sedan rolls up to the curb and the window comes down to reveal Markus "Malarkey" Bornholm, Night City gossip blogger and paparazzo-in-chief.

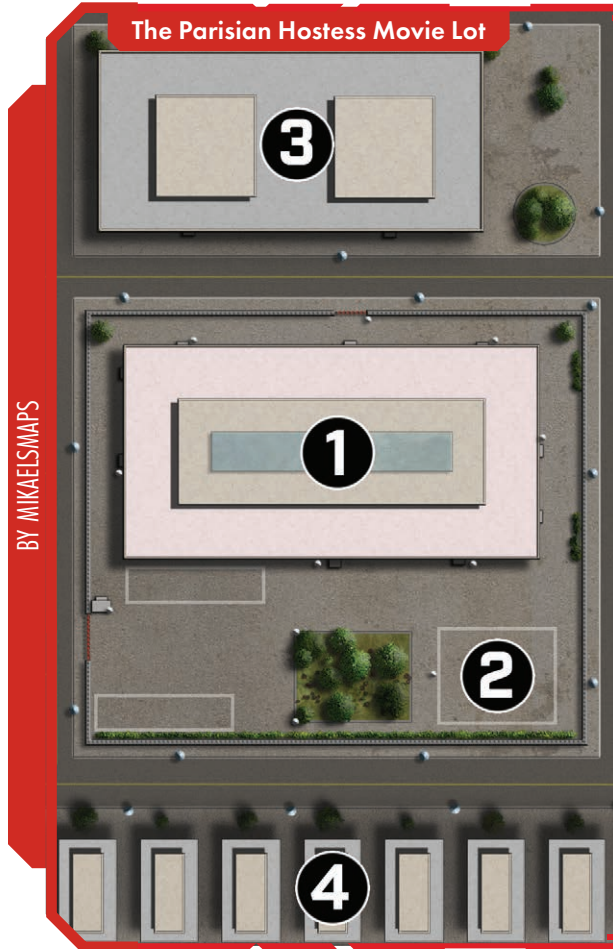

BY MIKAELSMAPS

1. Soundstage
2. Catering Area
3. SFX Warehouse
4. Cast Trailers

*"Hey. I have a job for you, if you're interested." He smirks. "I've got a sweet 500 Eurobucks for you if you do it, and that's probably more than the Senait Sisters are going to pay you for extra work. It's practically free money." His bodyguard offers the Crew a little fingertip-sized plastic nub in a small plastic bag.*

*"That's a low-profile audio bug. Pull out the white tab on the bottom edge for the battery to connect and it'll start recording. I want you to find your way to Etan Sim's trailer and put it there. You have set access now, and they're going to ask you to do a bunch of scut work. Might as well stop by his place on the way, right?"*

If the Crew objects, Malarkey points this out. *"I've approached quite a few extras already. Sure you don't want to beat the others to it?"* He isn't offended if they leave, however.

Malarkey is a thin, almost-skinny dude of middling height, unremarkable except for the lime-green cybereyes he has implanted, and the show-off LEDs that

# POPCORN-FLAVORED KIBBLE

indicate when his camera is live (because he enjoys the way people squirm when they realize he's filming everything he sees.) He is almost always seen wearing a black mock turtleneck and a pair of sturdy chinos but has been known to slap on the Light Armorjack when going into situations where irate subjects may start firing shots at him.

## BUCK (SNAAAAAAAAAAKE!)

Buck is in fact as tall, as flannel-clad, and as Midwestern as Cookie has described. He waves the Crew in.

*"Cookie sent me pictures on her Agent, I know you. You're the folks who helped out at Catering. Come on in. We've got our own little nest here where we make some of the movie magic happen."*

Buck's workshop buzzes a little less than Catering — the pace of work is less frantic, more steady, with caffeinated beverages essentially on tap. The warehouse

has been divided into several workshops and mini-facs in an open plan — there's a welding station, an area where they sculpt clay masters and cast resins for props and prosthetics, soldering stations, various little laptops hooked up to animatronics, which at present they are testing for range of movement and reliability.

*"Teresa and Fanta are great bosses to work with. And they don't go for the salacious pretty much, so this is what we're working on."*

*"This" is a prosthetic cyberarm built to medical specifications, with an impressive facsimile of a cybersnake made in soft silicone foam that shoots out of an orifice in the palm. It looks very much like the real thing, and is temporarily hooked up to a laptop so that Buck and his folks can control it with keystrokes to make it move.*

*"Morgane wasn't so much cast as much as just called by Fanta and asked to play the Yak assassin, they're really professional too, and they've come in to try on the prosthetic several times for fit. It works fine, and they can control both the arm and our fake snake just fine. We're just concerned about verisimilitude. Big word, I know, but the fake snake has to look not fake after effects. I'm just a great big nerd under the flannel, so I have no real experience with ever seeing someone deploy one of these. You're largely here to help us either figure out whether it's working well, or looking like an out-of-control garden hose. Tell you what. You help me fine-tune this thing, and I'll tack on a 250 Euro consultant fee, I've room in the budget for that."*

This is where Edgerunners, who have either used or seen Cybersnakes in combat or are Techs, get to show off their expertise. Lacking those two options, an Edgerunner can also bring in a local contact who either has a Cybersnake or has seen one deployed. Given this type of Cyberware is often used by assassins, covert operatives, and sex workers, there may have to be some serious Persuasion Checks and/or promises made to get someone to come in and reveal such a discreet implant. Buck lets them at the little remote control that is wirelessly hooked up to the prosthetic/prop, and they're allowed to aim it at styrofoam targets and generally make like a wrecking ball and have all the fun in the world.

The appropriate Checks to make here would be Tactics, Brawl, or Cybertech, at DV 17. Buck's folks have made a very good puppet, but it doesn't move



BY SEBASTIAN SZAND

# POPCORN-FLAVORED KIBBLE

quite right, yet. As before, Players with amusing and plausible alternative Skill Check suggestions should be allowed to attempt them — this can be a group effort.

Once they've finished with this particular assignment, **GO TO DEV (CLANDESTINE MEETING).**

## DEV (CLANDESTINE MEETING)

On the way out of the effects warehouse, the Edgerunners are approached by a slender purple-haired man in a nice, boring, gray suit. He is Oliver Riddle, personal assistant to Etan Sim, and he has a tray of synthcoffees balanced on one hand. The drinks are all labeled for various members of the effects crew, his ostensible errand for being in this area.

*"Excuse me," Riddle says, "but Mr. Sim saw you all in the catering area earlier, and he would like to invite you to a private meeting at his trailer tonight at 8 p.m. as shooting ends at sundown today and he'll need a bit of time to get all that gore makeup off. I'll authorize your Agents to gain access to his trailer. If you wish not to meet him, you need only not show up, your authorizations will only be valid between 8 and 8:10pm"*

That said, he smiles, nods, and steps politely away.

Etan Sim's trailer is surprisingly small and pleasantly austere, unadorned with frippery. It has the atmosphere of a working place as opposed to a posh retreat from the world. Say what you will about his personal mishaps, he is known to be a very dedicated actor trained in both the Stanislavski and Adler Methods. A dog-eared copy of the movie script sits on the trailer's sole dining table. His bed is clean but unmade, and there is no trace of his personal assistant, since this is a private meeting. While he has no bodyguards on hand, the actors' trailers are moored in an area crewed by hired security workers, who can be summoned with the press of a panic button.

Sim is his usual handsome self. Well, no. He's a little less tall, a little less angular, much less craggily perfect minus all the editing people do in photos and on film to make his appealing face even more appealing, but he is still quite handsome and charming. He is clad simply in a button-collar Henley shirt and a pair of jeans, and is currently wearing an incongruous pair of fluffy slippers.

*"Hi," he says, a little awkwardly as he greets the Crew at the door, "can I offer you something to drink? I've got some mineral water, sweet stuff out of a carton, tea, coffee. I don't have alcohol around right now, I'm working on breaking the habit."*

Once beverages have been dispensed or refused, he waves them to various chairs he has about the place — there's a small loveseat and an armchair around a coffee table and various kitchen chairs to go with his combination work desk/dining table. If the Crew is a large one there's even seating on his unmade bed. Edgerunners who wish to take Malarkey up on his offer may place the bug now or as they leave with a DV 13 Stealth Check. Etan Sim is preoccupied, and not quite looking around for bugs or attempts to plant them discreetly. The GM should take note of the degree of success which they rolled, as it will be relevant later.

*"I've been going through the things in my rented storage cube — I let Darrel keep the house in the divorce — and I found some things of his mixed in my stuff. I must have grabbed the wrong box on the way out."*

He goes to his closet and pulls a cardboard box out of it, laying it gently on the table. In it, double-bagged and packed in tape and shreds of nestlike padding is



Etan Sim

# POPCORN-FLAVORED KIBBLE

a set of pale-green ash-glazed ceramic plates. They are made with exacting simplicity, with the marks of the potter's hands left behind in the clay. They seem to glow like pearls in the light of the fixture above the dining table.

*"He's got the rest of the set with him, cups, bowls, jugs, salt and pepper shakers — these were made by his mother, who was a ceramicist, she gave them to us when we got married. Died a year later. Massive aneurysm. Anyway. They're the last keepsake he's got from her, and...right now I don't feel worthy of holding on to them, even though they were a gift to us both. I'm trying to be a better man, and I want him to have them back, because Margaret was always very nice to me." It's clear he misses his late mother-in-law, as his eyes are very bright with unshed tears. They are not feigned, despite his reputation for convincing acting skills.*

*"Anyway. I know Darrel's address, since I used to live there, and I'm fairly sure he's at home right now. I can't just call him up to check because he's blocked my Agent, but I'll give you his personal number as long as you promise not to misuse it, please. He's had enough shit from my misbehavior. I want you to arrange a drop-off and deliver the plates to him. I can't do it myself, the gossip rags would be all over it if we met again. I'll pay you. 500 Eurobucks for the delivery, plus 500eb hazard fee in case Darrel is still upset."*

Should the Crew agree with the conditions Etan has set, continue with the mission as follows. If they refuse, then he thanks them for their time and asks them to leave. Edgerunners who wish to accept the Simwives' request may make a Stealth (DV 17) Check to steal the script — while Sim is distracted and not looking out for bugs, he is pretty attentive to the contents of the table, especially because the script is something he's currently revisiting constantly. If they fail greatly and get caught, they may be removed from the set by security. GM discretion should be used in how to handle the possibilities.

Once the Crew's agreement has been secured, Etan gives them two pieces of information. Firstly he gives them Darrel Marchant's number, and asks them to call him from another location since he can't be sure if he's being bugged by Malarkey. Next, he gives them the delivery address, which is a beautiful three-bedroom house in Little Europe. He also provides them with a foam cooler to put the box of plates in, for extra padding.

*"Try to get them there intact. Maybe Darrel will send one of his security crew out to meet you. That's what he'd probably do, knowing him. Tell him — Nevermind. He might not believe you were given his number, so use this password — 'two Tequilas and a pretzel.'"*

The Crew now needs to find the best privacy they can to contact Darrel Marchant in. Fortunately, they know exactly where to go. The effects warehouse workshop in Rancho Coronado has security on all entrances as is standard leak-prevention policy and Buck owes them a small favor if they did help him with the fake snake prop. Otherwise, he has to be bribed with the junk food he is currently craving, and a good coffee (the sort that costs at least 50eb) to clear the workshop and let them use it for a few minutes.

Darrel Marchant is originally hostile when he answers, if only because his Agent does not recognize the Agent of the Edgerunner calling him. *"Who is this? If you're one of those gossip hound, shit-vid assholes I have nothing to say to you."*

Use of Etan's password will render him temporarily silent, and then he speaks back up. *"Tell Etan I'm not interested in getting back in his bed."* He will calm down somewhat if the Edgerunner explains the situation, however.

*"So that's where they were. Yes. I do want them back. No, I understand why he can't deliver them in person. Yeah, that is decent of him." He sighs. "I don't have any engagements for the night, so it's probably best if you come along and deliver them to me right now, before word gets out. I don't know how, but that Malarkey fucker — never mind. Security will still be up. Have your Agent check out with my security program and you'll have a five-minute window to enter the yard. I'll be there."*

## GO TO CLIMAX (LOVELY HOUSE)

### CLIMAX (LOVELY HOUSE)

The trip to Little Europe is a fairly uneventful one. Edgerunners who have retained the presence of mind to check their vehicle for bugs may search with a Conceal/Reveal Objects Check (DV 17). Success indicates that they find at least two devices, which are easily disposed of by crushing under a boot heel or a weapon butt. Knowing Malarkey, though, this

# POPCORN-FLAVORED KIBBLE

might not be the only means by which he's gathering information on his marks, so they should still keep their guard up.

Darrel Marchant's home is lovely — it's an old stone-shod building that survived the 4th Corporate War, and has recently been renovated with contemporary materials, while preserving the historical façade. It is covered with what appears to be ivy at first sight, but a closer examination reveals each of the ivy leaves to be a synthetic bioengineered solar panel, likely to keep the home's security systems online even in the case of an extended power outage.

An advisory pops up on the Crew's Agents the moment they approach the gate, telling them that it is private property, and that trespassers will be shot. An encrypted handshake takes place between the Agent of the Edgerunner who called Marchant and the system, however, and the security goes passive for the few minutes required to cross his gently (artificially) overgrown garden.

The front door opens the moment the Crew steps up to the porch to reveal Marchant (**SEE PAGE 50**), clad in a t-shirt and a pair of sweatpants, carrying a Heavy Pistol, just in case. There's a rough charm to him even on first meeting to give the Crew the impression of what made Sim fall head-over-heels for him.

The moment the door opens, Malarkey rushes up to the fence and points his eye-mounted camera in Marchant's direction.

"You asshole!" Marchant yells the moment Malarkey reveals himself. He brings his pistol to bear, aiming it swiftly and carefully, but hesitates to pull the trigger right away because, like any seasoned professional, he needs to make sure there isn't anyone he might accidentally kill should he do so.

"Go ahead, shoot me, see how that looks on my vid-show. I've got a Trauma Team membership right here!" Malarkey crows, in return, as his escorts also reveal themselves.

None of them has a weapon drawn, so they're just standing in front of someone else's house minding their own business.

With the right editing of his footage, Malarkey could make a lot of trouble. The Crew has A Problem. Several problems, in fact.

BY HÉLIO FRAZÃO



Darrel Marchant

- **Problem #1:** If Darrel Marchant commits murder right now, it's going to be bad for him and for Etan, if the Edgerunners care about that. Little Europe is a nice neighborhood, which means Corpo police, and that's if Malarkey's Security Escort doesn't maim Darrel first. Moreover, Edgerunners who did bug Etan Sim's trailer are going to need Malarkey alive to get paid.
- **Problem #2:** Should the Edgerunners dissuade Marchant from killing Malarkey. Malarkey is going to run off and edit their little interaction into something salacious. That is going to be bad for everyone except Malarkey. That includes the Edgerunners, who will see their faces plastered all over the Data Pool. Malarkey doesn't know what "friendly fire" is. He'll throw his grandma under a bus if it gets him more shares.
- **Problem #3:** All this is happening while one of the Edgerunners has a very fragile set of hand-made ceramic plates in their arms. They need to get the box somewhere safe before a fight erupts.

# POPCORN-FLAVORED KIBBLE

Malarkey (**SEE PAGE 50**) is smart enough to leave any fighting to his muscle (use **Bodyguard**, **PAGE 172**). There's one per Edgerunner.

The Crew has several options to resolve this standoff.

- A clever Edgerunner could fling a random object at Malarkey and convince him that it is a grenade with a DV 17 Acting or Persuasion Check. That would startle him, at which point the Crew could hustle Marchant and their precious cargo safely indoors where the security system would do the rest.
- Someone in the Crew could simply start filming, if they haven't already, and turn the tables on Malarkey with a well-timed upload to their Garden Patch (**SEE CP:R PAGE 280**). Malarkey's own jeering taunt is ample ammunition for the kind of people who watch his show, and the visual of him trying to get a recently-divorced man to shoot him over a continued campaign of harassment would have said viewers turn on him for the ratio-ing of a lifetime. Revenge is sweet, no?

- Or the Crew could simply let Darrel pop Malarkey in the face, duck out of the firefight, and let Marchant's presumably powerful attorneys sort it out? Perhaps? Of course, Malarkey's security escorts aren't exactly the most disciplined of shooters and might actually hurt someone else in the crossfire. That might not matter to some Edgerunners, though.
- Edgerunners may attempt a non-lethal takedown where they bonk the living daylights out of Malarkey and his crew and justify their violence to the law as a citizens' arrest of a trespasser, especially if they pull him off the sidewalk and into the yard. If they go this route, Darrel will insist they avoid trampling the Biotechnica RealBlooms™. They're a limited edition and the color is no longer available.

Players are encouraged to come up with creative and entertaining ways to deal with the approach and the problem of Malarkey's ambush. Bonus points if they manage to punk him non-lethally so nobody gets in too much trouble.



BY AGUSSW

# POPCORN-FLAVORED KIBBLE

Once the situation has calmed down, the Edgerunners are able to hand the plates over to Darrel, who thanks them. If they manage to deal with Malarkey without getting the law involved, he invites them inside for a beer (and soda for teetotalers), and tells them he owes them a favor for that.

He hands them a calling card with his work contact info, but scrawls his personal number on the back, which the GM is encouraged to exploit for a plot hook. Then he carefully puts the plates his mother made in a glass vitrine where the rest of the set lives, and smiles a little sadly at the sight of all the pieces reunited again.

If the law gets involved, Marchant is too busy being questioned to do more than thank them. But later, he sends confirmation of the delivery to Etan Sim, and the Crew receives the promised 1,000 Eurobucks shortly after.

## GO TO RESOLUTION (THE SPOTLIGHT)

### RESOLUTION (THE SPOTLIGHT)

At this point, the Crew are at a loose end, and the GM can do a time-skip to get them to their fifteen minutes of fame. This, however, depends heavily on some of the Edgerunners' decisions.

If they chose to acquire a copy of the script for the Simwives, one of the impressionable teenagers will have posted spoilers online despite their promise to use it only to learn Etan Sim's lines. This has caused security at the shoots to ramp up quite impressively.

If they chose to bug Etan Sim's trailer for Malarkey: Guess what? Malarkey doesn't actually pay up, because he's a jerk. If he's still alive after the Crew's confrontation with him in the Climax, they may wish to follow up on him and get the money he promised them.

If the Crew decided to acquire a copy of the script **and** bug Sim's trailer security will have puckered up tighter than a sea cucumber's mouthparts. A sweep of the security footage will have placed them at Sim's trailer shortly before the bug turns up, which means their contracts are now rendered null and void and they are going to be gently (or forcibly) disinvited from the shoot when they show up.

If the Crew only did one or neither of the two dirty deeds, however, they get to experience two wonderful days of filming a protest scene outside the hotel! Props has acquired supplies for sign-making so the Crew can make as deranged a sign as tickles them. They also get to wear some seriously vintage clothes to match the 2000s setting of the movie. It's hot, sweaty work for hours at a time for 200eb a day and the promise of exposure, which may not feel particularly worth it even if said exposure is in the form of their elbow (glimpsed at a corner of the shot) as they raise their sign and wave it while Mael Cartaret runs sobbing by them in the dramatic scene where she flees her Yakuza handlers and sprints towards Etan Sim's protective embrace.

Once the shoot's done, have each Player roll a 1d10 at this time. Any LUCK remaining can be spent on this. With a 6 or greater, their shot did not end up on the cutting floor, and they are visible on the big screen. Hell yeah! When the movie debuts, the lucky Edgerunners can parlay their brief appearance into a free drink or two.

If the Crew helped Cookie, Buck, and Etan and did not steal a copy of the script or plant the bug, the Senait Sisters include a gift basket of real Ethiopian coffee beans and crew-only coffee mugs with their production company logo on it. There are enough coffee beans to flog in Night Markets for a sweet payment of 500eb. Included also is a calling card with the work number of their local producer, Juri McCullough, who might have more movie-related work for the Crew to help out with in the future.

## A BIT ABOUT THE MOVIE

*The Parisian Hostess* tells the story of a pair of star-crossed lovers, one a popular bar hostess and the other a rough and tumble Edgerunner. It all takes place in the early 2000s as the populace and Megacorps began turning on the various criminal organizations running Night City. The bulk of the action occurs in the Parisian, a Yakuza front business and theme hotel where staff and guests all dress up in late 1800s costuming. The Parisian has long since shut down but the building remains and has been dressed up in a semblance of its original glory for filming.

# POPCORN-FLAVORED KIBBLE

## NPC STAT BLOCKS

For more information on important NPCs **SEE APPENDIX B: BIOGRAPHIES.**

SEE PAGE 189 FOR BIOGRAPHY

<b>NAME</b>	<b>MARKUS "MALARKEY" BORNHOLM (REP 4)</b>		<b>SERIOUSLY WOUNDED</b>	<b>20</b>	<b>HP</b>	<b>40</b>											
<b>ROLE</b>	<b>MEDIA: CREDIBILITY 5</b>		<b>DEATH SAVE</b>	<b>5</b>													
<b>STATS</b>																	
<b>INT</b>	<b>7</b>	<b>REF</b>	<b>5</b>	<b>DEX</b>	<b>5</b>	<b>TECH</b>	<b>4</b>	<b>COOL</b>	<b>8</b>	<b>WILL</b>	<b>7</b>	<b>MOVE</b>	<b>7</b>	<b>BODY</b>	<b>5</b>	<b>EMP</b>	<b>4</b>
<b>WEAPONS</b>				<b>ARMOR</b>													
HEAVY PISTOL				ROF2	3d6		KEVLAR® (HEAD)		SP 7								
NONE				—	—		KEVLAR® (BODY)		SP 7								
<b>SKILL BASES</b>																	
Athletics 7 • Brawling 7 • Bribery 14 • Composition 13 • Conversation 11 • Deduction 13 • Education 9 • Evasion 11 • First Aid 6 • Handgun 11 • Human Perception 13 • Language (English) 11 • Language (Streetslang) 9 • Library Search 11 • Lip Reading 13 • Local Expert (The Glen) 13 • Perception 13 • Persuasion 14 • Photography/Film 10 • Stealth 8																	
<b>GEAR</b>																	
Heavy Pistol Ammo x8 • Agent • Binoculars • Camera Drone • Homing Tracer x5																	
<b>CYBERWARE</b>																	
Cyberaudio Suite w/ Audio Recorder • Cybereye w/ MicroVideo																	

SEE PAGE 184 FOR BIOGRAPHY

<b>NAME</b>	<b>DARREL MARCHANT (REP 4)</b>		<b>SERIOUSLY WOUNDED</b>	<b>23</b>	<b>HP</b>	<b>45</b>											
<b>ROLE</b>	<b>SOLO: COMBAT AWARENESS 6</b>		<b>DEATH SAVE</b>	<b>8</b>													
<b>STATS</b>																	
<b>INT</b>	<b>5</b>	<b>REF</b>	<b>8</b>	<b>DEX</b>	<b>6</b>	<b>TECH</b>	<b>3</b>	<b>COOL</b>	<b>5</b>	<b>WILL</b>	<b>6</b>	<b>MOVE</b>	<b>6</b>	<b>BODY</b>	<b>8</b>	<b>EMP</b>	<b>4</b>
<b>WEAPONS</b>				<b>ARMOR</b>													
EXCELLENT QUALITY HEAVY PISTOL				ROF2	3d6		SKIN WEAVE (HEAD)		SP 7								
NONE				—	—		SKIN WEAVE (BODY)		SP 7								
<b>SKILL BASES</b>																	
Athletics 12 • Autofire 12 • Brawling 12 • Concentration 7 • Conversation 5 • Drive Land Vehicle 12 • Education 7 • Endurance 10 • Evasion 12 • First Aid 7 • Handgun 12 • Human Perception 5 • Interrogation 11 • Language (English) 9 • Language (Spanish) 7 • Language (Streetslang) 9 • Local Expert (Badlands) 9 • Local Expert (Little Europe) 7 • Melee Weapon 12 • Perception 11 • Persuasion 5 • Resist Torture/Drugs 11 • Shoulder Arms 12 • Stealth 9 • Tactics 11 • Wilderness Survival 9																	
<b>GEAR</b>																	
Heavy Pistol Ammo x8 • A nice house in Little Europe w/ a state-of-the-art security system and a basement armory • A broken heart																	
<b>CYBERWARE</b>																	
Cyberarm w/ Subdermal Grip • Cybereye x2 w/ Anti-Dazzle, Low Light/Infrared/UV • Neural Link • Skin Weave																	



# DRUMMER AND THE WHALE

## BACKGROUND (READ ALOUD)

*It seems like it's been raining for a week straight. The weather reports keep talking about the rain washing away the dirt and grime, but last night's caustic acid rain and the greasy blood rain the day before just made things dirtier. In times like these a person needs a hobby to keep them sane. Luckily, a local Fixer by the name of Rex Royale just got in touch. There's a client looking for a crew to do some "easy" work down by the bay. Sounds too good to be true but hey, anything beats sitting on the couch watching reruns of Hot Zone Divers and Pimp My Chrome.*

## THE REST OF THE STORY

A naïve corporate data wonk named Drummer is looking to hire a team of Edgerunners to do some grunt work on his hobby project.

Drummer likes patterns. He loves finding them. He loves watching them. More than anything, he loves understanding them. He does the dulllest of dull work: things like tracking microtrends in collected fault data for Raven Microcybernetics to build better repair predictions. However, in his off time, he and some acquaintances (calling themselves the Interesting Patterns Group) explore the broken, abandoned, and haunted leftover fragments of the glorious global NET.

While some people join the group looking for treasure or advancement, neither Drummer nor his close friend Fife are in this for power or money. It's all about the thrill of the chase and showing up their friends. Top explorers in the IPG, they've mapped out the remnants of EBM's abandoned voice message system. They built a moment-by-moment map of the collapse of the Trans-Pacific Backbone Routing System. In their latest expeditions, they've begun cataloging and analyzing ultra-low-frequency sonar sources that might represent old Megacorp assets deep in the ocean. Many of these are old repeaters with nothing hooked up to them, calling out to facilities or systems that no longer exist.

But not all of them.

Drummer calls it the Whale. At first it was just a series of ULF signals with a common encryption scheme. Then he discovered matching signals using the same encryption scheme irregularly popping up on the old optical

network. Then, Drummer and Fife connected them to the Beachings: a series of brand new, shiny cargo pods, sources unknown, that wash ashore around the Pacific on a complex, pseudorandom schedule. No known cargo line, facility, or system can explain their data.

Something's down there. Something mobile. Given how far back the signals started, whatever it is almost certainly dates back to the 4<sup>th</sup> Corporate War.

## So, WHAT IS THE WHALE?

Somewhere deep on the Pacific floor, an experimental crawler manufactory, a joint project of CINO and Arasaka before the war, has been quietly following its preprogrammed mission: scooping up resources on the ocean floor, processing them into both manufacturing ingredients and finished products, and then dropping its work at predetermined "depot" sites.

However, not a living soul knows its location. The whole CINO branch responsible for directing the Whale in its mission was wiped out in the same artillery strike that destroyed most of its sibling craft in the Philippines. Arasaka lost most of its attached personnel in the same strike, and the rest all died in unrelated actions by the time Night City ate the big 'shroom. Add to that the damage of the Net's physical and logical collapse? The project's utterly buried and the handful of remaining Arasaka Execs who knew about the project have had no luck uncovering any information relating to it.

The Whale survives by being cautious. It never surfaces, and its communication attempts are so rare and careful that only a team of obsessive geniuses like Drummer and Fife could spot the pattern—and even then, they used over a decade of data.

In the absence of new orders for specific operations, the Whale creates a set of "staples" to drop at its hidden depots: pods full of fuel, military-grade materials, and a few with finished weapons or armor. It only stops when it realizes a depot's been uncovered or destroyed. However, nobody coded a plan for what to do if a depot was grossly overfilled, as several of them now are. A few of the depots are so overloaded with cargo containers that natural currents are carrying some of them away. So far, it's just been a few isolated cases—meaningless without the record of quiet, careful signals.

# DRUMMER AND THE WHALE

This is the pattern that Fife and Drummer have spotted. All they really care about is the discovery: understanding where the pattern's coming from and making a cool find that nobody else could have uncovered. But *this* discovery has a load of implications, any of which could bring a massive hammer of consequences down on some poor, unsuspecting Night City choombas just trying to make a living.

## THE SETTING

The Crew begins on the Night City Waterfront at Rusty's Dive Shack, where they meet their first contact, Drummer, and get the details of the initial job. From there, they'll head to South Night City to search for the first cargo container, which recently washed ashore.

After finishing their first job, the Crew will be contacted by their second contact, Fife, who meets them at a bar called Yum Seng in the Watson Development to discuss their next job. This job takes the Crew deep under Morro Bay, to a series of ruined NCART tunnels where they'll find the second cargo container. Finally, if things go poorly, the Crew may wind up aboard the Militech submarine, SS MacDonnellson, where they'll have to escape custody or play along to save their skins.

## THE OPPOSITION

- **The Bar Brawlers** are a ragtag group of Boostergangers equal to the Crew minus one who frequent Rusty's Dive Shack. The Crew encounters them harassing Drummer and can choose to fight them or diffuse the situation.
- **The Macrocheira Class Crabform** is a custom-made arthropod protector that guards the second cargo container. It reacts violently to anyone who comes close to the container, but will prioritize threats marked with Militech logos.
- **The Militech NASS-52 Underwater Drones** are two high tech drones being used as scouts for the SS MacDonnellson.
- **The SS MacDonnellson** is a state-of-the-art Militech Submarine, staffed by a skilled crew and outfitted with a number of dangerous weapons including drones and the Growler Sonic weapon.

- **The Dive Team of the SS MacDonnellson** is a crew of trained underwater operatives outfitted with diving equipment and prepared to confront and capture the Crew when the SS MacDonnellson enters the climactic battle.

SEE PAGE 68 FOR STAT BLOCKS

## THE HOOK

Rusty's Dive Shack is a literal heap. The front of the bar is the recovered bridge and loading doors of an old IHAG container sub. The owners carved the rest out of a stack of containers welded together. As you push through the creaking doors, you're hit by a wash of briny, beer-soaked air and the raucous shouting of dock workers, off duty sailors, nomads, and pirates. The bar takes up most of the downstairs, furnished with old tables and mess benches from commercial subs and ships. You can see a salvaged airlock which looks like it leads into the dive shop and an elevator which must go up to Rusty's private office. But one thing stands out like a neon sign.



BY NEIL BRANQUINHO

Drummer

# DRUMMER AND THE WHALE

Toward the back of the bar you spot a skinny guy in an expensive corporate suit doing the worst possible job of being inconspicuous. Half the bar's watching a couple of sailors leaning on the guy while a few others slip outside, either to avoid what's coming or to get toiled up for it.

One of the sailors puts his arm around the corp with a greasy smile. "Why you here, Money? Meeting someone? Hiring? 'Cuz I can use some cash!"

"N-no, I just—" The Corp tries his best to squirm out from under the burly man's arm but gets blocked by a heavily tattooed woman before he can finish his stuttered sentence.

"Yeah, chooms! 'Bux here can hire us!"

The first guy gives the Corp a hearty slap on the back, sending him doubling over. "Maybe 'Bux bein' here is a secret, y'aw! 'Bux, you can pay up f'us keep eyes out!"

Before the Crew can talk to their client and figure out what the job is, they need to get rid of these gangers. The Crew can calm the curious sailors (use **Boosterganger**, **PAGE 172**. There are a number of them equal to the Crew minus 1) by buying them drinks with a DV 9 Bribery Check or succeeding at a DV 15 Persuasion Check. If the Crew fails either of these Checks the sailors become violent but won't fight to the death.

However, once the Crew has dealt with the sailors, they only have a few moments to speak with Drummer before a group of pirates (use **Road Ganger**, **PAGE 173**. There are a number of them equal to the Crew) who left to get geared up return with their weapons. These dedicated head-crackers are ready for a fight and can only be dissuaded with a DV 21 Persuasion Check.

Luckily, Drummer is used to taking orders from security teams, so he follows direction well. However, he's likely to freeze if violence starts and only move when someone *does* give him specific orders. If Drummer suffers a life-threatening injury, his corporate life-monitor summons a Trauma Team AV immediately. Needless to say, they're only interested in *his* welfare and may not take kindly to scruffy street types trying to thumb a ride with him.

## GO TO DEV (THE JOB)

### DEV (THE JOB)

Once the Crew has Drummer somewhere safer, he goes into a rambling explanation of ultra-low-frequency signals, underwater optical networks, and oceanic debris deposition that really doesn't explain much. A Crew member who makes a DV 21 Cryptography or Electronics/Security Tech Check is able to piece together that Drummer tracked down a series of ULF signals from something at the bottom of the Pacific ocean and managed to determine that whatever made those signals has been depositing cargo containers at hidden locations on a semi-random schedule. After rambling for a minute, Drummer finally gets to business.

"There's a submarine cargo container somewhere on the South Night City beach or seawall. Or at least there should be. Um, I want you to find it. I know there are lots of wrecked containers in Morro Bay but this one should



BY NEL BRANQUINHO

stand out: it'll be brand new. A big, carbon-resin thing with new paint and no logos. I don't have any photos or I'd share them. I don't really care what happens to the contents, but I need any information you can get from it that would help figure out where it came from. RFID chips, Bar Codes, Serial Numbers. Anything. I can pay you each 500eb."

## GO TO CLIFF (BEACH BLANKET ROULETTE)

### CLIFF (BEACH BLANKET ROULETTE)

The long section of beach that Drummer directs the Crew to is a mix of warehouses, flophouses, and smash-houses. None of them are safe. Few of them are legit. The roads are bad. The handful of legitimate businesses that operate here directly cater to 'gangers, criminals, and addicts.

The rest are usually straight-up illegal. While there are technically security patrols, few of them are more than protection rackets. Much of the seawall was constructed by the lowest bidders and is barely maintained. Lawsuits are ongoing, but in the meantime it's risky to get too close to the water unless you're at one of the few legitimate corporate docks.

Recovering the container is a whole adventure in itself. Waste of the medical, industrial, and (worst of all) the human varieties are everywhere and the sprawl of shanty buildings make visibility on the waterfront minimal.

The Crew will have to make their way up and down the beach searching among the wreckage and refuse for the container. The beach can be divided into 6 sections. When the Crew searches a section of the beach have each member make a DV 17 Perception Check.

- If at least two members of the Crew beat the DV when searching a given section, they have found the container.
- Whenever two or more members of the Crew fail to roll above a DV of 13 on any of these Perception Checks, roll on the Hazard Table to see what happens to them.

Once they've found the container, **GO TO DEV (REPORTING IN)**.

## HAZARD TABLE

1d6	Hazard
1	A group of <b>drunken 'gangers</b> of equal number to the Crew come of out a smash-house, looking for a fight (use <b>Boosterganger, PAGE 172</b> ). They can only be talked down with DV 21 Persuasion Check or a DV 13 Bribery Check.
2	A band of <b>pickers</b> (use <b>Road Ganger, PAGE 173</b> ) are scavenging the area. They make it clear they'll fight to defend their patch of sea wall though they won't fight to the death. They may shadow the Crew if they look like they have a promising lead on something good.
3	<b>Loose wreckage</b> shifts underfoot, toppling into the water—along with anyone standing on it. All Crew members must make a DV 15 Athletics Check to avoid falling into the water and suffering 1d6 damage that ignores armor as the shifting concrete and carb-rebar collapses onto them. Those who fall in are trapped underwater and must make a DV 13 Athletics or Contortionist Check to escape from under the rubble and reach the surface.
4	The tide has come in, submerging the area in a <b>sludge</b> so thick, so oily that it permanently and very visibly stains any cloth it touches. The clothes remain functional, but how can you wear your Joe Chiba beret in public with nasty smears on it? This kilometer stretch of the beach remains affected for the rest of the day.
5	A swarm of biting <b>insects</b> descend on the area. Gnats, mosquitoes, sand flies or some other nasty bugs begin to crawl into the Crew's clothing. All Crew members take a -1 to all non-combat Skill Checks that require their attention or focus until they leave this kilometer stretch of the beach. This section of the beach remains affected for the rest of the day.
6	Who threw that out? Something <b>valuable</b> , like a wallscreen, weapon, or even a nice piece of furniture is buried among the refuse. The object is worth up to 100eb. Why it was left out is up to the GM.

## CASHING IN

*In the meantime, there's still a load of little mystery balls that may or may not be worth some money.*

*With a DV 13 Science or Basic Tech Check a Crew member can identify the balls as high-grade, purified manganese and ceramic components used to make ceramic armor.*

*If they want to use the goods themselves, a Tech with the Fabrication Expertise can use all of the materials to Fabricate 1 suit of Metal Gear (Basic Tech Check DV 29 and 1 months' time) or 4 suits of Flak (Basic Tech Check DV 21 and 1 weeks' time per suit). Alternatively, a Tech with the Upgrade Expertise can use all of the materials to upgrade 1 vehicle with a Combat Plow and a Heavy Chassis (Vehicle Tech Check DV 21 and 1 weeks' time per upgrade).*

*The Crew can instead sell the materials via a Fixer, a Night Market, or a Midnight Market. The total value of the capsule and its contents is equal to 2,000eb per Crew member. A Fixer can find a buyer with a DV 17 Trading Check. Anyone else must spend a day searching and roll a DV 21 Trading Check to find a buyer.*

## DEV (REPORTING IN)

Braving the dangers of the Night City Waterfront, the Crew finally finds the container: a sleek, coffin-sized capsule of white-painted carbon fiber nestled among the rubble. Once the Crew informs him of their find, Drummer excitedly reminds them search the container for barcodes, RFID tags, or any other identifying marks. However, even a careful search yields only a single barcode and a very simple RFID chip located next to the container's hatch.

If the Crew informs Drummer of this he suggests that maybe there's more inside and asks the Crew if they can open the container. Using a built-in hand crank the Crew can open the capsule, revealing its load: two separate compartments full of dime-sized balls, metal in one and ceramic in the other.

Drummer's disappointment at the results is obvious, but he tells the Crew they can keep the little balls—whatever they're worth. He just wants one of each to analyze. He then asks the Crew to meet him at the Short Circuit in Little Europe to drop off the goods and get paid. When the Crew gets to Short Circuit, Drummer is subdued and glum.

*"I guess I thought it'd be something more... interesting."* He buys a round of drinks but leaves without having anything himself.

## GO TO DEV (THE SECOND BITE)

## DEV (THE SECOND BITE)

A few days pass with no news. Things may seem to be over, but then each member of the Crew gets a message from someone called Fife. *"Tired of the ocean yet? More money if you're willing to dive back in. Don't worry. I'm a friend of Drummer."* The message includes passes to a karaoke room at a bar called Yum Seng for the following evening.

Yum Seng is a hole-in-the-wall karaoke joint in the Watson Development which caters to the large Asian population moving into the district from Little China and Old Japan Town. The bar's storefront is a riot of light and color. Barkers on the street wearing luminous clothing call out to passers-by to come inside for a good time. A large holotank mounted above the door shows hyper-real images of tuna, salmon, eels, octopi, and shrimp, all life-sized or bigger. They swim alluringly by overhead, hinting at the high-end seafood served inside.

As the Crew approaches, a holographic neon otter swirls into view, snatching one of the fish. It bobs its head toward them in greeting, then swims off as if going inside. If they watch closely, the otter pops up on screens ahead of them inside the bar as they walk to the karaoke room.

In the karaoke room, someone's set up a large holotank with a few chairs placed around it. It sits idle until the last member of the Crew arrives. Then it switches on, bringing up the image of a huge cetacean eye. The figure in the tank shrinks and changes quickly from a blue whale into a dolphin, which waves its fins in a clear greeting.

*"My name's Fife!" the dolphin says. "Drummer is my friend—we share the same hobby. I guess you could call us data watchers." Fife explains their hobby more clearly than Drummer had been able to. They and Drummer are members of a group that love to explore data out of simple curiosity, reconstructing orphaned systems and even scanning the ruins of the Old NET, especially the networks that used to crisscross the Pacific seabed.*

*"We all love puzzles. We've unscrambled old voicemails from EBM's satellites. Drummer and I found the lost ships of the Busan Exodus based on public records. He's even developed safe ways of getting some data out of old Ihara-Grubb-based systems, though it's often pretty jumbled. Drummer asked me to help with this 'whale*

# DRUMMER AND THE WHALE

hunt.' I love it when he gets excited, and I know he's onto something. He's sad now. I hate that. He was so sure he had the trail, and now the water's gone still for him. He says there's no way to find it now. I keep telling him there must have been more than one container, but he's gone sad and boring and wants to sulk. So I went and did the math myself. And I think I can figure out where the containers are coming from. All I need is one more container to cross reference with the data you found with Drummer. And we're in luck. Night City's old transit system collapsed during the war, but it's still down there and big parts of it are open to the sea. Drummer isn't as good with the flow of water as he is with data. But I've re-done his model, and I'm pretty sure one of those pods got swept down into the old NCART tunnels. All I need are people who can go down there and get it. Maybe if we can find the coordinates for Drummer, he'll be happy again!"

Fife offers to pay 1,000eb per Crew member and supply equipment for the Crew to retrieve the container in the old NCART tunnels. It'll be underwater work, but only one or two hundred feet down. With the right gear, it should be easy enough.

## GO TO DEV (DIVE! DIVE! DIVE!)

## DEV (DIVE! DIVE! DIVE!)

Fife asks the Crew to meet them at a nondescript dock in the Upper Marina as soon as possible. When they arrive, they are met by a partially submerged submarine which was obviously salvaged from the sea bottom. It's a big, sturdy, industrial design covered in lights and equipment. Its paint is chipped and there are plenty of dings and dents on its fittings, but it appears to be quite sturdy and carefully maintained. The hatch opens remotely, allowing the Crew inside, where they find an empty cabin. The only notable thing inside is another holotank installed by the pilot's seat, with a pack of holographic otters swimming in and out of it excitedly. Fife assures the Crew that they will be piloting the submarine remotely and tells them to get suited up with the provided gear at the back of the cabin.

If the Crew chooses to question Fife on why they insist on using holograms and remote communication, they are initially reluctant to explain for fear of putting off the Crew. They give the excuse that what they're doing isn't exactly legal and they don't want anything to trace



BY DANI HARTEL

back to them, though a Crew member who makes a DV 15 Human Perception Check can tell this is a lie. If a Crew member makes a DV 21 Persuasion Check or a DV 17 Interrogation Check they can convince Fife to explain why they prefer remote communication. Their explanation is simply that they've undergone a number of exotic bio-sculpts which might make them off-putting to the average person. If the Crew convinces Fife to explain while they are in the submarine, Fife will swim up to the porthole to allow the Crew member to see them.

Several racks full of tools and diving gear line the rear wall of the cabin and contain the following.

- **Dry Suits:** Full body, neoprene suits (SP 7), which can be worn to keep the Crew member dry in the water. One per Edgerunner.
- **Flippers:** Plastic flippers which can be worn to negate the movement penalty imposed when swimming. One per Edgerunner.

# DRUMMER AND THE WHALE

- **Diving Helmets:** Armored, plastic helmets (SP 7), which have a glass view port, a mounted flashlight, and a mounted video camera which relays back to Fife's Submarine. One per Edgerunner.
- **Diving Rebreathers:** A complex, harnessed device which provides oxygen to the Crew member and keeps them neutrally buoyant. One per Edgerunner.
- **Radio Communicators:** One per Edgerunner.
- **Techtools:** One per Edgerunner.
- **Dosimeter Badges:** Designed to alert the Crew member when they come within 10m/ yards of dangerous levels of Radiation. One per Edgerunner.
- **Two Remote Operated Vehicles (ROVs):** Ground Drones (**SEE PAGE 70**) modified to maneuver underwater. Each one is connected to the submarine's NET Architecture (**SEE PAGE 66**).

## GO TO CLIFF (CLEARING THE WAY)



## CLIFF (CLEARING THE WAY)

As the Crew gets suited up, Fife pilots the submarine out into the bay. Despite their assertion that they're piloting the submarine remotely, Fife is actually riding on the underbelly of the submarine, using a pair of sheltered handholds so that their connection with the ship's NET Architecture isn't broken.

The initial part of the cruise can be fun, looking up at the yachts and seeing the footings of the old and new Del Coronado Bridges. Then, as the sub travels onward and downward, the amount and type of wreckage begins to change. Twisted I-beams. Piles of burned-out vehicles. Chunks of buildings. Even a cargo ship with its superstructure visibly melted and blasted. All evidence of the radioactive rubble that was scraped out of the city and dumped in the ocean after the Night City Holocaust.

*"Don't worry," Fife says, "I'm avoiding the really hot spots. I found a broken ship one time that was giving off Cherenkov radiation—can you image? Glowing and everything!" They chuckle.*

The sub corkscrews carefully into a chasm in the seabed, sinking almost straight down into the dark. As it sinks, the work lights pick out even more remnants of the catastrophe. There's clothing that hasn't broken down, household appliances, and even the occasional cyberpart sticking out of the grime.

Finally, the sub reaches a broad ledge. *"Should be right up here," Fife says, coaxing the sub in closer and closer to a dark space in the wall, stopping at times to use the sub's manipulators to clear away dangling bundles of cables, including a cloud of thin structural microfiber. If anyone onboard can direct an ROV either by hand or on the network, Fife asks for help.*

*"Don't want those getting into our impellers," Fife says. "I doubt you all want to walk home!"*

The ROVs are semi-autonomous, so the operator's job is to give commands (forward slow, grab or release target, re-dock with sub, etc.). Directing the ROVs relies on the Concentration Skill but a Crew member with the Pilot Sea Vehicles Skill can steer the ROV by hand if they wish.

There are 2 large cables blocking the sub. They can each be shifted with a DV 9 Concentration or Pilot Sea Vehicle Check.



# DRUMMER AND THE WHALE

## CLIFF (PACIFICAN STAND OFF)

As the Crew moves into the tunnel, Fife swims into cover nearby (about 8 m/yds away), staying in contact by Radio Communicator.

The Militech drones (**SEE PAGE 70**) move quietly toward the scene for a better look, too. Even though they're 12-foot torpedoes, they're essentially silent, only apparent to the eye. A Crew member must make a DV 17 Perception Check to spot them. They only close in on the sub once they see the Crew enter the tunnel. Of course, they're not expecting an Exotic like Fife on the site.

Once the drones are within 30 m/yds of the sub, Fife sees them. *"Ah. Um, I didn't expect this, but we have visitors snooping around out here. Everyone just be calm and let's hope this is nothing."*

Barring any provocation, the drones split up. Their orders are to follow the group, record and relay what they find, and potentially capture the Crew if it's obvious they're handling contraband. Drone One moves into the tunnel after the Crew. Drone Two surveys the submarine, then hovers over it, keeping an eye on Fife. Anyone inside the sub can hear the quiet wash of its impellers as it maneuvers.

Meanwhile, inside the tunnel, the cargo container's protector (**SEE PAGE 70**) senses disturbances in the water. It's covered in detritus that makes it very difficult to notice (DV 17 Perception Check). It doesn't act against humans or animals unless they get very close (4 m/yd) to the container, in which case it strikes and then returns to guarding. However, the crab's orders assume the War is still going on. If it sees a Militech logo or encounters military vehicles or drones that don't return a valid Arasaka/CINO IFF (Identify Friend or Foe code) when challenged, it immediately attacks.

So the Crew, if they move carefully, won't set it off until they try to approach the container. But the moment one of the Militech drones heaves into view, the crab sends an IFF pulse. When the drones do not correctly acknowledge it, the crab attacks.

The crab moves directly toward the drones, striking at anyone en route, but not staying to engage them unless they've fired first. It assumes the drones are the major threat. If the Crew are incredibly restrained, they might get out of the way and have a chance to escape the fight.

However, though the drones recognize the crab as the major threat, they assume the Crew must be allied with it. Militech would like to capture and interrogate them, but not at the risk of losing its expensive drones. Because Drone One is in the tunnel, it's been ordered to use its Circular Saw (Very Heavy Melee Weapon) to defend itself rather than its Torpedoes. Outside the tunnel, Drone Two remains focused on Fife and Fife's Submarine and will only get involved if Drone One is destroyed or if something leaves the tunnel.

## TORPEDOED

The battle in the decommissioned NCART tunnel is far more dangerous than it seems at first glance. With crab claws, buzz saws, and possibly bullets flying, the unstable tunnel is at real risk of collapse. If any combatant misses their attack Check to hit a target in the tunnel, the attack instead strikes the tunnel wall and deals damage to the tunnel's HP. Additionally, an explosion in the tunnel deals damage to the tunnel's HP automatically.

The area's wreckage as a whole can take 35 points of damage before it begins collapsing. After that, silt begins drifting from the ceiling and deep groans resound through the water.

Every further damaging impact or explosion causes immediate falls of wreckage in a 6 m/yd radius around the point or area struck. Anyone in that area must immediately make a DV 15 Evasion Check or take 6d6 damage and be trapped under the rubble. After being trapped, the character must make a DV 15 Athletics or Contortionist Check on their Turn to get free. Mud and silt also fill the water in that area, blocking line of sight and imposing a -4 to tasks or attacks that require sight, just like a Smoke Grenade (**SEE CP:R PAGE 347**).

After five such impacts, the wreckage falls become constant. Anyone in the tunnel must make a DV 10 Evasion Check at the start of each of their Turns to avoid being hit by wreckage. Also, water throughout the entire tunnel becomes muddy and hard to see through, as described above.

## MANAGEMENT DECISIONS

Fife went on this little adventure to cheer Drummer up by finding the next piece of his puzzle. This had all been an intellectual exercise up until now. Now their life is on the line. Fife feels some responsibility for their

# DRUMMER AND THE WHALE

hirelings but won't risk their own life for anyone else. On the other hand, there's a military drone between Fife and the sub.

Fife doesn't have a combat mentality. That's what hired street types are supposed to be for. As soon as fighting starts, Fife calls the Crew. *"Time to go! Those things could set off a collapse—get back to the sub!"*

Fife watches for a chance to reach the sub unseen. In the meantime, if they can use the sub's manipulator arms (which can be used as Cyberarms or Heavy Melee Weapons) or tools to tip combat in their favor, they'll do so.

If combat stirs up the muck, the resulting plume of silt and dirt from the tunnel surrounds the submarine and the drone in a 10m/30yd radius area of dirt. This low visibility causes Fife to lose sight of the Submarine and the Drone and obscures the outside world to everyone in the Submarine as if they were in the area of a Smoke Grenade.

In two circumstances, Fife immediately leaves:

- If Fife thinks the whole Crew are beyond help, they attempt to flee with the sub.
- If the sub is knocked out, Fife swims off on their own.

## ENEMY CONTACT

There's also the commando submarine (the Garfish-class *SS MacDonnelson*) full of Militech naval personnel out there monitoring their drones. They're in a delicate position. While they're technically in international waters, their drones are in Night City's jurisdiction. This happens often on both sides, and rarely becomes an incident. But when shooting starts, especially if Night City citizens die (or a bunch of seismometers go off because of an underwater landslide), that's a big escalation.

If the *SS MacDonnelson* itself has to go into Night City's waters, that's *really* big: it's a true military incursion and likely that the independent city state would call on the aid of their more powerful partners in the Pacifica Confederation.

Before the *SS MacDonnelson* engages personally, they wait to see how their drones handle the situation. As soon as one of the Drones is destroyed or seems outmatched, the *SS MacDonnelson* deploys a Dive

Team (**SEE PAGE 69**; arm some with Assault Rifles) to intercept the Crew and try to capture them, all outfitted with Rebreathers and Flippers in addition to their normal gear.

If the Crew makes it back to Fife's sub with the cargo container, **GO TO CLIMAX (PARLEY)**.

If the Crew makes it back to Fife's sub but doesn't have the cargo container, **GO TO CLIMAX (FISHY FLIGHT)**.

If the Crew ends up in a prolonged fight **GO TO CLIFF (UNDERWATER WAR)**.

## CLIFF (UNDERWATER WAR)

If the Crew decides to continue fighting and perhaps try to make it back to Fife's ship, the battle resumes but with the crew of the *SS MacDonnelson* at the top of the Initiative order. The Crew of the *SS MacDonnelson* operate the ship's weapons and maneuver the ship.

The two crew members in the Weapons Control room work together to fire and reload the Growler (**SEE PAGE 71**), while Commander Walsh makes any maneuvers needed for the *SS MacDonnelson*. The Commander has forbidden the crew from firing the Torpedoes to avoid causing a stir underwater that might be recognized by the city above, but the Growler itself doesn't cause the same recognizable signature.

On Round 5 of the combat, the *SS MacDonnelson* (**SEE PAGE 71**) makes its way into the fray, leveling the Growler at the Crew. With a new, more dangerous threat on the board, Fife radios the Crew.

*"We can't win this fight! They have way too many guns! I don't even know what that thing on the belly of their ship is, but it looks military grade! Lay down your weapons and maybe we can talk this out!"*

Fife then swims out of cover and raises his hands in surrender.

Fife is whisked off the battlefield into the *SS MacDonnelson* by one of the Divers as soon as they can and if any of the Crew opts to surrender, the crew of the *SS MacDonnelson* will allow them to. They then take the Crew into the *SS MacDonnelson* as prisoners.

## GO TO DEV (THE FIFTH ACT)

# DRUMMER AND THE WHALE

## THE DOUBLE AGENT

While the Crew were being loaded into the Brig, one of the divers lugged the cargo container to the Gear Storage. This diver, Jaya Almazan, is actually a double agent, working for Arasaka. Once left alone with the container, she transferred the data on the container through a series of covert relays to an Arasaka ship further out in the Pacific.

This ship cross referenced the data with the numerous other containers it already found and relayed the path of the Whale to a group of Arasaka Submarines which have been combing the ocean floor looking for it. With the coordinates, the Submarines set off to destroy the Whale before it can be discovered.

## DEV (THE FIFTH ACT)

If the Crew agree to go quietly or are captured, the SS MacDonnelson's Dive Team takes them into the ship and strip them of their gear, excluding their clothing. The Crew's weapons, gear, and tools as well as the Cargo Container are all stashed in Gear Stowage. Anyone with obvious cyberweapons is placed in a separate cell and watched carefully by one of the Divers.

The Crew are left in the cell for what feels like a few hours, while the Militech agents examine the cargo container, looking for data. They are guarded by the remaining divers, save for one, who have been ordered not to speak with the prisoners. Fife is struggling to remain positive, assuring the Crew that if they just play along Militech will let them go with a warning. If the Crew chooses to fight the SS MacDonnelson, Fife is less positive, concerned that the Crew's actions may have doomed them to being carted off to a black site or killed and dumped in the ocean. Still, they try to be positive.

Eventually, Commander Walsh will come down to speak with the Crew. He strides into the room, confident of his position and says with derision: *"The United States Government thanks you for your cooperation, civilians. The cargo container you stumbled on is actually contraband, left over from the 4<sup>th</sup> Corporate War. Very dangerous and highly unstable. For the betterment of the Nation, we'll be transporting it back to Militech headquarters for disposal."*

Any Crew member who makes a DV 15 Human Perception Check is aware that this is a blatant lie on the part of Commander Walsh, and any Crew member who makes a DV 13 Streetwise, Local Expert (Night City Harbor) or Bureaucracy Check is aware that they are still in Night City waters meaning that the United States Government does not have jurisdiction here. This matter should be

resolved by the Night City Council. If the Crew points either of these things out, Walsh gets visibly irritated but then calms himself.

*"I'll give you one chance to end this in your favor, pirates. Because I'm feeling generous. Forget what you saw here today and you'll be compensated and let free. One hundred euro dollars for each of you. I'd rather this not have to get messy."*

## GO TO CLIFF (A DARING ESCAPE)

## CLIFF (A DARING ESCAPE)

As the Crew is being strong-armed by Commander Walsh, an alarm suddenly blares over the loudspeakers. Over the intercoms, a panicked voice says *"Commander Walsh, long range sensors just registered a shock wave off the coast! The blast must have been massive!"*

Commander Walsh goes pale and curses loudly before running out of the brig, headed for the Control Room. As he does, the remaining diver comes into the room with a duffel bag and says to the others, *"Go with the commander. I'll handle them."*

When the room empties, Jaya looks over the Crew, drops the bag in front of the cell, and walks to the door. *"Arasaka thanks you for helping us secure our lost asset. The airlock is down the hall to the left."*

Moments after Jaya leaves the room the cell doors open, letting the Crew loose. Inside the duffel bag is their gear, all exactly as it was when it was taken. By the time they get outside, Jaya is in the airlock, leaving the submarine. From here, the Crew has a choice. They can get the cargo container and leave through the airlock in which case they can sneak back to Fife's ship or they can try to investigate the MacDonnelson.

If the players try to chase down and confront Jaya, use the **Security Operative (SEE PAGE 173)**, equipped with diving gear. Jaya has no interest in

# DRUMMER AND THE WHALE

fighting the players and is under orders not to explain her mission further. She is heading for her personal submarine (**USE FIFE'S SUBMERSIBLE, PAGE 71**) which is floating just out of sonar range of the *MacDonnelson*.

Three Rounds after the Crew exits the Brig, the Balron in the Submarine's NET Architecture (**SEE PAGE 67**) spots the Crew through observation cameras, sounds the alarm, and activates the Mini Air Drone (**SEE PAGE 174**) in the Drone Bay on the bottom level. The remaining divers, who had been in the Command Deck scramble but a security officer remains on the Command Deck with Commander Walsh as protection.

If the Crew decides, for whatever reason, to try to take control of the *MacDonnelson*, **GO TO CLIMAX (TAKEOVER)**. Otherwise, **GO TO CLIMAX (SURFACING)**.

## CLIMAX (TAKEOVER)

The Crew of the *SS MacDonnelson* will fight to the death to keep control of the ship. If the Crew looks like they're going to take over the ship, Commander Walsh (or another crew member) will run to the controls on the command deck and activate the emergency scuttling program. Immediately after activation, the detonator charges along the hull of the ship blow open the two Engineering Bays, killing power to the ship. The ship's lighting switches to dim red emergency lighting, the NET Architecture shuts down, and the ship begins to flood with water. At the beginning of every Round, any room or hallway adjacent to a flooded chamber is flooded by seawater. After activating the Scuttling Program, Commander Walsh and the remaining crew attempt to escape the sinking ship and get to shore.

If the Crew somehow manages to take over the *SS MacDonnelson* before Commander Walsh or one of his subordinates activates the Scuttling Program,

they are now in command of a Militech Submarine which is also the property of the United States Military.

## GO TO RESOLUTION (END OF THE LINE)

## CLIMAX (PARLEY)

If the Crew manages to get back to Fife's Submarine with the cargo container, the Militech forces focus entirely on them. The crew of the *SS MacDonnelson* would rather take the cargo container whole and the Crew alive if possible and they hail the Crew.

*"Attention, unregistered vessel. This is Commander Walsh of the SS MacDonnelson. The container you have aboard your vessel is contraband. Under the jurisdiction of the United States Government I am ordering you to return the container and any and all associated materials. If you refuse, we will be forced to open fire on your vessel."*

Any Crew member who makes a DV 15 Human Perception Check is aware that this is a blatant lie on the part of Commander Walsh, and any Crew member who makes a DV 13 Streetwise, Local Expert (Night City Harbor) or Bureaucracy Check is aware that they are still in Night City waters meaning that not only does Commander Walsh not have jurisdiction but if he does open fire, it's very likely to cause an international incident. If the Crew points either of these things out, Walsh changes his tactic.

*"Who are you? Pirates? Nomads? Fine. If money is what you're after, I can promise you more than you'll find in that cargo container. Turn over the container and you'll be paid handsomely. Two thousand euro dollars per person and I won't mention this little incident in my report."*

If they are made aware of the Commander's bluff, and Fife is aboard the ship, they're adamant that fleeing is the best course of action. They plead with the

## DIVING THE NET

There are no Netrunners stationed aboard the *SS MacDonnelson*. Instead, they rely on the Balron Class Demon in the NET Architecture to handle intruders. There are still a number of Access Points in the ship. A Netrunner Crew member can find an Access Point to the *SS MacDonnelson's* NET Architecture in the following rooms: The Command Deck, Engineering (Upper), Engineering (Lower), and The Drone Bay.

From within the Architecture, the Crew could take over the ship, mess with the ship's security measures, command the ship's drones, fire the ship's weapons, or even unmount the Militech Growler to take. But they will have to contend with the Architecture and the Balron if they want to do any of that. If they feel that the Crew has the situation under control, Fife will help the Crew deal with the Balron.

# DRUMMER AND THE WHALE

Crew on behalf of Drummer and the mystery of the Whale. "You said it yourselves! He's bluffing! We can just leave! They can't do anything to us and we can take the container back to Drummer! We need to study this container! We need time!"

Still, not being a combatant, Fife is in no real place to force the Crew to do anything. If the Crew chose to hand over the cargo container, the SS MacDonnellson's Dive Team meets them outside the ship and hands off a credit chip with the appropriate amount of money. They take the container and head back out into international waters. **GO TO RESOLUTION (NOWHERE TO GO).**

If the Crew still decides to flee, there is very little Commander Walsh and the Crew of the SS MacDonnellson can do without getting themselves in deep trouble. They let the Crew leave, but the Edgerunners and Fife have made a powerful enemy with ties to Militech and in the USA Military.

Commander Walsh is a cunning man who has fought guerrilla wars before, and he doesn't forget a failure or a slight easily. **GO TO RESOLUTION (GETTING AWAY).**

If the Crew tries to double cross Walsh and take the money without giving him the container, the Dive Team will open fire with intent to kill the Crew. They can't afford to blow up the Crew's submarine, but they can clean up a few dead bodies in the ocean. **GO TO CLIFF (UNDERWATER WAR).**

## CLIMAX (FISHY FLIGHT)

If the Crew manages to get back to Fife's Submarine without the cargo container, the Militech forces shift their focus to securing the cargo container.

If any of their drones remain, Walsh orders one to follow the Crew and make sure they don't double back, but it stops following them after they get about 1 mile (1.6 kilometers) away.

If Fife is still alive, they join the Crew in their flight whether they were able to make it aboard the submarine or had to follow behind. The Militech operatives aren't interested in the Crew and won't give chase.

**GO TO RESOLUTION (NOWHERE TO GO)**

SS MacDonnellson Upper Deck

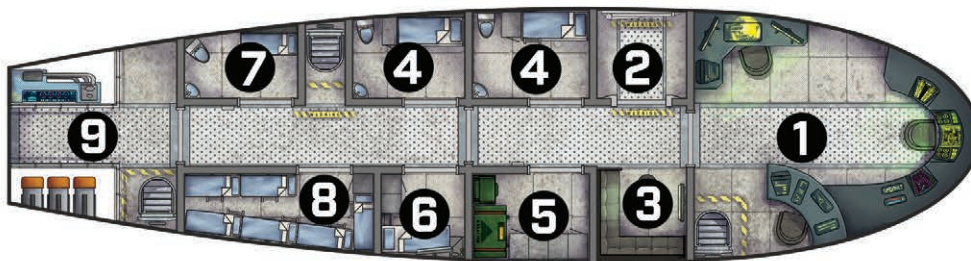

### Upper Deck

1. Command Deck
2. Combat Lock
3. Muster Area
4. Crew Cabins
5. Gear Stowage
6. Infirmary
7. Brig
8. Troop Cabin
9. Engineering (Upper)

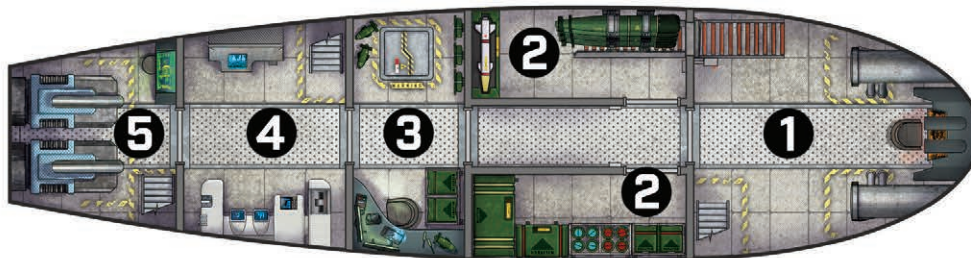

### Lower Deck

1. Weapons Control
2. Magazines
3. Drone Bay
4. Machine Room
5. Engineering (Lower)

SS MacDonnellson Lower Deck

BY ION ABRISS (PAPER GRIFFIN)



# DRUMMER AND THE WHALE

## NET ARCHITECTURES

### ► FIFE'S SUBMARINE

Demons Installed: None

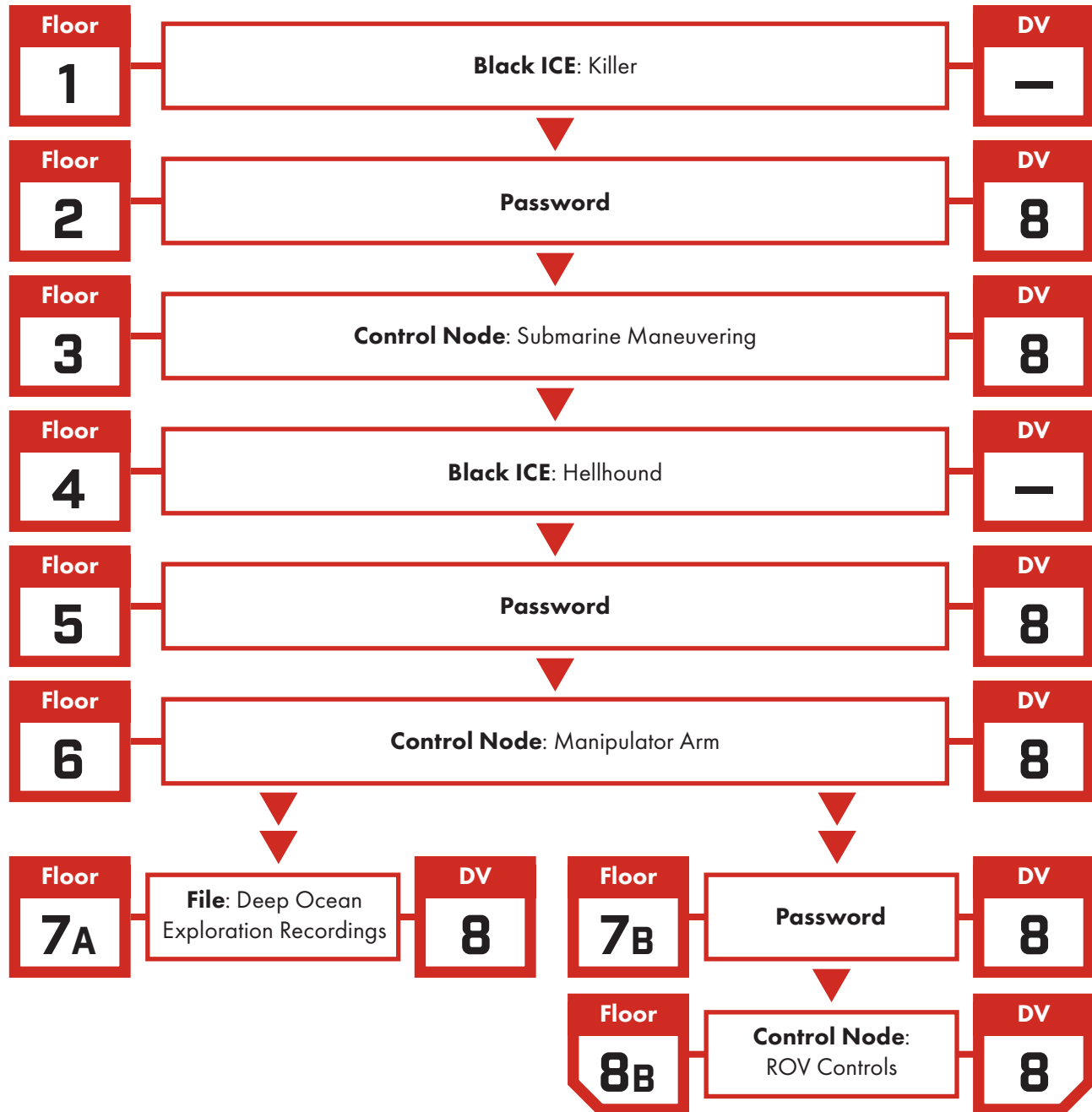

# DRUMMER AND THE WHALE

## ▶ SS MacDONNELSON

**Demons Installed: Balron (tasked to cameras and drones only)**

**REZ 30 • Interface 7 • NET Actions 4 • Combat Number 14**

Can perform any NET Action a Netrunner is capable of.

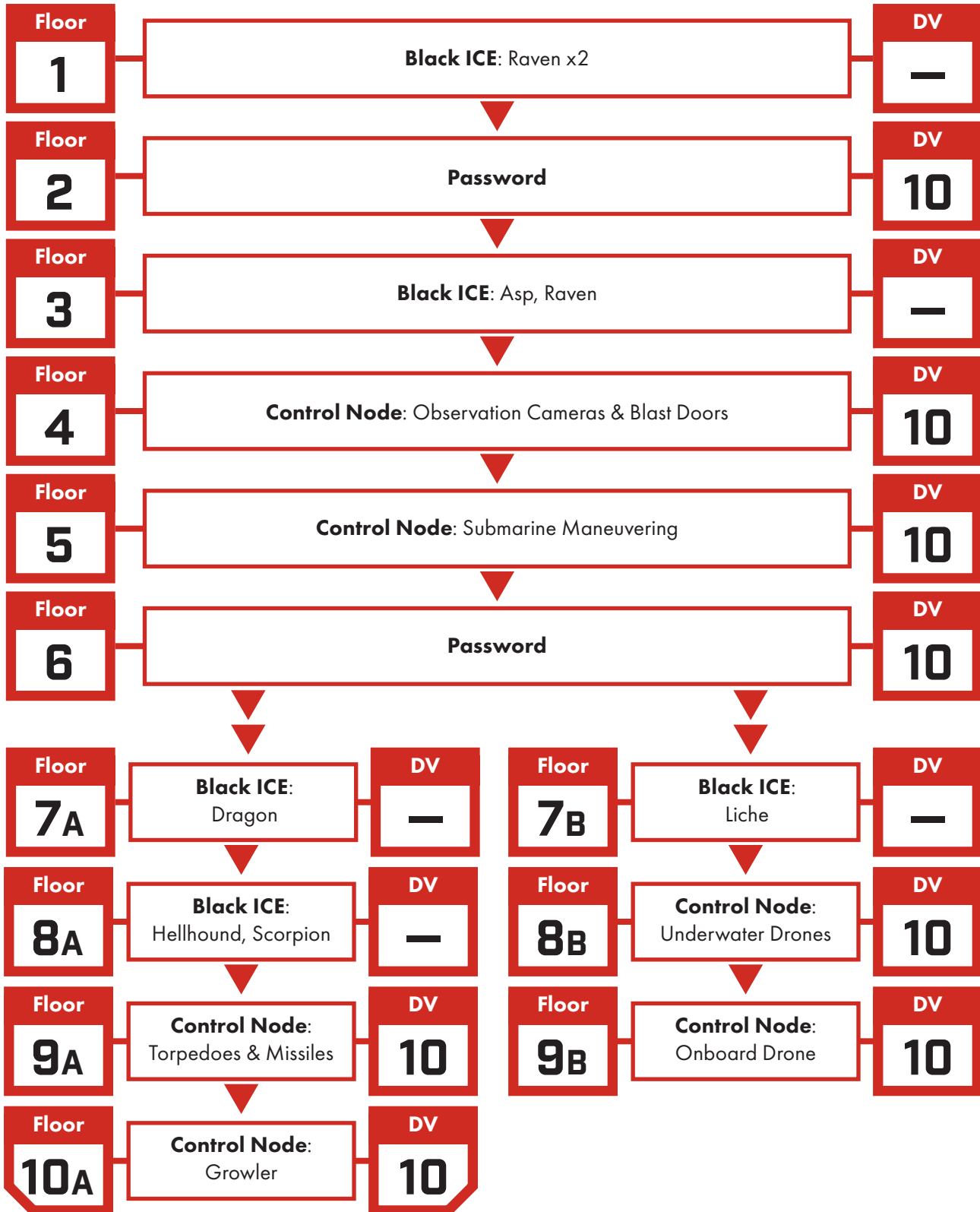

# DRUMMER AND THE WHALE

## NPC STAT BLOCKS

For more information on important NPCs **SEE APPENDIX B: BIOGRAPHIES.**

SEE PAGE 184 FOR BIOGRAPHY

NAME	DRUMMER (REP 1)	SERIOUSLY WOUNDED	18	HP	35
ROLE	NETRUNNER: INTERFACE 4	DEATH SAVE	4		

### STATS

INT 8 REF 5 DEX 4 TECH 8 COOL 4 WILL 5 MOVE 5 BODY 4 EMP 4

### WEAPONS

HEAVY PISTOL	ROF2	3d6	KEVLAR® (BODY)	SP 7
NONE	—	—	NONE	—

### ARMOR

### SKILL BASES

Athletics 6 • Basic Tech 13 • Brawling 6 • Concentration 9 • Conversation 6 • Cryptography 17 • Deduction 15  
Education 16 • Electronics/Security Tech 12 • Evasion 6 • First Aid 12 • Forgery 10 • Handgun 6 • Human Perception 7  
Language (Korean) 14 • Language (Streetslang) 14 • Local Expert (Little Europe) 9 • Library Search 15 • Perception 11  
Persuasion 6 • Pick Lock 11 • Resist Torture/Drugs 7 • Stealth 8

### GEAR

Heavy Pistol Ammo x8 • Agent • Anti-Smog Breathing Mask • Cyberdeck (Excellent Quality) • Memory Chip x10  
Trauma Team Silver Card • **Cyberdeck Programs:** Banhammer • DeckKRASH • Eraser • Hellbolt • Shield • Sword

### CYBERWARE

Biomonitor • Cybereye x2 w/ *Virtuality* • Neural Link w/ *Interface Plugs*

SEE PAGE 185 FOR BIOGRAPHY

NAME	FIFE (REP 1)	SERIOUSLY WOUNDED	18	HP	35
ROLE	NETRUNNER: INTERFACE 4	DEATH SAVE	6		

### STATS

INT 7 REF 5 DEX 4 TECH 7 COOL 4 WILL 5 MOVE 3 BODY 6 EMP 4

### WEAPONS

NONE	—	—	SKIN WEAVE (HEAD)	SP 7
NONE	—	—	SKIN WEAVE (BODY)	SP 7

### ARMOR

### SKILL BASES

Athletics 10 • Basic Tech 13 • Brawling 6 • Conceal/Reveal Object 11 • Concentration 12 • Conversation 6  
Cryptography 17 • Deduction 15 • Education 14 • Electronics/Security Tech 13 • Evasion 8 • First Aid 13 • Forgery 13  
Handgun 10 • Human Perception 8 • Language (English) 14 • Language (Streetslang) 12 • Local Expert (Night City Harbor) 16  
Library Search 11 • Perception 11 • Persuasion 8 • Pick Lock 13 • Resist Torture/Drugs 9 • Stealth 9

### GEAR

Aquaform Exotic Biosculpt • Waterproof Cyberdeck (Excellent Quality) w/ *Range Upgrade* • Radio Communicator  
**Cyberdeck Programs:** Banhammer • DeckKRASH • Eraser • Hellbolt • Shield • Sword • Worm

### CYBERWARE

Cybereye x2 w/ *Low-Light/Infrared/UV, Virtuality* • Cyberleg x2 w/ *Web Foot* • Gills • Neural Link w/ *Interface Plugs*  
Radar/Sonar Implant • Skin Weave.

# DRUMMER AND THE WHALE

SEE PAGE 182 FOR BIOGRAPHY

<b>NAME</b>	<b>COMMANDER AARON TYLER WALSH</b> (REP 3)		<b>SERIOUSLY WOUNDED</b>	<b>23</b>	<b>HP</b>	<b>45</b>											
<b>ROLE</b>	<b>SOLO: COMBAT AWARENESS 4</b>		<b>DEATH SAVE</b>	<b>6</b>													
<b>STATS</b>																	
<b>INT</b>	<b>6</b>	<b>REF</b>	<b>7</b>	<b>DEX</b>	<b>7</b>	<b>TECH</b>	<b>3</b>	<b>COOL</b>	<b>8</b>	<b>WILL</b>	<b>7</b>	<b>MOVE</b>	<b>5</b>	<b>BODY</b>	<b>6</b>	<b>EMP</b>	<b>6</b>
<b>WEAPONS</b>							<b>ARMOR</b>										
<b>VERY HEAVY PISTOL</b>							<b>ROF1</b>	<b>4d6</b>		<b>L ARMORJACK (HEAD)</b>			<b>SP 11</b>				
<b>LIGHT MELEE WEAPON (DIVE KNIFE)</b>							<b>ROF2</b>	<b>1d6</b>		<b>L ARMORJACK (BODY)</b>			<b>SP 11</b>				
<b>SKILL BASES</b>							<p>Athletics 14 • Basic Tech 6 • Brawling 14 • Concentration 14 • Conversation 8 • Deduction 10 • Education 10          Electronics/Security Tech 6 • Endurance 14 • Evasion 13 • First Aid 8 • Handgun 14 • Heavy Weapons 10,          Human Perception 10 • Language (English) 14 • Language (Streetslang) 14 • Local Expert (Pacific Coast) 16          Melee Weapon 13 • Perception 12 • Persuasion 12 • Pilot Sea Vehicle 16 • Resist Torture/Drugs 14 • Sea Vehicle Tech 10          Shoulder Arms 14 • Stealth 10 • Weaponstech 10 • Wilderness Survival 10</p>										
<b>GEAR</b>							<p>Very Heavy Pistol Ammo x16 • Agent • Memory Chip x5 • Radio Communicator w/ Scrambler/Descrambler • Techtool</p>										
<b>CYBERWARE</b>							<p>Cybereye x2 w/ Chyron, Low-Light/Infrared/UV • Cyberarm w/ Popup Shield • Gills          Neural Link w/ Chipware Socket</p>										

<b>NAME</b>	<b>SS MACDONNELSON CREW/DIVER</b> (REP 0)		<b>SERIOUSLY WOUNDED</b>	<b>20</b>	<b>HP</b>	<b>40</b>											
<b>ROLE</b>	<b>NONE</b>		<b>DEATH SAVE</b>	<b>6</b>													
<b>STATS</b>																	
<b>INT</b>	<b>5</b>	<b>REF</b>	<b>7</b>	<b>DEX</b>	<b>5</b>	<b>TECH</b>	<b>6</b>	<b>COOL</b>	<b>5</b>	<b>WILL</b>	<b>6</b>	<b>MOVE</b>	<b>4</b>	<b>BODY</b>	<b>6</b>	<b>EMP</b>	<b>5</b>
<b>WEAPONS</b>							<b>ARMOR</b>										
<b>HEAVY PISTOL</b>							<b>ROF2</b>	<b>3d6</b>		<b>L ARMORJACK (HEAD)</b>			<b>SP 11</b>				
<b>LIGHT MELEE WEAPON (DIVE KNIFE)</b>							<b>ROF2</b>	<b>1d6</b>		<b>L ARMORJACK (BODY)</b>			<b>SP 11</b>				
<b>SKILL BASES</b>							<p>Athletics 12 • Basic Tech 10 • Brawling 10 • Concentration 12 • Conversation 6 • Deduction 7 • Education 10          Electronics/Security Tech 10 • Endurance 12 • Evasion 10 • First Aid 8 • Handgun 12 • Heavy Weapons 10          Human Perception 8 • Sea Vehicle Tech 13 • Language (English) 14 • Language (Streetslang) 14          Local Expert (Pacific Coast) 15 • Melee Weapon 11 • Perception 10 • Persuasion 12 • Pilot Sea Vehicle 16          Resist Torture/Drugs 12 • Shoulder Arms 10 • Stealth 10 • Weaponstech 9 • Wilderness Survival 9</p>										
<b>GEAR</b>							<p>Heavy Pistol Ammo x16 • Radio Communicator w/ Scrambler/Descrambler • Techtool</p>										
<b>CYBERWARE</b>							<p>Cybereye x2 w/ Chyron, Low-Light/Infrared/UV • Independent Air Supply</p>										

# DRUMMER AND THE WHALE

## DRONES, VEHICLES, AND GEAR

### ► FIFE'S ROV DRONES

Underwater drones in the form of small submarines.

Loadout	Default Trigger	Data
<ul style="list-style-type: none"><li>• Observation Camera</li><li>• Lightweight Manipulator Arm</li></ul>	None. Controlled Directly.	4 MOVE • 30HP Perimeter of Defended Area DV 21 Electronics/Security Tech, 5min to counter.

### ► MACROCHEIRA-CLASS CRABFORM

A giant, enhanced semi-organic guardian. Each one has a conditioned bond with whatever object or location it's given to guard. It recognizes wartime CINO/Arasaka IFF codes and accepts those who broadcast them as allies. The semi-organic nature of the creature prevents Netrunners from altering its behavior. It's possible to locate the RFID/pheromone tag that binds it which is located on the outside of the Cargo Container by making a DV 15 Perception Check. Once an Edgerunner reaches the tag, they can roll a DV 17 Electronics/Security Tech Check to make the Crabform docile.

Loadout	Default Trigger	Data
<ul style="list-style-type: none"><li>• Low-Light/Infrared/UV</li><li>• IFF System</li><li>• Olfactory Boost</li><li>• 2 Very Heavy Melee Weapons (Claws)</li></ul>	Target comes within 4 m/yds of its assigned container without a proper IFF code.	Combat Number 14 6 MOVE • 60HP Perimeter of Defended Area Cannot be countered

### ► MILITECH NASS-54 UNDERWATER DRONES

A semi-autonomous torpedo drone designed for surveillance with a secondary sabotage/defense role. These drones are military gear, controlled by a Balon-Class Demon in the NET Architecture of the SS MacDonnelson. The Demon has a prioritized list of objectives, with direct emergency orders at the top, but can make relatively complex decisions on their execution.

Loadout	Objective Priority List	Data
<ul style="list-style-type: none"><li>• 2 Grenade Launchers</li><li>• Retractable Manipulator Arm w/ a Circular Saw (Very Heavy Melee Weapon) and a Tool Hand</li><li>• Sonar</li><li>• Observation Camera</li></ul>	<ol style="list-style-type: none"><li>1. Follow direct combat commands.</li><li>2. Defend self/allies if attacked.</li><li>3. Follow non-combat directives/mission objectives.</li><li>4. Seek out nearest command/retrieval asset.</li></ol>	Combat Number 14 6 MOVE • 60HP Perimeter of Defended Area DV 21 Electronics/Security Tech, 5min to counter.

# DRUMMER AND THE WHALE

## ► FIFE'S SUBMERSIBLE

This sub probably dates back to the war years. It has full sensors, good comms, and big lighting arrays designed to support a full construction and repair dive team through their day's work underwater. Fife pilots their submersible from outside via the Control Nodes in the Submarine's NET Architecture, while clinging to its hull or swimming nearby. Fife can enter the sub and control it from inside, but vastly prefers to stay in their "native" element.

Upgrades	SDP	Seats	Speed (Combat)	Speed (Narrative)
<ul style="list-style-type: none"> <li>Seating Upgrade x2</li> <li>Manipulator Arms x2</li> <li>Sonar System</li> </ul>	100	8	10 MOVE	15 MPH/24 KPH

## ► MILITECH SSCI GARFISH STEALTH SUBMARINE (SS MacDONNELSON)

A compact military submarine built to direct reconnaissance and incursion. Designed after the 4th Corporate War for quiet, low-intensity conflicts where jurisdiction is a contentious question, the Garfish class trades direct offensive power for invisibility, flexibility, sabotage, and surveillance features. It has a NET Architecture loaded with a Balron-Class Demon to control naval and aerial drones and coordinated commando teams to recover agents in enemy territory. The Garfish has 3 full-size torpedo tubes (use **Onboard Rocket Launcher, CP:R PAGE 164**).

Upgrades	SDP	Seats	Speed (Combat)	Speed (Narrative)
<ul style="list-style-type: none"> <li>Armored Chassis (SP 13)</li> <li>Communications Center</li> <li>Heavy Chassis Upgrade</li> <li>Onboard Torpedo Launcher x3</li> <li>Militech Growler</li> <li>Security Upgrade</li> </ul>	200	16	20 MOVE	60 MPH/97 KPH

## ► MILITECH GROWLER

**Cost:** 10,000eb (Super Luxury)

This experimental weapon represents the latest in Militech crowd control technology and is being field tested by the SS MacDonnelson.

*An Exotic Rocket Launcher that forces any creature in the area of its blast with an organic brain to make a DV 19 Resist Torture/Drugs Check or suffer the Brain Injury Critical Injury (SEE CP:R PAGE 221). Reloading this weapon requires 2 Actions, and thus can only be done over the course of 2 Turns. Firing this weapon requires BODY 11 or higher unless it is mounted.*

# PR0T0C0N

{live in c0ncert //  
One night 0nly //  
night city plaza}

Torrell and Chiang

*Elegance in  
Every Stitch*



*Whether we are tailoring  
an existing garment or  
crafting something  
brand new we will do so  
with an expert eye,  
a clever hand, and  
an elegant heart.*

# MindOutz

L♥VER



SOUTH NIGHT CITY'S HOTTEST BRAINDANCE CLUB

**FEATURING DJ FRAME!**



# HAVEN'T GOT A STITCH TO WEAR

## BACKGROUND (READ ALOUD)

Night City has taken a number of nasty blows over the years but even during the Time of the Red life goes on. And as traditional supply chains continue to be fractured and unreliable, the inhabitants of the city turn to new... alternative... economies to get what they need. Even when what they need is as simple as a damn good suit. You've all been summoned to one of the buildings that still stand in Westhill Gardens, out where exclusive tailors Torrell and Chiang do most of their actual work. You're all here because one of the tailors working for Torrell and Chiang needs some expert troubleshooters. They put the word out to local Fixers, who brought in you.

## THE REST OF THE STORY

The Torrell and Chiang's fortunes have been on a recent upswing as the demand for bespoke tailored high fashion has risen. But that leaves the small business scrambling to find suitably qualified labor – trained bespoke tailors don't just grow on trees or pop out of the vats at Biotechnica. In an effort to delegate their skilled labor where it's needed most, the shop's management have been farming out simple

repairs and alterations to piece-work stitchers located all over the city. The suits are packaged neatly in poly dry-cleaner bags, shipped out via couriers, and then shipped back once the work is complete for customers to collect. The logistical coordination is handled through Ms. Mynah, a specialist Fixer who has her fingertips on the pulse of Night City's informal labor market, and the deliveries are done largely through Fixie's anarchist bicycle couriers.

However, unbeknownst to the tailors at Torrell and Chiang's, Fixie's is currently struggling with a hostile takeover from Lightning Logistics, an enterprising group of Edgerunners who think they can make the couriers more efficient. Lightning Logistics has taken over the *Rambling Rose*, the Fixie's HQ, at gunpoint. But things are not going well for the new bosses, with few parcels reaching their intended destination. Which, in turn, has led to a virtual standstill of Night City's informal courier post. And left the tailors at Torrell and Chiang in a real pickle. Some of the suits waiting to be delivered are for customers with pressing engagements: black-tie weddings, opera premieres, and high-powered board meetings. That's where the Crew comes in.

## THE SETTING

The story begins in the charming manufacturing headquarters of famed tailors Torrell and Chiang's before moving to an abandoned mall turned perpetual Night Market in Rancho Coronado. From there, the Crew heads to the Heywood Industrial Zone and boards the D.V. *Rambling Rose*, once a ship in drydock and now home to a thriving courier network.

## THE OPPOSITION

- **Angry Customers**, largely civilians with side-arms lining up outside of Ms. Mynah's consulting offices to complain about their missing packages.
- **Muscle** hired by Lightning Logistics will be patrolling the streets leading to Fixie's distribution center and HQ, but many of them can be evaded with stealth or cleverness.
- **Lightning Logistics**, a group of Edgerunners led by **ConEx**, an Exec looking to make a name.

SEE PAGE 88 FOR STAT BLOCKS



BY JEFFREY MCDONALD

# HAVEN'T GOT A STITCH TO WEAR

## THE HOOK

The front door of Torrell and Chiang's is discreetly armored and armed with a basic security setup — just a sensible precaution in Night City — and the Crew is buzzed in once confirmation of their identities has been made visually and verbally via intercom. The heavy door swings open to admit them, and then locks behind them with a secure thump, before they're met in the hallway by a short, androgynous figure with blue-green hair and soda-bottle glasses.

That person is Shears, the tailor at Torrell and Chiang's who has put out the troubleshooting request with local Fixers. Shears welcomes the Crew into the kitchen and dining area of the house, which serves as a break room for the tailors who work here. The furniture in the house is utilitarian and well-worn, interspersed with sewing equipment and storage for bolts upon bolts of expensive fabrics. There's a constant low-grade hiss and thrum from the tailors within operating the steam presses and industrial sewing machines, and the repeated staccato impacts of someone driving a chisel through a coat front to open up the layers of wool and canvas for buttonholes.

"Welcome to Torrell and Chiang's manufacturing center, it's where we actually make the suits, since some of our equipment isn't very portable. I hope the neighborhood security watch hasn't given you any trouble? But where are my manners? Come over to the kitchen and make yourselves comfortable. I've got some Coco Kibble cookies out, and we've got synthcoffee and herbal tea if you'd like some."

Shears takes pains to ensure that the Edgerunners are comfortably ensconced at the table with a beverage and a snack before taking a seat themselves. A DV 13 Basic Tech Check reveals to any tech-savvy Edgerunners that Shears' eyewear is a stylized pair of Smart Glasses. Shears is a slight, well-dressed person of East Asian ancestry, with dyed blue-green hair.

Today they're wearing a crisp pinstripe dress shirt with a vivid silk tie tucked down the front of their light gray wool waistcoat, with matching trousers and oxblood-colored cordovan dress shoes. Their hands, in contrast to their polished attire, are a little chapped, with occasional bitten-off hangnails. They carry a pair of shiny tailor's shears in a fancy, hand-tooled synthleather holster on their right hip, and have a tape measure draped around their slight shoulders.

BY NEIL BRANQUINHO



Shears

"Let's get to business, then. We've seen a steady increase in demand over the past few months, and frankly we've been having trouble meeting that demand. We've been facing something of a labor bottleneck. Tailors skilled enough to turn out a bespoke suit are a rare commodity indeed. In times like these, we reserve our own tailoring person-hours to the parts of a suit requiring our expert touch—the canvases, which we pad-stitch by hand, the finishing work and the cutting-draping work. Almost everything else, repairs, alterations and miscellaneous assembly is farmed out to freelance piece-work stitchers across the city, paid by the piece. I sent several suits that needed alterations—mostly letting out or taking in coats and trousers, things like that—out sixteen days ago, all of which should have arrived back here two days ago. They have not. Some of those suits are for clients with pressing engagements and finite patience. I've called them to explain the extenuating circumstances and offer to replace missing suits with brand new ones if necessary, but we don't have the capacity to produce near a dozen bespoke suits in two days. So I need you

## THE RC NIGHT MARKET

The RC Night Market isn't a single venture but dozens of them, each put together by various Fixers working in cooperation with one another. The one thing they have in common is their location—they all take place in Minimalism, a once trendy but now abandoned shopping plaza located in the heart of Rancho Coronado. The multiple Night Markets setting up, often concurrently, in this one location provides the illusion of an ongoing bazaar instead of dozens of individual operations. The biggest constant is Ms. Mynah, who keeps an office in the abandoned shopping plaza for the sake of consistency.

*all to run an errand. Bring the package of suits back undamaged within the next three days, and I'll pay you a cool 500eb each, and throw in a free suit custom tailored for one of you. To collect said package, You'll need a copy of the waybill the Fixer gave me when I turned the suits over to her, and her card. She works out of a Night Market in Rancho Coronado."*

When quizzed about the job, Shears has these answers to give.

### ▶ WHY HIRE EDGERUNNERS?

*"Why would I need a crew of Edgerunners to run a simple errand like this? Simple answer. Torrell and Chiang suits are worth about five thousand eb apiece. There's eleven suits in the package. More than fifty thousand eb worth of bespoke clothing is a lot of potential money to be playing around with even if the suits wouldn't fit a person they weren't made for."*

### ▶ WILL THIS BE A DANGEROUS JOB?

*"Do I expect violence? I hope not. I'm not a very violent person myself, even if I spend my workday surrounded by sharp pointy things. Still... there is the not-untrue joke that some Execs would kill for a Torrell and Chiang suit."*

### ▶ WHO ARE YOUR CLIENTS?

*"No. I can't name them. We guarantee confidentiality. Although I'm sure any one of you with a discerning eye could guess quite easily who in Night City is wearing one of our suits, just from how beautifully it fits them." Recognizing a Torrell and Chiang suit requires a DV 13 Wardrobe and Style Check.*

Briefing over, Shears escorts the Crew gently out of the manufacturing workshop, pressing several items into their hands on the way out. First is a 100eb per Edgerunner, for operating expenses. This is above and beyond the promised 500eb

per Crew member, because Shears is a generous soul. There's also a photocopy of a waybill noting delivery from Torrell and Chiang's workshop to the RC Night Market.

"Look for Ms. Mynah," Shears tells them, handing them a thin translucent plastic name card. Holograms built into the card gleam and reflect the image of a black-feathered tropical bird, along with an Agent-readable code that brings one to the Garden Patch of the Fixer herself.

"Ms. Mynah," the card reads. "Labor and Logistics Consultant."

Lastly, Shears hands them a paper bag with a packed lunch and a half-dozen bottles of Cactus Water to eat on the road. It's easy to get a feeling Shears has managed to retain the talent working for them by feeding them until they lose the ability or desire to run away. The packed lunch consists of simple homemade sandwiches wrapped in waxed paper—soy cheese and SCOP on kibble loaf with a delicious scrape of simulated wild crabapple chutney, but it's free.

"Keep me updated as you go," Shears says as they see the Crew out of the door. "You can always call me on my Agent, I'll keep the earpiece in all day."

## GO TO DEV (THE NIGHT MARKET)

## DEV (THE NIGHT MARKET)

With this the Crew are left to make the journey to the RC Night Market, which is run out of a reclaimed and refurbished mall. They can get there via their own transport, but the Night City Transit Corporation runs buses across the bridge on a regular basis.

On arrival the Crew finds a long line of grumbling customers wending through various stands of the Night Market. A DV 13 Perception or Deduction Check lets the Crew notice that some of the stands are left

# HAVEN'T GOT A STITCH TO WEAR

empty, despite being open for business, allowing them to deduce that the disgruntled customers are in fact other Night Market vendors.

The line leads all the way through the stalls to Ms. Mynah's small makeshift office, where the Fixer herself is fending off the latest group of angry customers. Edgerunners with amplified hearing who pass a DV 13 Perception Check or anyone who makes a DV 15 Lip Reading Check can catch the following snatches of conversation.

*"Red, I know it's difficult—nobody expected the most reliable couriers in Night City to suddenly stop delivering. It's a matter of extenuating circumstances."*

*"I don't care about your 'extenuating circumstances,' Mynah! Your shipping screw-up has cost me money, and it's about to ruin me, unless you can come up with some kind of compensation."*

The two speakers are Ms. Mynah, a well-dressed, young Fixer with an Exotic biosculpt, and a squat, broad man who looks like a vertically compressed human refrigerator. The man is dressed in a well-worn flannel shirt and faded jeans, and his fingers are lingering impatiently on the synthleather holster he wears on his hip—one that holds a Very Heavy Pistol. The woman, whose hair and eyebrows have been replaced with gleaming black feathers, is beginning to rise from her chair, her gaze fixed on the man's bulky sidearm.

## GO TO CLIFF (BIRD IN TROUBLE)

### CLIFF (BIRD IN TROUBLE)

It does not take a genius in Tactics to realize that Red (use **Road Ganger**, **PAGE 173**; remove Crossbow, add Reputation 1), the man currently confronting Ms. Mynah, is about to resort to physical violence. Edgerunners may use various means to defuse the situation. For example, a well-known or particularly violent Edgerunner could make a Facedown to intimidate Red into quiescence, or a fast-talking Edgerunner could use Persuasion or another Social Skill (DV 15) to deescalate the situation instead. Don't forget the Complimentary Skill Check rule (**SEE CP:R PAGE 130**). With it, Edgerunners not on point in the scene can still help out!



BY BAD MOON ART STUDIO

If the Crew does not succeed at defusing the situation, then Red lunges for Ms. Mynah. If the Crew objects to this, a fight breaks out and Red is joined by a number of compatriots (use **Boosterganger**, **PAGE 172**) equal to one half the number of Edgerunners present (rounded down) plus one. Anyone in Red's gang, including Red, gives up and surrenders if they lose 5 or more HP. These are people who have lost their tempers, not cold-blooded killers. Edgerunners who push the point further may develop a negative Reputation. If the Crew is about to lose due to bad rolls, feel free to have the Night Market's own security intervene to nip the fight in the bud before it gets too rough, since it would be anticlimactic to have them wiped out before they even reach the middle of the mission.

After the dust settles, or if the fight is averted through charm, intimidation, or other quick-witted means, the line disperses, with various vendors returning to their stands while Red and his buddies are swiftly ejected from the premises. Ms. Mynah thanks the Crew for their intervention.

## GO TO DEV (MS. MYNAH'S PROBLEM)

# HAVEN'T GOT A STITCH TO WEAR

## DEV (MS. MYNAH'S PROBLEM)

*"Thank you for heading that off. I'm not sure where I would be if you hadn't nipped that in the bud. That's the last time I send my bodyguard out for lunch."*

Ms. Mynah is shaky, clearly inexperienced at the nastier end of Night City wheeling-and-dealing. When presented with Shears' waybill for the missing suits, she only sighs heavily and sits back down at her desk.

*"This really is Fixie's problem, but because Fixie's delivers so much in Night City, their problems become everyone's problems."*

Edgerunners may make a DV 13 Business or Streetwise Check to realize what Ms. Mynah is talking about, and she launches an explanation if nobody makes the roll. Fixie's is a courier network local to Night City, where freelance couriers deliver packages all over town for the right fee. All of Fixie's couriers wear a reflective cap and armband as part of their livery,

and hold to strict rules of neutrality so that they can generally deliver goods unmolested even in Combat Zones. Only the most dorphed out or most discreet of gangers would try to waylay a Fixie's courier, because of how important their services are to the supply chain in Night City. Any courier breaking the neutrality rules while in Fixie's livery is swiftly punished and blacklisted, never to work for the business again, which is how they get through the rougher parts of Night City without so much as a scratch.

However, something has clearly happened to Fixie's, because almost all their packages have failed to arrive in the last 24 hours. That is both highly unusual and catastrophic for most of Night City's street vendors and Night Markets for obvious reasons. Goods have to circulate in order to reach the hands of customers.

*"You really should talk to Fixie,"* Ms. Mynah says, referring to the semi-legendary organizer of the couriers network, *"Except she hasn't been taking calls, not even from me, which means things are bad."*

If asked why she would know that, Ms. Mynah replies with, *"I'm not an ordinary business partner. Our fathers are cousins, and our grandfathers were from the same village in India. It's... hard to explain. But couriering and logistics is in our blood."*

Ms. Mynah directs the Crew to the Fixie's clearing-house in the Heywood Industrial Zone.

*"Look for the D.V. Rambling Rose. D.V. is old shipper speak for 'Dead Vessel', which she is—the old feeder ship, I mean. A rusted hulk that's no longer fit to go out to sea. Some squatters filled the damaged drydock she was moored in with rubble, then filled the gaps with concrete and compost and converted her into a mixed-use building. The couriers took the space over as an HQ a few years back because they needed a shipping hub for their goods."*

On the way out of the Night Market, the Crew is approached by various stallholders who do not have weapons drawn. In fact, they seem worried and conciliatory, and would like to hold a friendly chat. They offer the Crew additional rewards for sorting out what's going on at Fixie's, because so much of their business logistics rely on the couriers and their neutrality.



Ms. Mynah

BY SEBASTIAN SZAND

# HAVEN'T GOT A STITCH TO WEAR

Roll 1d10 (or choose, if you prefer) for each member of the Crew, and refer to the Vendors at the RC Night Market table, rerolling duplicate results. These are the additional rewards offered to the Crew on successful completion of their troubleshooting job. Of course, the Edgerunners can also do a little shopping before they leave, if they like.

## ▶ VENDORS AT THE RC NIGHT MARKET

1d10	Vendor
1	The <b>Chicken Lady</b> , a messy-haired older woman wearing a chicken hat. She will reward the Edgerunner for helping her with the gift of two pullets, healthy and ready to lay. The chickens are worth 50eb each. She will also throw in a basic coop for cost price (50eb) if the Edgerunner wants to house and feed the hens to supplement their food. The birds can be fed on leftover kibble crumbs.
2	<b>Spooky Sue</b> , a stringy-haired, white-gowned street chemist who looks like she crawled out of an old tube television in a J-horror flick. She will whip up a batch of street drugs for the Edgerunner, value up to 100eb. Spooky Sue cooks it all up, and is noted to turn out clean, high-purity stuff.
3	<b>Auntie Ivy</b> , a tough, flannel-wearing middle-aged woman with a green polymer prosthetic thumb. She's a member of the Dirty Hippies and is therefore a hydroponics expert. If the Edgerunner succeeds, she will reward them with excess produce—enough to make up the equivalent of 100eb of Freshpak meals.
4	<b>Vesper</b> , a gender-neutral street tattoo artist and qualified cosmetic ripperdoc. Vesper will perform a custom Light Tattoo commission as a reward for the Crew sorting out the shipping problem. They are also down to do a traditional tattoo instead for a change.
5	<b>Delphine</b> , a neo-hippie street psychic. Delphine's reward is slightly esoteric. After the Crew return from the Industrial Zone she will perform a Tarot reading for one of them, and the advice she gives can be an interesting way for you to foreshadow future missions.
6	<b>Samuelson's Locks</b> are a group of locksmiths who usually sell security to their customers. Most of their locks are hard to pick or otherwise circumvent. However, as a favor to helpful Edgerunners, Samuelson himself will pick one lock for them—any lock—provided that he doesn't have to leave the premises of his store to help them. He isn't interested in endangering his life to pick a physical lock surrounded by hostiles.
7	<b>Suzuki's General Goods</b> is a mobile bodega, with useful goods for anyone who prefers Japanese-American cuisine. Most of the rewards Mr. Suzuki could offer aren't going to interest Edgerunners much, but Mr. Suzuki's niece Mio is a budding Rockerboy with a band made up of adorable middle-schoolers who will write and release a song about how awesome the Crew is.
8	<b>Richard's Reminders</b> is an outlet store selling clearance items from Vendits. He will reward an Edgerunner with a large crate stuffed with 5 Vendit items of the GM's choice.
9	<b>Coronado Ceramics</b> is an independent ceramics studio that sells their wares at various Night Markets. They make an attractive variety of hand-thrown and hand-glazed ceramics decorated with the leavings of Night City life. Their wares are decorated with broken windshield glass, melted down circuit board gilding, and bone ash glaze. Their proprietor is one Sandy Sheldon, a woman of mixed ancestry with a deep, husky voice. As a favor to an Edgerunner she will repurpose their sizable ceramic kilns one time to dispose of a body, no questions asked. She will also throw in a set of matching coffee mugs.
10	<b>Myrtle's Mini-Livestock</b> is a strange shop run by a strange, tiny blue-haired old lady named Myrtle. Myrtle is also a PhD in entomology, and she ranches bugs for protein. As a reward, Myrtle will provide the Edgerunner with two ant farms in large mason jars. Those ant farms seem useless until Myrtle informs them that the ants in the jars are nasty stinging species, and that the ants will swarm angrily forth upon whomever the jars are broken upon... happy jar-flinging, choombas. Treat them as grenades that do no real damage, but will temporarily disfigure targets with swollen ant bites, giving them a -2 to any Personal Grooming Skill Checks for one week.

GO TO CLIFF (BLOCKADE)

## ABOUT THE ROADBLOCK

If the couriers seem nervous, it isn't just because they're worried about their business. The biggest dog in the Heywood Industrial Zone is Zhirafa (SEE CP:R PAGE 281), who controls a large campus of factories and offices not too far away. Setting up roadblocks, even if only around the D.V. Rambling Rose, risks calling down their wrath if it goes on for too long.

## CLIFF (BLOCKADE)

The rusting mass of the *D.V. Rambling Rose* is quite well-hidden among the warehouses, workshops, and tenements of the Heywood Industrial Zone. During the Time of the Red, squatters moved in and used some of the still-functioning industrial cranes to stack empty shipping containers into rough apartment blocks accessed initially by ladders, and then followed by open-air walkways and stairwells fenced off by reclaimed wrought rebar.

A lot of the metalwork in those makeshift apartments is covered with bright automotive enamel paint to protect it from the salt air of the bay.

Roughly a block away from the *Rambling Rose*, the Crew is challenged by a roadblock. Manning the roadblock are a few of Fixie's couriers, all wearing the distinctive reflective cap and armband livery of the gang. They are all carrying their weapons at low ready, but do not bring them to bear as the Crew comes into view.

"Sorry," one of the couriers says through a loudspeaker, "please slow down, thank you, there's something going on and we're asking everyone to detour around the area."

The Edgerunners are advised to slow down and speak to the blockade-running courier, at least. The roadblock is essentially a board nailed to a pair of sawhorses and won't do much to stop a driver determined to go through—nor will any of the couriers actually fire a shot to stop them, since they're there mostly to warn people.

If the Crew does slow to a stop, they are advised thus: "I'm sorry, but this part of the Heywood Industrial Zone is not safe. We can't stop any of you from going in, but we'd at least want to warn you what you're going to face in there. We're not the boss of you or anything."

On further inquiry from the Crew, the courier with the loudspeaker approaches their vehicle to explain the situation.

"About 48 hours ago we were the target of a hostile takeover, violating our neutrality in Night City. Some gang or other has locked down our HQ and distribution center, and we're trying to keep the situation contained so nobody else gets hurt. They've been content to sit tight in the D.V., but while she's locked down no deliveries are going out, and goods can't come in. Sorry."

If the Edgerunners flash Ms. Mynah and Shears' documentation, the courier will step back and murmur to a colleague, who then radios back to someone.

If the Crew decides not to speak about their mission, the couriers instead receive a radio message, and one of the couriers calls out to the one speaking to the Edgerunners.

Either way, the end result is the same. There's a rapid flicker of silent hand signs, and then the courier leans in again.

"My boss, Fixie, would like to invite you all for some soy chai, and talk to you about the current situation before you head further in, if you please."

The Crew is free to accept this offer or not. If they refuse to stay and just go further in, then the couriers haul the roadblock aside and let them pass. In that case, **GO TO CLIFF (ROSEWARD)**.

If they accept, however, they're pointed to some parking space by a block of shipping container apartments, with a large awning set up across one of the ground-floor spaces.

## GO TO DEV (MEETING FIXIE)

## DEV (MEETING FIXIE)

A group of couriers are gathered around a large folding table, updating a paperfax map of the area around the *Rambling Rose*

# HAVEN'T GOT A STITCH TO WEAR

with poker chips and hex nuts representing unknown forces. A tall, dark-skinned woman of South Asian descent is standing, arms folded, at the head of the table, and she looks up, unsmiling, at the Crew as they enter. She is wiry as a distance runner tends to be, with little curve on her angular frame. What muscle she has is more compact from frequent cycling and running as opposed to the bulk put on by lifting heavy burdens, and her long black hair is pulled neatly in a braid that hangs down her back.

*"Ah. Welcome. I'm sorry I have so little hospitality to offer you, but we've been locked out of our home for the past two days. Still, please, take a seat, I'll have some chai poured." One of the other couriers serves you all tall glasses of hot soy chai made largely of wild raspberry leaves, spiked with synthetic caffeine and ersatz spices, but it's still a hot, sweet drink against the cooling air of the evening.*

*"I am Fixie," the woman says, "and I'm the leader of the couriers... well, as much as we have a 'leader.' We're all a bit anti-system here. I organize what little will be organized among us, so you might say I keep the tracking moving. Which no longer moves. No doubt, you will have been informed that we've become the targets of a hostile takeover."*

Fixie takes up her own glass of chai and takes a long sip, then sighs. *"Honestly, I would be glad to leave whoever's taken over the Rose to the business and let them handle the deliveries, except they're not delivering. I'm not exactly sure what they want. All we do is get things to where they're needed. It's our niche, and every economy needs someone to smooth the logistics along. My own great-grandfather spent his whole life delivering lunch boxes from one end of Mumbai to another."*

An Edgerunner who makes a Business or Education (DV 15) Check will have heard of the dabbawalas of Mumbai, lunch couriers who are legendary for their accuracy despite having devised their logistics systems before computers were in common use. They have been estimated to make less than one mistake every sixteen million deliveries, using a series of color-coded markings to determine the origin of a given lunch box, the train station it is taken to, the train station it is unloaded from, and then the end address it is meant to be delivered to.

BY NEIL BRANQUINHO



Fixie

The Crew might have questions for Fixie, after she has finished her statement. These are her answers.

## ► WHY HAVEN'T YOU TAKEN YOUR HQ BACK?

*"Well, most of us aren't fighters. Besides, we fight only in defense of life. Property isn't worth killing for. Mostly. I admit I made a mistake and allowed us to become too centralized... when I started out, whenever someone threatened us we'd just move from one temporary HQ to another. But the business has gotten too big to move, and we don't really have the time right now to organize another meeting to determine if we're going to take up arms or not."*

## ► DO YOU KNOW WHY DELIVERIES STOPPED?

*"I have some idea, yes. We may be anarchists, but we're not completely stupid. I suspect they've bitten off rather more than they can chew—an outsider isn't going to make any sense of our own logistics setup since I based it off my own grandfather's experience as a dabbawala before he came to America."*

## ► WHY DON'T YOU JUST GIVE UP?

"Would I be willing to abandon my life's work so lightly? The way I see it, if they can take over our business and run it better than I can, then they're welcome to it, and I could stand to learn some things from them. But this is not a takeover, they're just locking themselves in the toilet and not taking a shit, pardon my crudity."

## ► WHY DID YOU BLOCK OFF THE RAMBLING ROSE?

"For everyone's safety. The gang muscle our opponents are relying on are ill-disciplined and squeeze off shots the moment they see someone they don't know—which could mean an innocent getting hurt. You're professionals, of course, and I'm sure you could handle this well."

## ► HAS ANYONE TRIED GOING IN?

"Yes, actually. There was a man who was bent on finding one of the shipments there. He said his favorite suit was in it and he had an engagement to keep in the coming days. I thought him suicidal, but he seemed competent. My scouts haven't heard any gunfire, so he could still be in there. And alive."

Once the Crew's curiosity has been satisfied, Fixie will order a refill of everyone's chai, and begin explaining the situation.

"There's two tiers to Lightning Logistics, the organization that took us over. It's made up of a core of capable Edgerunners. The rest is crude muscle imported from SoCal. Most of the people in Night City know better than to interfere with our business—anyone who tries to disrupt our couriers stops getting deliveries, for good. It makes life a good deal harder in the long run. As to who the leadership of this group is... well."

Fixie slides over a photograph of a sharp-looking man in typical Corporate gear, an off-rack suit and some flashy Smart Glasses. The smug smile on his face is visible even through the telephoto zoom on the image.

"That's Harry Deput. We were... acquaintances." The look on her face hints that they were rather more than just acquaintances. "He has always been very much interested in backing my business for a share of the dividends, without actually realizing that we aren't a business. We're closer to a union or a guild. I think he wants to modernize the couriers... but he's not going

to be able to do that if he doesn't even understand how we do things in the first place. We parted ways somewhat bitterly after I told him what I had just told you, which is probably why he's decided to prove that he can do this better than I can. He's put together a group of freelancers, probably promising to pay them from the profits everyone stands to make after they streamline the couriers and cut the fat."

With that, Fixie uploads maps of the *Rambling Rose* to the Crew's Agents and lets them go. She murmurs some orders to her couriers over the radio, requesting that they let the Crew into the perimeter they've established.

## GO TO CLIFF (ROSEWARD)

### CLIFF (ROSEWARD)

The warren of dead-end roads and alleyways that have sprung up around the *Rambling Rose* are patrolled indifferently by the mooks (use **Boosterganger, PAGE 172**) in Lightning Logistics' employ. They are loud and obtrusive, relying on their guns to keep noncombatants cowed. Armed combatants such as the Crew will soon find themselves challenged if they venture openly, and while line of sight is hard to establish in the lanes, clever Edgerunners could make use of the outdoor stairwells welded to the shipping-container apartment blocks to snipe and ambush.

The Crew can attempt to stealth their way through but the mooks control key passageways and at some point, there should be a confrontation of some sort.

When the confrontation begins, the opposing group of mooks has a number of members equal the Crew's own head count. Feel free to subtract forces if the Crew is not combat-focused, and add more opponents if they are in fact a well-tuned cyberpunk killing machine.

There are frightened civilians hiding out in their locked homes, so grenades and other armaments that induce large amounts of collateral damage may be contraindicated, if the Edgerunners care.

If they do not care, the mission proceeds as normal, except that they may receive a reputation for being bloodthirsty. The mooks themselves are under no real constraint and will very much make a big noise and mess unless handled stealthily.

## HAVEN'T GOT A STITCH TO WEAR

During the confrontation, have the Edgerunners make a DV 15 Perception Check to realize that they are being watched as the combat unfolds. Someone has taken up a perch from a nearby building and is observing the fight.

As the fight goes sideways for them, have the mooks call in reinforcements. Another group, equal to half the size of the original, begins filing in. Just as those reinforcements file into the alleyway, a long-range shot rings out from a nearby apartment, aiming for the boostergangers, and not the friendlies. A message blips briefly on the Crew's Agents, sent out on an indiscriminate short-range blurt.

*Friendly. Don't wanna scare you.*

The friendly shooting at the mooks is the Tech/Solo John Doe (SEE PAGE 90), who has in fact gone into the cordoned off area alone to find his favorite suit. If the Edgerunners stopped to talk to Fixie, they might know that there was someone else in there with them. If they didn't, this is a good time for him to introduce himself.

Mopping up those reinforcements should be trivial with John's assistance. When the fighting is over the Crew receives another message on their Agents

*Into the alley with the burned-out cars. Coming down.*

As they enter the alley, a figure descends rapidly, rappelling from the open window of one of the apartments above. They land in the alleyway by the Crew, and put their hands up in peace. Said figure is the Tech and Solo John Doe, who is wearing an immaculate armored Torrell and Chiang three-piece suit. His long blond hair is pulled into a tidy manbun, and he flashes everyone a calm, assessing glance as he puts his hands slowly down. He's fairly tall at 1.8m (6ft) but not unusually so, and he's built like a dancer, slender enough that the Edgerunners can imagine Shears carefully tapering his trouser legs to highlight the curves of his calves. His lush silk necktie is covered in tiny paisley motifs that look a little like amoebas.

*"You're not gangers," he says, "so you must be troubleshooters coming in from outside to sort out this situation. Unless it's a hostile takeover of another hostile takeover?"*

John Doe is armed with an Assault Rifle but he's clearly not intending violence. Not at them, anyway.



BY SEBASTIAN SZMYD

## GIVING YOU CONTROL

We haven't listed out specific guard patrol routes or encounters in the area around and aboard the *Rambling Rose* for a reason. As GM, it is up to you to decide how many encounters you want to throw at the Crew and how dangerous those encounters are. If you want a shorter session or don't want a lot of combat focus, make patrols and potential ambushes sparse. If you want the Crew to feel as if they're inching their way through enemy territory, make them frequent but give the Crew chances to set up their own ambushes and use clever tactics. Customize this part of the mission to suit your table.

If asked if he was the man Fixie was referring to, who was looking for his favorite suit: *"Yes, that was me. I have um. A hot date this coming weekend and that's my favorite suit. Chocolate-brown English flannel, vintage pre-War fabric, with a violet and gold Bemberg lining. I was having it repaired after it sprouted a couple bullet holes. You know how the business goes."*

If someone notes this is just some clothing, he repeats, *"It's my favorite suit."* This is said with the calm of someone who expects his explanation to make sense even if it does not.

On why he helped the Crew during the gunfight. *"The enemy of my enemy, right? I mean, it's no skin off my nose who you work for, as long as I get my suit back... and there's probably a few other suits from the tailor's there, if I know how Shears works. I'd love to get those back for Shears if you're not interested in them, but I'm not going to interfere as long as I get my own suit back first and foremost."*

And on whether he can vouch for his skills. *"I'm sorry, but if I told you, I'd have to kill you."* This said with the faintest hint of a gentle smile.

Impertinent Edgerunners may ask him about his "hot date." At which point he actually blushes a little, and says, *"No comment."*

All this is delivered in a general tone of dissonant serenity, as though there really isn't anything that can shock him. He's unperturbed but not unfriendly. A DV 13 Streetwise Check will confirm his reputation to Edgerunners who are in on the gossip—that John Doe seemed to have sprung up fully grown on the Night City Edgerunner scene three or four years ago. His reputation is that of a consummate professional, someone who probably was in the spook business for Uncle Sam or some other national government before he went

freelance. His specialties are black-bag and surveillance work, but he's a capable combatant in a firefight as well.

A DV 13 Perception Check brings to an Edgerunner's notice a small enamel Elfines Online pin gleaming on the flap of his backpack, which brings an additional bit of gossip to mind—rumor has it that he likes to hack his Segotari headset and multi-box four elves in a synchronized group so he can solo group content.

The Crew is free to take John Doe along with them, or not. If they do accept him into their group, he will tag along as the rear-guard. Increase the number of opponents facing the Crew in coming fights to balance the additional firepower he provides the team.

If they turn his offer down, he tips them a casual salute. *"Try not to get killed, huh? I'll see you deeper in."* With that, he will move on.

If the Crew opens fire or are otherwise hostile, he will defend himself only long enough to get away. The noise will certainly attract additional hostiles in the form of Lightning Logistics' mooks.

## GO TO DEV (THE RAMBLING ROSE)

## DEV (THE RAMBLING ROSE)

The D.V. *Rambling Rose* is very much as Fixie described it—it's a ship (classified as a small feeder, rather than a full-size container ship) that was abandoned in its dry dock after the nuke, and then was stabilized and re-purposed as housing and an operational headquarters for the commune that would eventually make up Fixie's couriers. As a small-sized container ship, the *Rose* is 100 m/yds long and 16 m/yds wide and scouring her would take days, if not a week. Given the unique system used to organize storage and deliveries, the best way to find the suits is to return control of the *Rambling Rose* to Fixie.

# HAVEN'T GOT A STITCH TO WEAR

If the Crew talked to Fixie, she'll have uploaded maps of the *Rose* to their Agents. If they did not, then they will have to do this blind. If a Netrunner is in the Crew, they can hack into the *Rose's* NET Architecture (SEE PAGE 88) to find maps of the ship's layout and utilize the ship's surveillance systems to spot potential ambushes.

Most of the infiltration can be done as a stealth mission if the team's makeup allows for it—Stealth Checks of the appropriate DV can be substituted for combat Checks, allowing Edgerunners to evade fighting. The GM should therefore vary the number of remaining encounters in the *Rambling Rose*, gauging according to Crew's strength and their remaining reserves and resources.

Having John Doe with the Crew will help, as he's an expert on surveillance and can sneak ahead in order to check for ambushes. If John Doe is not in the group but still on fairly friendly terms, the GM may roll 1d10 every time the Edgerunners are about to head into a dangerous situation. On a 10, John Doe will update

them with a warning on their Agents before they come into sight of the security using short phrases like "Watch out!" or "Gangers up ahead!"

If John Doe is hostile after the Crew opened fire on him, they will find the trek into the *Rambling Rose* rather more difficult, as John Doe will have gone ahead and made a deal with Lightning Logistics and warned them of the Crew's approach, in exchange for the box of suits. He will opt to sit the rest of the combat out and is in fact on his way out of the Heywood Industrial Zone. Increase the number of mooks the Crew faces in any encounter by 2.

Once the Crew reaches the command center, **GO TO CLIMAX (LIGHTNING LOGISTICS)**.

## CLIMAX (LIGHTNING LOGISTICS)

There is a command center built into the altered structure of the *D.V. Rambling Rose* from which Fixie used to organize the shipments of goods into the rest of Night City proper. This is where the new owners of the ship

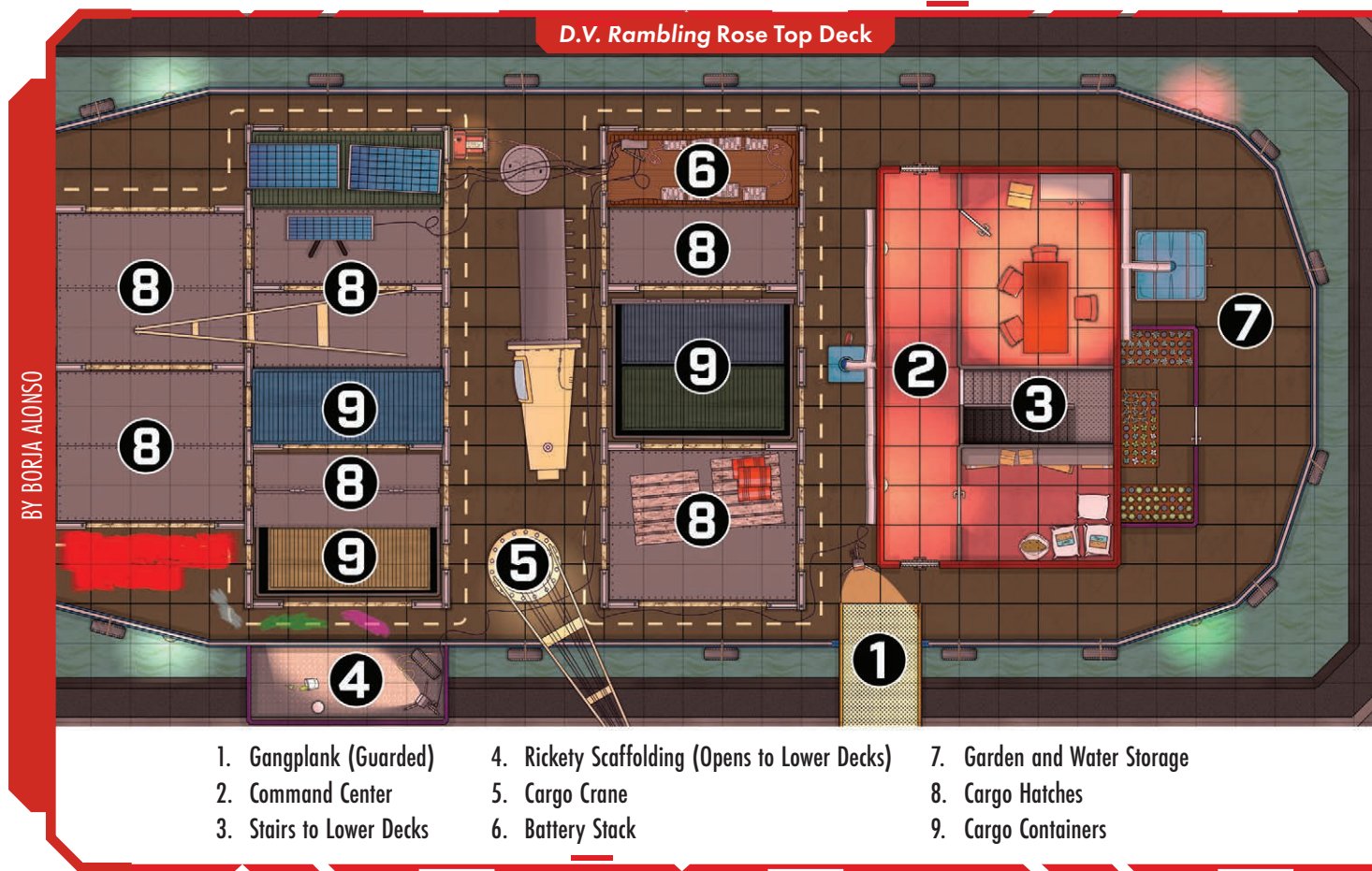

# HAVEN'T GOT A STITCH TO WEAR

have holed up, attempting to make sense of Fixie's idiosyncratic documentation while they try to consolidate control over the surrounding area.

Sitting at the scratched desk in the back of the room is Harry Depuy (aka ConEx, for Continental Express, a shipping company he used to work at, **SEE PAGE 88**). Depuy may be familiar to the Crew if they sat down to talk with Fixie earlier. He looks a little less together and a lot less smarmy than he does in the photograph they were shown. This is largely because he looks stressed and harried instead.

Backing him up are several other Edgerunners—his crew, as it were, consisting of Sugarplum, a Netrunner (**SEE PAGE 89**), Boom-Boom, a Tech (**SEE PAGE 90**), and 512, a Solo (**SEE PAGE 88**). Additional muscle, in the form of mooks, can be present if the Crew's numbers are superior or the GM feels they need more of a challenge. Wheels, ConEx's driver, isn't present.

The command center is less a room proper and more a cavernous holding area for boxes and boxes and boxes of stuff—all labeled neatly with recipient name and address. There are dollies and pallets used to organize and move shipments, and a pair of well-maintained forklifts and lifter exoskeletons are propped in charging cradles, idle while the work of shipping remains disrupted.

512 will attempt to point his rifle at the Edgerunners when they enter the HQ office, but Depuy will wave him off with a sigh and the shake of a head. *"They've gotten this far,"* he tells his colleague, *"let's just talk first."*

If John Doe is with the team, 512 will lower his rifle to a low ready position and tip him a brief, if mocking salute, and Doe will return the gesture with a blown kiss. Seems like there's history between the two. If John Doe is absent, then he will just lower his rifle to low ready and watch the Crew from behind his mirrorshades, alert but not alarmed.

There are several chairs by the desk ConEx is sitting at. They are insufficient to hold the entire Crew, but there are also nearby crates and desks on which they can perch. Depuy offers them cups of Koff Pop as they parley, but will not be offended if they refuse.

*"I assume you're Fixie's troubleshooters, then,"* Depuy continues after everyone is settled to their satisfaction. *"What's she offering you to kick us out? I could offer*

*better, but I'd have to know the terms first,"* he says, waving a well-manicured hand in what is supposed to be a casual manner.

As the Crew probably remembers, Fixie offered them nothing but advice—but they do have the box of suits to get back for Shears, and there's the folks at the RC Night Market who are begging them to get business back to normal. Still, they can most definitely bluff, if they're willing to bargain. Depuy is willing to pay each of the Edgerunners up to 100eb to leave him alone, since they've gone through enough of his mooks that he won't have to pay as many of them for security come the end of the week. He'll even let them leave with the suits.

This, however, means that the services of Fixie's couriers will be denied to most of Night City's street merchants until Depuy and his crew get things realigned to their liking. And that would also make the Chicken Lady sad.

You wouldn't make her sad, would you?

Of course, if they really wanted to be the kind of folks who are known as A-holes, then they can even deal with Depuy, give John Doe his suit, and then sell the others on the black market. That would make them a pretty eddy... but also piss off Shears, whose clients include people such as John Doe.

If the Crew wavers in their discussion, remind them of the nice, home-made sack lunches Shears packed for them, just to rub it in a little. But it's a hard life out there, choomba, and certainly enterprising Edgerunners can't be faulted for trying to make a quick buck.

If the Crew decides to dislodge Depuy, they have two options: combat, and negotiation. Edgerunners can make a DV 15 Business or Streetwise Check to realize that while Depuy is sitting in a very defensible location, he's only remained unmolested by angry couriers because they want the stuff being shipped to remain intact. Perishables in the warehouse will continue to perish as he sits around trying to figure out the scheme Fixie used to mark addresses and drop points... and eventually his advantage will dwindle to nothing.

He is in, as some would say, a fairly untenable situation. Any Edgerunners taking pity on him might be able to work out a deal with Fixie herself. She could be persuaded to let him leave without a beating if they

# HAVEN'T GOT A STITCH TO WEAR

deliver photographic proof via Agent that the warehouse and goods are unharmed. They are, of course, going to have to persuade him that it's a good idea to cut his losses before he winds up with a bad case of lead poisoning.

A useful bluff would be to imply that all of Night City is up in arms about this disruption in commerce (which is not entirely untrue), and that several teams are getting ready to come down here to set things right. The Crew is just the first to arrive. Deal with them now and things can go easy; Depuy can walk away relatively clean. The next team might not be prepared to negotiate. And Depuy knows he only has so many boostergangers.

There is also the option of a good old-fashioned firefight, which is the harder option, since the Crew is surrounded by Lightning Logistics.

If there are fewer Crew than adversaries in the office, then have Sugarplum the Netrunner make a break for it, because it's not worth her neck to take over this "stinking rusty ship," as she would say. She will not fight back if left to flee, and will not bring reinforcements. Depuy himself may decide discretion is the better part of valor with a professional like John Doe backing the Crew up—at which point, 512 will stay and fight because it's what he does, and he's a professional too.

For fun and color, the GM is encouraged to have Edgerunners take cover behind fragile packages that break entertainingly when shot through. People will ship *anything* via Fixie's couriers, as it turns out. Socks. Underwear. Live crickets in 1m/yd by 1m/yd by 1m/yd cardboard boxes. Highly volatile chemicals. The sky's the limit.

Once the Crew has dealt with Lightning Logistics via negotiation, combat, or another method, **GO TO RESOLUTION (THE DENOUEMENT).**

## RESOLUTION (THE DENOUEMENT)

Assuming the Crew did the "right" thing by evicting Depuy and his crew from the *Rambling Rose*, the mooks will beat a retreat because it's not really worth getting shot at for no pay. This will allow Fixie to return to the *Rambling Rose* with her other couriers in tow, and the Edgerunners are feted for having returned street life there back to normal.

Depending on how trigger-and-explosion-happy the Crew may have been, Fixie may return to a complete shambles of an HQ. In that case, she will be grateful nevertheless, but her gratitude may not be as emphatic. She will retrieve the box of suits they are looking for and hand it over.

Assuming they worked together, this is where John Doe will part ways with the Crew—once he has reclaimed his favorite suit. "You're not a bad crew to work with," he says, with his usual dissonant calm, before he hands one of them a calling card with his number on it. The number, if called, leads to a burner voicemail box that he checks occasionally. Leave a means of contacting you in your message, and he'll get back to you. Any Edgerunners who play Elflines Online might encounter a team of synchronized elves in the future, who may help them out of a tight spot or defend them against hostile PKers, and then run off into the simulated wilderness. Checking in with John Doe after the coming weekend might result in him asking an Edgerunner he particularly clicked with to dinner. He will be wearing another very nice suit.

Shears will be extremely relieved to get the suits back. They will pay the Crew the agreed-on fee, and add one of them to the customer files at Torrell and Chiang. That means a free, full set of personally tailored Businessware for that Edgerunner (**SEE CP:R PAGE 356**).

The merchants at the RC Night Market are equally effusive and grateful. If the Crew allowed Fixie to reclaim her HQ, they will reward the Edgerunners as promised, and continue to be useful contacts in the future.

If the Crew alienated John Doe, then they now they have a professional black-bagger upset with them, which might be a bigger problem.

If the Crew decided to be enterprising A-holes, they lose the rewards from Shears and the RC Night Market vendors, but are able to flog the remaining suits in the package for about 1,000eb per Edgerunner. Don't let John Doe know what they did, he'll be a bit put off by their disrespect for the bond between a suit and their owner.

Both the above options will cost them any chance at a bespoke suit from Torrell and Chiang, naturally. You don't bite the hand that's fitting you for a garment unless you want the rise of the trouser to be way too short, forcing a perma-wedgie.

# HAVEN'T GOT A STITCH TO WEAR

## NET ARCHITECTURES

### ▶ RAMBLING ROSE

Currently controlled by Sugarplum via a Virus. She stays jacked into the system unless fleeing.

**Demons Installed:** None

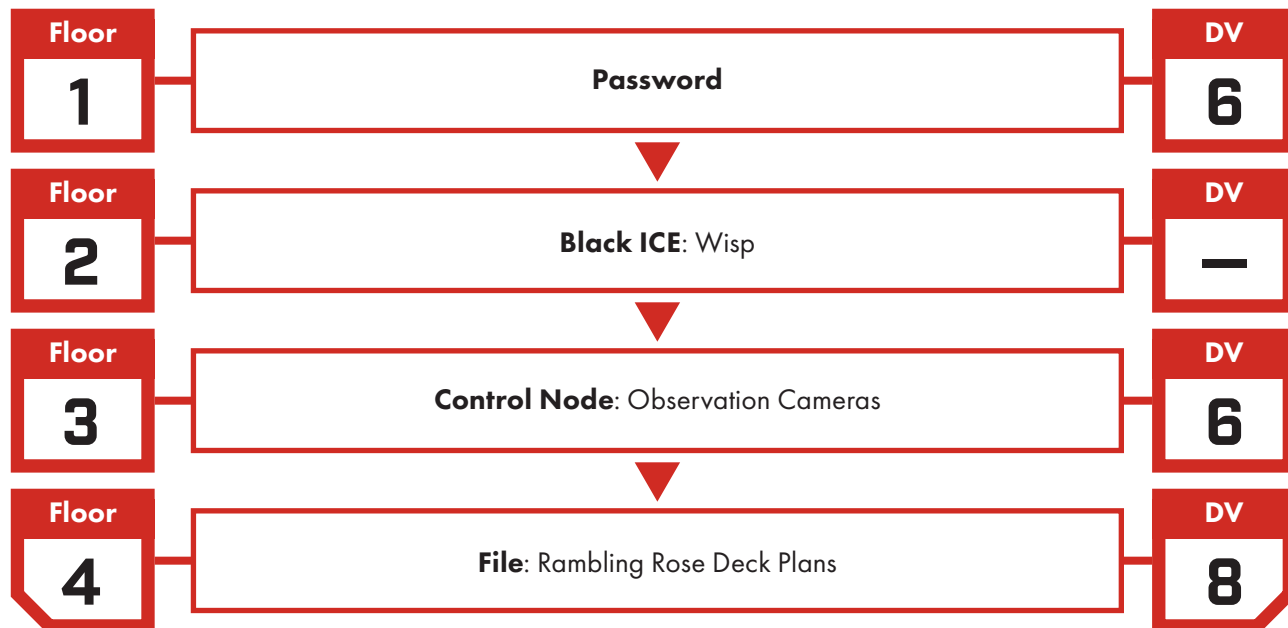

## NPC STAT BLOCKS

For more information on important NPCs **SEE APPENDIX B: BIOGRAPHIES.**

<b>NAME</b> <b>CONEX (REP 2)</b>	<b>SERIOUSLY WOUNDED</b> <b>20</b>	<b>HP</b> <b>40</b>
<b>ROLE</b> <b>EXEC: TEAMWORK 3 (COMPANY DRIVER - WHEELS)</b>	<b>DEATH SAVE</b> <b>5</b>	

### STATS

**INT** 5 **REF** 7 **DEX** 7 **TECH** 3 **COOL** 6 **WILL** 7 **MOVE** 5 **BODY** 5 **EMP** 5

### WEAPONS

<b>HEAVY PISTOL</b>	<b>ROF2</b>	<b>3d6</b>	<b>KEVLAR® (HEAD)</b>	<b>SP 7</b>
<b>NONE</b>	<b>—</b>	<b>—</b>	<b>KEVLAR® (BODY)</b>	<b>SP 7</b>

### ARMOR

### SKILL BASES

Accounting 11 • Athletics 9 • Brawling 9 • Bureaucracy 11 • Business 11 • Concentration 9 • Conversation 11 • Deduction 11 • Education 11 • Evasion 13 • First Aid 5 • Handgun 13 • Human Perception 11 • Language (English) 9 • Language (Streetslang) 7 • Lip Reading 11 • Local Expert (Heywood Industrial Zone) 7 • Perception 9 • Personal Grooming 10 • Persuasion 12 • Stealth 9

### GEAR

Heavy Pistol Ammo x16 • Agent • Computer • Vial of Synthcoke

### CYBERWARE

Biomonitor

SEE PAGE 183 FOR BIOGRAPHY

# HAVEN'T GOT A STITCH TO WEAR

SEE PAGE 192 FOR BIOGRAPHY

NAME	512 (REP 2)	SERIOUSLY WOUNDED	23	HP	45												
ROLE	SOLO: COMBAT AWARENESS 4	DEATH SAVE	7														
<b>STATS</b>																	
INT	7	REF	7	DEX	6	TECH	5	COOL	7	WILL	6	MOVE	7	BODY	7	EMP	2
<b>WEAPONS</b>						<b>ARMOR</b>											
ASSAULT RIFLE w/ SMARTGUN LINK						ROF1		5d6		L ARMORJACK (HEAD)		SP 11					
HEAVY MELEE WEAPON						ROF2		3d6		L ARMORJACK (BODY)		SP 11					
<b>SKILL BASES</b>																	
Athletics 8 • Autofire 13 • Brawling 8 • Concentration 8 • Conversation 5 • Education 9 • Evasion 12 • First Aid 11 Handgun 13 • Human Perception 5 • Interrogation 13 • Language (German) 11 • Language (Streetslang) 9 Local Expert (Heywood Industrial Zone) 9 • Melee Weapon 12 Perception 13 • Persuasion 9 • Resist Torture/Drugs 12 Shoulder Arms 13 • Stealth 8 • Tactics 13																	
<b>GEAR</b>																	
Rifle Ammo x50 • Agent																	
<b>CYBERWARE</b>																	
Neural Link w/ Interface Plugs																	

NAME	SUGARPLUM (REP 1)	SERIOUSLY WOUNDED	18	HP	35												
ROLE	NETRUNNER: INTERFACE 3	DEATH SAVE	6														
<b>STATS</b>																	
INT	6	REF	6	DEX	6	TECH	7	COOL	8	WILL	4	MOVE	7	BODY	6	EMP	4
<b>WEAPONS</b>						<b>ARMOR</b>											
VERY HEAVY PISTOL						ROF1		4d6		BODYWEIGHT SUIT (HEAD)		SP 11					
NONE						-		-		BODYWEIGHT SUIT (BODY)		SP 11					
<b>SKILL BASES</b>																	
Athletics 8 • Basic Tech 10 • Brawling 8 • Concentration 6 • Conversation 6 • Education 12 • Electronics/Security Tech 12 Evasion 12 • First Aid 9 • Handgun 12 • Human Perception 6 • Language (Spanish) 10 • Language (Streetslang) 8 • Library Search 12 • Local Expert (Heywood Industrial Zone) 8 • Perception 8 • Persuasion 10 • Stealth 12 • Wardrobe and Style 10																	
<b>GEAR</b>																	
Very Heavy Pistol Ammo x8 • Agent • <b>Cyberdeck Hardware:</b> Insulated Wiring (in Bodyweight Suit) • <b>Cyberdeck Programs:</b> Armor x2 • Poison Flatline • See Ya • Sword • Vrizzbolt • Worm																	
<b>CYBERWARE</b>																	
Cyberarm w/ Cyberdeck • Neural Link w/ Interface Plugs																	

SEE PAGE 192 FOR BIOGRAPHY

# HAVEN'T GOT A STITCH TO WEAR

SEE PAGE 183 FOR BIOGRAPHY

<b>NAME</b>	<b>BOOM-BOOM</b> (REP 1)			<b>SERIOUSLY WOUNDED</b>	<b>18</b>	<b>HP</b>	<b>35</b>
<b>ROLE</b>	<b>TECH: MAKER 2</b> (FIELD EXPERTISE 2, FABRICATION EXPERTISE 2)			<b>DEATH SAVE</b>	<b>6</b>		
<b>STATS</b>							
<b>INT</b>	<b>7</b>	<b>REF</b>	<b>7</b>	<b>DEX</b>	<b>7</b>	<b>TECH</b>	<b>6</b>
				<b>COOL</b>	<b>3</b>	<b>WILL</b>	<b>3</b>
						<b>MOVE</b>	<b>6</b>
						<b>BODY</b>	<b>6</b>
						<b>EMP</b>	<b>5</b>
<b>WEAPONS</b>				<b>ARMOR</b>			
VERY HEAVY PISTOL				ROF1	4d6	L ARMORJACK (HEAD) SP 11	
HEAVY MELEE WEAPON				ROF2	3d6	L ARMORJACK (BODY) SP 11	
<b>SKILL BASES</b>							
Athletics 11 • Basic Tech 11 • Brawling 9 • Concentration 5 • Conversation 7 • Cybertech 11 • Demolitions 12 • Education 10 Electronics/Security Tech 11 • Evasion 11 • First Aid 10 • Handgun 12 • Human Perception 7 • Language (English) 11 Language (Streetslang) 9 • Local Expert (Heywood Industrial Zone) 9 • Perception 9 • Persuasion 5 • Stealth 7 • Weaponstech 12							
<b>GEAR</b>							
Very Heavy Pistol Ammo x16 • Armor Piercing Grenade x2 • Incendiary Grenade x2							
<b>CYBERWARE</b>							
Cyberarm w/ Tool Hand							

SEE PAGE 186 FOR BIOGRAPHY

<b>NAME</b>	<b>JOHN DOE</b> (REP 3)			<b>SERIOUSLY WOUNDED</b>	<b>20</b>	<b>HP</b>	<b>40</b>
<b>ROLE</b>	<b>TECH: MAKER 4</b> (FIELD EXPERTISE 4, FABRICATION EXPERTISE 4, UPGRADE EXPERTISE 2) <b>SOLO: COMBAT AWARENESS 2</b>			<b>DEATH SAVE</b>	<b>7</b>		
<b>STATS</b>							
<b>INT</b>	<b>8</b>	<b>REF</b>	<b>6</b>	<b>DEX</b>	<b>7</b>	<b>TECH</b>	<b>8</b>
				<b>COOL</b>	<b>4</b>	<b>WILL</b>	<b>4</b>
						<b>MOVE</b>	<b>6</b>
						<b>BODY</b>	<b>7</b>
						<b>EMP</b>	<b>5</b>
<b>WEAPONS</b>				<b>ARMOR</b>			
ASSAULT RIFLE				ROF1	5d6	L ARMORJACK (BODY) SP 11	
HEAVY PISTOL				ROF2	3d6	NONE —	
<b>SKILL BASES</b>							
Athletics 12 • Autofire 12 • Basic Tech 14 • Brawling 12 • Concentration 12 • Conversation 9 • Cybertech 12 • Education 12 Electronics/Security Tech 14 • Evasion 12 • First Aid 12 • Handgun 12 • Language (English) 12 • Language (Streetslang) 10 Local Expert (The Glen) 12 • Perception 12 • Personal Grooming 8 • Persuasion 8 • Pick Lock 12 • Resist Torture/Drugs 10 Shoulder Arms 12 • Stealth 14 • Tactics 14 • Wardrobe and Style 8 • Weaponstech 12							
<b>GEAR</b>							
Rifle Ammo x50 • Heavy Pistol Ammo x8 • Agent • Duct Tape • Smart Glasses w/ Low-Light/Infrared/UV Tech Bag • Techtol							
<b>CYBERWARE</b>							
Contraceptive Implant. Neural Link w/ Sandevistan							



# REAPING THE REAPER

## A PREVIOUS RELATIONSHIP

If the Crew has played through the **Digital Divas Burn it Down** or **Don't Fear the Reaper** Missions from **Cyberpunk RED Data Pack**, they'll know Major Stiles and know how her daughter, Jezz, stepped in front of a truck during a concert thanks to the machinations of an AI known as The Reaper. Don't Fear the Reaper ended with the destruction of a laptop containing The Reaper but it appears Major Stiles believes at least one other copy of the AI lurks out there in Night City.

## BACKGROUND (READ ALOUD)

*The Forlorn Hope, a place where Edgerunners go to drown their sorrows and swap war stories. Occasionally, gangers decide to storm the bar and discover, to their regret, that it is well defended. Today, damage from a recent battle can still be seen in the form of bullet marks on the outer walls and faint bloodstains not yet scrubbed from the sidewalk. To most this just adds personality to the place.*

*You've come to the Forlorn Hope with a purpose: to meet a client and get work. At this time of day, most of the tables are empty. In the corner, a bald man wearing a worn old Trauma Team t-shirt impassively repairs an Edgerunner's broken cyberarm. Behind the bar, a pink-haired bartender sorts through inventory while chatting with a lanky, well-muscled woman who tunes her chromed-out guitar.*

## THE REST OF THE STORY

Months ago, an unknown Netrunner found an access point to the Old NET and managed to download an AI called the Reaper. Insidious, charming, and cruel, the Reaper whispered poison in the Netrunner's ear, driving them to suicide. A fellow Netrunner stole the dead one's gear and the process began all over again. And so it went, as the Reaper passed through a chain of Netrunners until it ended up in the hands of the DJ of MindNutz Lovers, a new braindance club. With each Netrunner, the Reaper learned something new: how to make copies of itself, for example, or how to influence human minds. And with the DJ, the Reaper learned the greatest trick of all: how to exploit a security flaw in a specific brand of Internal Agent to burrow into a person's brain and turn them into a living Biodrone. Almost immediately, the Reaper got sick of recruiting a single Biodrone at a time and sought a solution. The answer

came in the form of an old radio tower — by taking it over, the Reaper could take control of anyone with the right Internal Agent in range of the tower's broadcast signal. With each Biodrone recruited, the Reaper comes one step closer to its ultimate goal: chaos and destruction.

The Reaper's last victim, before the DJ, was Jezz Stiles. Her mother, Major Veronica Stiles, has worked tirelessly since Jezz's death, seeking answers. Over time, she's learned about the Reaper's existence. She's studied it. Learned about it. And now she believes she has the resources to find the Reaper and finally get vengeance for her daughter's death.

## THE SETTING

The mission begins at the Forlorn Hope, one of Night City's most storied Edgerunner bars. From there, the Crew will visit the docks in the Upper Marina, where they'll fight a squadron of drones before moving onto Guǎngbō Tower in Little China. At the top of the Tower, in a virtuality arcade, they'll discover a horrible truth: the Reaper isn't just controlling mechanical drones but biological ones as well.

After some rest, the Crew will be back on the job, picking up a package in Pacifica Playground. After a brief skirmish with Biodrones, and some lunch, they'll take a trip to the Hot Zone to activate an old radio receiver and find the location of their final battle against the Reaper: a braindance club in South Night City known as MindNutz Lover.

## THE OPPOSITION

- **The Reaper** lives in NET Architectures and comes in three forms: two lesser and obedient copies, known as **ReaperA** and **ReaperB**, and the original AI itself, **Reaper Prime**.

- Initially, the Reaper sends **mechanical drones** after the Crew in the form of two Air Swarm Drones and a Large Air Drone armed with a Very Heavy Pistol (fully loaded with Armor Piercing Ammunition).
- As the story progresses, the Crew encounters the **Biodrones**: people whose brains have been hollowed out by the Reaper and transformed into nothing more than meat puppets. **Melee and Ranged Biodrones** form the bulk of the Reaper's army but some upgraded **Biodrones+** make for tougher opponents.
- Reaper Prime's NET Architecture is carried by the **Biodrone DJ**, a formidable combatant with some combat upgrades.

SEE PAGE 108 FOR STAT BLOCKS

## THE HOOK

As the Edgerunners come closer, they overhear the discussion between the bartender, Marianne Freeman, and the Rockerboy, Grace Steel.

"... just saying, you could have taken it easy, Grace. You didn't need to bust their arm." Marianne notes.

"They'll think twice 'fore challengin' people to arm wrestlin' now, won't they?" Grace replies, "'sides, Doc Stoic'll fix it up. Ways I see it, I did 'em a favor. Now they know the cyberarm they got last week's crap. Better they find out now and not in the middle of a real fight."

When the Crew's close enough, Marianne acknowledges them.

"You must be Vicky's nooner," the bartender says with a sly smile, "Go on back. Look for some silver on the hill. Can't miss it."

Following the bartender's directions, the Crew will find Lieutenant Tanzia, a woman with short auburn hair, guarding a door. She motions them into the room without a word. Inside the office are two chairs sitting in front of a metal desk. Behind the desk is a woman wearing a trenchcoat and mirrorshades. She motions for the characters to sit (two can sit, the rest will be stuck standing). The office door shuts once everyone is inside.

This is Major Veronica Stiles, a Militech Exec.



BY STORN A. COOK

Marianne Freeman

If the Crew has done work for Major Stiles in the past, she exchanges brief pleasantries. Otherwise, she introduces herself and then gets to the point.

"I require your services to retrieve a device on order from Faisal's Customs and deliver it to my operative, Lieutenant Tanzia, at a specific location. You will then act as logistical support for the Lieutenant until the job is complete. I need to stress that, although I work for Militech, this is a personal operation. You'll be helping to hunt down the rogue AI responsible for my daughter's death. Once the job is finished you'll get paid 1,000eb each."

With an appropriate Skill Check (Deduction, Education, Library Search, and Local Expert are great Skills to use here) against a DV 13 Edgerunners who don't already know can realize Major Stiles lost her daughter, Jezz, several weeks ago. Jezz ran into oncoming traffic during a Digital Divas concert.

Rumors link Jezz's death to The Reaper, an AI of urban legend who reportedly jumps from Netrunner to Netrunner, driving each to suicide.

Once they accept the mission, Major Stiles gives the

# REAPING THE REAPER

Crew an address: a location in the Upper Marina and instructs them to head out as soon as possible.

## GO TO DEV (THE PICKUP)

### DEV (THE PICKUP)

The address the soldier gave the characters is located right on the docks. The area is packed with cargo containers and two large cargo ships, one with a gaping hole in the side, rest against massive concrete piers. Dockworkers move crates and equipment around. Drones buzz overhead, directing supply traffic. One of the workers will approach the Crew.

*"Hey, do you guys have business here or are you sightseeing? Because we don't got no time for sightseers."*

A drone will swoop down and project a red arrow

on the ground in front of the Edgerunners. An electronic voice instructs them to follow the arrow. The worker shakes his head and walks away, going back to work.

The drone leads the characters through a valley of old yellow cargo containers until they reach a red one. When the characters get to within ten feet of the container the red arrow vanishes. The drone hovers nearby and issues a prompt.

*"Client name, please."*

The second someone says the Major's name the drone thanks them and flies off. Moments later the red cargo container opens. The container is empty except for a single open crate at the far end and a treaded drone with arms and a monitor attached to the chest area. It will roll forward and the image of Faisal, the owner of Faisal's Customs, appears on the screen.

*"Welcome clients! I think you'll find this tool handy in tracking down your problem. I custom-designed it to the exact specifications given to me. Thank you for your business and come again!"*

The screen goes blank and the drone holds out what appears to be a heavily modified Techscanner before rolling back into the empty crate. As the Crew exits the container, they hear a buzzing sound. In the sky, a green cloud approaches.

## GO TO CLIFF (DRONE FIGHT)

### CLIFF (DRONE FIGHT)

Approaching the Crew are two Air Swarm Drone Clouds (SEE PAGE 174). Trailing behind the Air Swarms is a Large Air Drone (SEE PAGE 174) armed with a Very Heavy Pistol (fully loaded with Armor Piercing Ammunition). The NET Architecture (SEE PAGE 107) responsible for controlling all three drones is built into the Large Air Drone's chassis and contains a lesser variant of the Reaper known as ReaperB (SEE PAGE 107).

As the Swarms approach the Crew, they assume the shape of a large human skull that laughs and babbles in a strange, mechanical binary language. One Swarm targets whichever Edgerunner carries the scanning device made by Faisal while the other attacks the most obvious threat on the field. The Large Air Drone stays at a distance, out of the virtual reach of any Netrunners until one of the Swarms is destroyed. At which the Large



BY NEL BRANQUINHO

# REAPING THE REAPER

Air Drone closes in, entering combat. At that point, if the Crew has a Netrunner, they can attempt to connect with the NET Architecture. In NET Combat, ReaperB will always use two NET Actions to direct the drones before engaging a Netrunner.

If the two Swarms are defeated, they'll rain to the ground and be Destroyed Beyond Repair. The Large Air Drone can be salvaged but the NET Architecture will melt into slag once the Drone or The ReaperB inside are defeated. In other words, the NET Architecture is Destroyed Beyond Repair as well.

With the battle over, and the device acquired, the Crew should move on to meet Lieutenant Tanzia.

## GO TO DEV (A HUNTING PARTY)

### DEV (A HUNTING PARTY)

The drop-off point is on the border of the Upper Marina and Little China. There is an unmarked black truck parked by a sign that reads "One Hour Parking" with another message spray-painted in red hanzi under it (it translates to "at your own risk"). Across the street, a group of kids runs around a burnt-out NCPD cruiser playing cops and gangers. Standing in front of the black truck is the woman with auburn hair who was standing guard for Major Stiles at The Forlorn Hope.

As the Crew approaches, the woman steps forward.

*"I am Lieutenant Tanzia. I'll be taking custody of the item you retrieved and leading the next stage of this operation."*

After being handed the device, the Lieutenant bangs on the truck door, twice. The door opens and a skinny little pixie emerges, their purple hair spiked out to look as if their head exploded. From the scowl on the Lieutenant's face, there's a good chance she wishes that was the case. The Lieutenant speaks again.

*"This is Sall3 Smite. They'll be providing tech support for this operation. Sall3, is the scanner operational?"*

Sall3 (SEE PAGE 108) takes the device and starts inputting numbers, seemingly at random. Soon it begins beeping.

*"Sweet beans! This'll let me cover a few blocks at a time! And look! We got a hit right off the bat. That way, El Tee!"*

Lieutenant Tanzia (SEE PAGE 108) peers in the direction indicated by Sall3 and mutters to herself, *"Inside the Little China Combat Zone. Great. Time to earn your pay, people. Let's rock and roll."*

The scanner leads the Crew four blocks into Little China. Despite being a Combat Zone, this part of Little China shows signs of life and development, with construction started on several buildings.

The average citizens of Little China run very hot and cold when it comes to outsiders. They'd stop to socialize, but half the time they're sizing up strangers to see if they may be a threat or not. If not, there is no point chit-chatting considering the next threat could be around the corner.

That's not to say that the people here are anti-social, they can be seen in the streets chatting with one another. The atmosphere is almost normal.



BY DIEGO MARTINEZ

Lieutenant Tanzia

## SPICING UP THE TRIP

The trip through Little China leads straight ahead without much conflict. GMs who want to spice things up can make use of the Encounters in the RED section of the core rulebook (SEE CP:R PAGE 417) to throw a few obstacles or interesting events in the Crew's way. If combat breaks out, Lieutenant Tanzia's priority is to protect Sall3 and she'll rely on the Crew to chase off or end the threat.

## THE LCRA

With an appropriate Skill Check, an Edgerunner can know more about the Little China Redevelopment Association. On the surface, it is a conglomerate formed by wealthy members of Night City's Chinese community for the express purpose of revitalizing Little China. Thus far, the LCRA has only managed to secure and begin rebuilding a few blocks. The involvement of David Ling Po, rumored to be head of the Weng Fang Tong, indicates the LCRA might have a dark side as well.

This part of Little China is controlled by the Little China Redevelopment Association (LCRA). To keep the area relatively safe, the LCRA backs a local boostergang, the Gold Dragons, who are happy to provide security in exchange for money.

During the trip, Tanzia remains quiet and on alert. She's not interested in chitchat. Sall3, on the other hand, is quite keen to chatter about her past, technology, and The Reaper. They figure the AI is a R.A.B.I.D. and wants to do to people's brains what the DataKrash did to the old NET.

The block where the tracker directs the Crew is busy. Street vendors and pedestrians are moving about. People seem less concerned about sudden attacks and less beaten down by life. This is clearly the center of the Little China Redevelopment Association's efforts.

Sall3 cheerfully and dramatically motions to an ancient, thirty-story building.

"Looks like we're hunting wascally wabbits up at the top, El Tee!"

A burnt-out neon sign indicates the building was once home to KLIA 99.2, a radio station. Scaffolding along the sides indicates an ongoing effort to rehabilitate the structure.

Most of the building lies derelict but a few different tenants have already moved in, including a medical clinic, the Ling Po Public Library, and a variety of small businesses. A sign on the sidewalk indicates the top floor is home to Virtex's Virtuality Venue, an arcade, but a label has been slapped on to indicate Virtex's is closed for renovations.

Just through the building's main doors is a large lobby. There are holo-scenes on the walls of ancient Chinese landscapes and inoffensive, older Cantopop plays on the speakers. Two Gold Dragons (use **Boosterganger**, PAGE 172) lounge about to provide security but won't interfere

with the Crew unless they start trouble. At the front desk is a receptionist dressed in smart Businesswear, who greets them immediately.

"Welcome to Guǎngbō Tower. How may I direct your visit?"

The receptionist will answer basic questions about the building and direct the Crew to either the stairs or the elevators.

Among the questions the receptionist will answer:

### ▶ WHAT IS THIS PLACE?

"Before the 4th Corporate War, Guǎngbō Tower was once home to KLIA 99.2, a radio station specializing in news and radio dramas. Last year, the Little China Redevelopment Association purchased the building and began renovating it. It is already home to over twenty new tenants!"

### ▶ HOW TALL IS THE BUILDING?

"The building is thirty stories tall. Thirteen of the stories are currently occupied by tenants. The rest are under construction and the elevator will not stop there."

### ▶ WHAT IS THE LING PO PUBLIC LIBRARY?

"The Ling Po Public Library was financed and named for Mister David Ling Po and represents his investment in the future of this area. It offers many services to the community but can only be accessed by residents of Little China. It is located on the tenth floor."

### ▶ WHAT IS VIRTEX'S VIRTUALITY VENUE?

Virtex's Virtuality Venue is located on the top floor of the building and is one of the most popular attractions in Little China and boasts the hottest and most advanced games! Unfortunately, Virtex's is closed for renovations as of this morning.

## ▶ WHAT ELSE IS IN THE TOWER?

The tower is home to a variety of small businesses as well as a medical clinic. The medical clinic occupies the third floor. Various small businesses can be found in offices located on the second, ninth, fifteenth, and twenty-third floors.

Trying to get more information about Virtex's Virtuality Venue out of the receptionist will require a successful Persuasion or Conversation Skill Check against DV 13. If the Check succeeds, the receptionist will admit they don't know exactly how Virtex's is being renovated but she has seen various people entering the elevator carrying technical equipment and traveling to the top floor so there's no reason to doubt it. Also, since Virtex's is closed, the elevator won't stop on the top floor without an appropriate keycard. If they succeed against a DV 15, the receptionist adds more information, noting earlier in the day several people mentioned the elevator control panel glitching briefly. She's already informed the building super.

Eventually, Lieutenant Tanzia will push the Crew forward, making it clear she wants to reach the top floor.

If the Crew takes the elevator up, **GO TO CLIFF (FREEFALL)**.

If the Crew takes the stairs up, **GO TO CLIFF (THE LONG CLIMB)**.

## CLIFF (FREEFALL)

Inside the elevator, the touchscreen control panel only allows access to open floors. Accessing the thirtieth floor and Virtex's Virtuality Venue requires either a keycard or a DV 15 Electronics/Security Check. The keycard can be acquired from the receptionist via a DV 13 Persuasion, Pick Pocket or Bribery Skill Check. If no one can perform the Electronics/Security Check, Sall3 will step in and do it.

On the way to the thirtieth floor, the elevator's control panel begins glitching. Edgerunners who succeed at a DV 13 Perception Check will notice that each time the panel glitches a green skull appears on the display in place of a floor number. At the 23rd floor, the lights on the elevator begin to flicker on and off. Each time the elevator goes dark the skull becomes more and more visible. Finally the elevator slams to a stop. Each Character, including Lieutenant Tanzia and Sall3, will need to make a DV 13 Athletics Check or be slammed to the ground, taking 1d6 damage. The lights go out and a familiar electronic binary laugh plays through the speakers. A green glow illuminates the inside of the elevator as the green skull dances across the control panel's display. Any attempt to stop the elevator or access the controls before the sudden stop will trigger it.

"L-l-l-ast s-s-s-stop-p-p-p."

"Oh, shit! It's the wabbit!" Sall3 shouts.

The elevator starts to drop. Fast. In fact, it is falling faster than gravity would allow, meaning everyone inside is thrown up against the ceiling. Each Character, including Lieutenant Tanzia and Sall3, must make a successful DV 13 Endurance Check or take 1d6 damage.

The Crew has 5 Rounds before the elevator crashes at the bottom of the shaft.

To activate the elevator's emergency brakes, someone will need to reach the control panel and rewire it with a DV 15 Electronics/Security Tech Check. Reaching the control panel will require a DV 15 Athletics Check. If no one in the Crew is capable of rewiring the elevator, Sall3 will automatically succeed at the Check but will require help getting to the control panel. Pushing Sall3 to the panel requires a DV 15 Athletics Check.

Each of the above Checks takes one Action to perform.

## WHAT ELSE IS HERE?

We've left most of the tenants of Guāngbō Tower unnamed for a reason. This is a great chance for the GM to include a few small businesses as plot hooks, future mission fodder, or to work into the Crew's Lifepath.

# REAPING THE REAPER

If the Crew succeeds in rewiring the control panel, they can bring the elevator to a gentle stop so as not to slam anyone down to the floor again. They now have full manual control and can force the elevator to the top floor without interruption. **GO TO DEV (VIRTEX'S VIRTUALITY VENUE).**

If the Crew fails to take control of the elevator, all present Characters hit the bottom hard, taking 6d6 damage and, unless they succeed at a DV 15 Athletics Check, suffer the Broken Leg Critical Injury. Cyberlegs do not help with this fall.

Moments after the elevator crashes, they're pulled out of the wreckage by the Gold Dragons in the lobby. The receptionist, horrified by the incident, offers a profuse apology and immediately summons Medtechs from the building's clinic. At the receptionist's instructions, the Medtechs administer a dose of Speedheal (**SEE CP:R PAGE 150**) to each injured person and Quick Fix any Broken Leg Critical Injuries. This includes Lieutenant Tanzia and Sall3. The Medtechs automatically succeed at the Paramedic Check required for the Quick Fix. The cost of the treatment will be covered by the LCRA.

Unless she is dead, Lieutenant Tanzia insists they carry out the mission. If Sall3 is dead, the Lieutenant says the Tech understood the risks and promises mourning will come later. She instructs the Medtechs present to preserve the body.

The Crew now has a choice: they can climb the stairs to the 30th floor or press their luck on one of the other elevators. If they climb, **GO TO CLIFF (THE LONG CLIMB)**. If they take the elevator, this time they have no trouble reaching the top floor.

## GO TO DEV (VIRTEX'S VIRTUALITY VENUE)

### CLIFF (THE LONG CLIMB)

If the Crew takes the stairs they are in for a long haul. The air in the stairwell is stale and by the time the characters hit the fourth floor, they will realize that the ventilation system isn't functioning properly, making an already tough climb even more difficult.

A door leads from the stairs into the building on each floor but all are locked and will only open with the right keycard or a DV 13 Electronics/Security Tech or Pick

Lock Check. Most doors open onto empty floors, still under construction. Others open into the medical clinic, the public library, or corridors with doors leading to various small businesses. If, at any point, the Crew steps off the stairway and steps into an elevator (and hasn't used the elevator before), **GO TO CLIFF (FREEFALL).**

If the Crew makes it to the twenty-ninth floor, they should make a Perception Check (DV 13). If they succeed, they'll hear a door opening on the 30th floor up above and then the thump-thump-thump of an Armor Piercing Grenade (**SEE CP:R PAGE 345**) rolling down the stairs to their present position. Everyone present can make a DV 13 Evasion Check to dodge the blast, even if they normally aren't able to dodge ranged attacks. The enemy will only drop one grenade before ducking back inside the thirtieth floor and locking the door again.

As they reach the thirtieth floor, the Crew should make a DV 13 Endurance or Resist Torture/Drugs Check unless they have their own oxygen supply. If they fail, they're winded and take a -1 penalty to all Checks involving physical activity until they can rest for an hour.

## GO TO DEV (VIRTEX'S VIRTUALITY VENUE)

### DEV (VIRTEX'S VIRTUALITY VENUE)

As the door opens a gust of putrid air pours out. It smells like death. A quick spot check reveals that the lights are off. The only illumination comes from the emergency lighting system, bathing the area in a sickly red glow. A handful of bodies lie here, broken and mangled. One victim has a fire ax wedged in their skull. In her head, a cybereye and random protruding wires spark. Other bodies look as if they have been chopped up. Shell casings litter the floor. Up ahead, the entrance to Vortex's Virtuality Venue, decorated with cheerful and colorful characters, beckons.

Sall3 turns away and retches, her hands on her knees.

Searching the bodies reveals nothing salvageable other than two Heavy Pistols and a Heavy SMG. Each has half a clip. Outside of the sparking sounds, the only other noise appears to be coming from inside the arcade. As the characters approach they'll hear the strange, electronic binary spoken by the green skulls at the docks and in the elevator.

BY NEIL BRANQUINHO



Just past the entrance of the arcade is an atrium, where normally one can purchase admission or wait for the rest of their party. Here lie two more bodies. One wears a t-shirt proclaiming them as staff at Virtex's Virtuality Venue. There's a plastic bag tied around their head. The other is dressed in street clothes. Their body is riddled with bullet holes.

This is a Reaper Biodrone killed during the brief battle for control of the arcade.

## GO TO CLIFF (BIODRONE STRIKE)

### CLIFF (BIODRONE STRIKE)

Just past the atrium lies a recreation area with several braindance stations and other entertainment. There are multiple bodies here; all died in gruesome ways.

As the Crew reaches the center of the room, two of the bodies near the entrance will leap up and attack. These are Reaper Biodrones.

As soon as an Edgerunner gets within total line-of-sight one of the Biodrones (**SEE REAPER BIODRONE (RANGED), PAGE 109**) will raise their weapon and open fire. The other Biodrone (**SEE REAPER BIODRONE (MELEE), PAGE 109**) will rush the Crew.

Detecting the Biodrones before they attack requires a DV 17 Perception Check. Edgerunners with Low Light/Infrared/UV capabilities succeed automatically since the Biodrones can't hide their body heat. If each body is being checked or searched individually, signs of life can be found with a DV 10 First Aid or Paramedic Check.

Examining the area and succeeding at a DV 15 Deduction Check reveals the story: a group of people came into the arcade on a quiet business day and attacked the patrons and staff with firearms and melee weapons. Those patrons who didn't fall in the attack fought back or tried to escape but didn't make it to the elevator or stairs. The position of three of the bodies

# REAPING THE REAPER

in the recreation area suggests they were part of the assaulting force. Given the number of bodies, chances are more assailants than these six (the one in the atrium and the five in the recreation area) were involved in the assault. There's no sign of why they attacked here and this obviously happened within the last twenty-four hours.

When the Crew decides to investigate the back rooms, **GO TO DEV (BIODRONE HUNTING)**.

## DEV (BIODRONE HUNTING)

Just past the recreation area is a shorter hallway. At the end is a room labeled as storage. On the right, is an employee lounge. On the left is an office with the door open.

A placard next to the door once read "Transmitter System" but someone crossed out the words and wrote, in permanent marker, "Virtex's Office". Inside, the only illumination comes from the sickly glow of displays and indicator lights built into the electronic equipment and panels lining the walls. A tall, thin woman, dressed in ragged jeans and a Virtex's Virtuality Venue t-shirt plugs a NET Architecture into one of the panels. A nametag on her shirt proudly proclaims her as 'Virtex'. The woman looks up with cold, dead eyes and shouts out in electric binary. The other doors open and people, chuckling with that cold, electronic laugh, shuffle out, ready to kill.

Virtex's office was once the control center for the radio transmitter on top of the building. The transmitter, and the equipment to control it, are still present and the woman, a Reaper Biodrone+ (SEE PAGE 110) is moments away from completing their task. Any member of the Crew succeeding at a DV 13 Electronics/Security Tech Check can realize connecting the NET Architecture to the transmitter will give whatever's inside the ability to broadcast a signal for miles. If none of Edgerunners realize what's going on, Sall3 does.

*"El Tee! They're trying to broadcast something! We need to cut that connection!"*

### GO TO CLIFF (BIODRONE BLITZ)

## CLIFF (BIODRONE BLITZ)

It will take 5 Rounds for the ReaperA inside the NET Architecture to take control of the transmitter, power it up, and begin broadcasting. To stop it, the Crew must do one of three things:

- Disconnect the NET Architecture server from the transmitter control panel (a DV 15 Electronics/Security Tech Check that requires 3 Rounds to perform). If the Crew tasks Sall3 with the task, she succeeds automatically but still requires the 3 Rounds to complete it. If this occurs, the ReaperA activates a self-destruct protocol, and the NET Architecture fries, becoming Destroyed Beyond Repair.
- Destroy the NET Architecture server. It has 50 HP and will not cease functioning until it reaches 0 HP. If the Crew takes this course of action, Sall3 will warn them of the potential consequences: destroying the NET Architecture while it is plugged into the radio equipment could cause the electrical grid on this floor to overload. When the NET Architecture reaches 0 HP, everyone present takes 6d6 damage as sparks leap from sockets, light fixtures, and other electronic outlets and devices (SEE CP:R PAGE 180 FOR MORE RULES ON ELECTROCUTION). Needless to say, the NET Architecture is Destroyed Beyond Repair.
- Destroy the ReaperA (SEE PAGE 107) inside the NET Architecture (SEE PAGE 107). This has the added advantage of distracting the ReaperA. The ReaperA can't connect to the transmitter during any Round spent engaged in combat with a Netrunner. ReaperA does not need to use NET Actions to command the Biodrones. Once the ReaperA is destroyed, the NET Architecture implodes, becoming Destroyed Beyond Repair.

The Lieutenant will focus on protecting Sall3 and allow the Crew to take the lead during this combat. The opposition is the Reaper Biodrone+ and 1 Reaper Biodrone (a mixture of Melee and Ranged) per Crew member. The Biodrone+ focuses on protecting the NET Architecture, attacking anyone interfering with it. The other Biodrones attack the Crew, fighting to the death.

Once the threat has ended, Lieutenant Tanzania will step off to the side and call Major Stiles before returning.

*"Good work." Tanzania says to the Crew, "Major Stiles thanks you for a job well done. If you return to the Forlorn Hope, you can pick up your payment from Ms. Freeman. We're going to stay behind and analyze the wreckage. I'd like to think we destroyed the Reaper*



# REAPING THE REAPER

*"Yeah, yeah, out back. Down the hallway. First room on the left. Just DON'T touch anything. Go, go."*

The doorway behind Patchz leads to a hallway lined with yet more shelves. The equipment de jure back here seems to be cyberlimbs, but Edgerunners can also see busted-up guns and mono-blades. There is one large duracrete crate containing piles of broken weapons that is almost comparable to a kid's toybox. Overhead UV lights shine, giving everything a purple aura, along with showing all the specks of lint on people's clothes. Just past the crate, there is a doorway on the left. Inside there are three men. Two are rather tall and burly types with slung combat shotguns (use **Bodyguards**, **PAGE 172**, replace Poor Quality Shotgun with Standard Quality Shotgun). Both have black shades and mohawks. The third male is easily recognizable, Faisal. In the center of the room is a workbench, upon which sits a small crate.

*"Good," Faisal says, "You're here. Let me go over what I'm supplying. First, as requested, I've made a wrist-mounted version of the scanner you picked up last time. This one has a shorter range, though, so be aware. I've also processed the data provided*

*and been able to come up with a way to target and scramble the specific frequencies noted. Given the turnaround and the unique challenges of the project, I've only been able to make three of the weapons and had to internalize the power supply. In other words, once you've drained the power, the weapon becomes useless. By the way, we know these things work. They got field-tested."*

Faisal holds up his Agent and projects holographic footage of the docks. One of the bodyguards present approaches a dockworker and shoots the man with a scrambler. The man convulses and drops to the ground, instantly.

*"It turns out one of these whatever-they-are was stationed on the docks. Probably called in when you arrived for the pick-up and that's why the drone fleet came in and attacked. I feel bad about this, so I'm also including a couple of EMP grenades, at no charge. I don't know if they'll do the job in this instance, but it is worth a try."*

Faisal opens the crate to reveal:

- 3 Scramblers (**SEE PAGE 110**)
- 2 EMP Grenades (**SEE CP:R PAGE 345**)
- 1 Wrist-Mounted Reaper Detector

After the characters take custody of the equipment one of the bodyguards ushers the Crew out and back to the front of the shop where Patchz is reattaching the construction worker's arm. He pauses long enough to hit a button and open the front door.

*"Come back if you need any work done or if you come across something I can salvage for you."*

Outside the BnB is a beat-up old groundcar. Standing next to it is a man in a rumpled black outfit.

He'll walk up to the Crew and show them his badge.

*"Renzer. Netwatch. Relax. You're not in trouble. I'd just like to buy you lunch and talk to you. Please."*

**GO TO CLIFF (SUSHI SHOWDOWN)**

## CLIFF (SUSHI SHOWDOWN)

Renzer will walk with the Crew a few blocks over to Mister Rice Guy (**SEE PAGE 154 FOR MORE DETAILS**). He'll pay for any yellow or orange menu



BY CATATAU

item but nothing fancier. Once everyone has their food, he'll rent a private room and start asking questions.

*"I'll get to the point. We're stretched to the breaking point and I'm at the bottom of the ladder when it comes to seniority. Over the past few months, I've spotted a pattern. Seventeen different fatalities. Accidents. Suicides. The kind of stuff Netwatch wouldn't even notice. Except I noticed they were all Netrunners. I dug deeper. Most went right to cremation but five had autopsies that showed unusual burning around their Neural Links. Seven left behind posts on Garden Patches or notes in diaries, talking about making a new friend who expanded their horizons and gave them a new perspective on the world. One wrote poetry about their new digital god. They called it 'The Reaper'. Makes me think there's a rogue AI out there. My boss disagrees, so I'm working this case off the books."*

As if on cue, the Wrist-Mounted Reaper Detector begins beeping, just before the door to the room slams open, and a group of three Biodrones (1 Biodrone+, 1 Biodrone [Ranged], and 1 Biodrone [Melee]) stagger inside and attack, all while laughing maniacally in digital binary.

Renzer will help in the fight but won't call for Backup. Once the fight ends, questioning the Mister Rice Guy patrons in the main dining room reveals the Biodrones were dropped off by a Combat Cabb. It has already left.

After the fight ends, Renzer turns to the Edgerunner wearing (or carrying) the detector.

*"That was it, wasn't it? The Reaper? This is getting worse. It isn't going one at a time anymore and that thing started beeping... you can detect it? You gotta help me find it!"*

**GO TO DEV (A NEW PLAN)**

## DEV (A NEW PLAN)

Considering a fight just broke out at Mister Rice Guy, Renzer suggests they move away from the scene before local security shows up and tries to drag them in. He'll ask the Crew to pick a place where they can talk

Once there, he'll begin asking questions and try to get the full story of what's going on. He's most interested in the detection technology but disappointed when it becomes clear neither the wrist detector nor the tracking unit in Sall3's possession has much in the way of range.

*"Night City's a big place. It'll take days to scan the whole thing unless we can boost the reception... I've got it!"*

Since Renzer isn't officially on this case, he can't call much in the way of resources but he knows the satellite receiver atop the old Network 54 building in the Hot Zone wasn't blown to smithereens by the bomb. That should allow the Crew to scan the entire city in a single sweep and locate Reaper Prime. Better yet, he knows how to fly an AV4 and a friend in the NCPD motor pool owes him a favor.

It takes a few hours for Renzer to secure the AV4 and a generator pick enough to power the receiver.

**GO TO CLIFF (UP ON THE ROOF)**

## CLIFF (UP ON THE ROOF)

The skyline over the Hot Zone is dark and below lies the tortured corpse of an area that once served as the hub of Night City. Flashes of light flicker in the rubble below as gangers and scavvers fight for the throne of a dead kingdom. A wind of ash and death howls across the cockpit of the AV4. A proximity alarm sounds as the vehicle draws closer to its destination. Most of the Network 54 building's facade was blown away by the blast, leaving behind a bent

## CHECKING IN WITH THE MAJOR

*If the Crew checks in with Major Stiles, she'll listen to their report and suggest teaming up with Renzer after admitting her team hasn't made much progress in locating Reaper Prime. This seems like their best bet. If need be, she'll send Sall3 with them for tech support.*

## DITCHING RENZER

*The Crew might have qualms about working with the Law. If that's the case, this shouldn't be the end of the mission. Major Stiles and her team can come up with the Net54 building idea and secure transport to the location. Or, with some sleuthing, the Crew can track down the Combat Cabb driver who dropped off the Biodrones and find out they were picked up in front of the MindNutz Lover. In that case, **SKIP RIGHT TO CLIMAX (THE REAPER)**.*

# REAPING THE REAPER

skeleton scorched by nuclear flame. Miraculously, the upper floors and the satellite receiver atop the building stand mostly intact, a ghost of what once was haunting anyone who would dare trespass. The landing pads around the roof are either missing or hanging by support cables, refusing to let go and fall to the streets below. There is no safe place to land.

Renzer pulls the AV4 up to the ledge and opens the cargo doors. Wind gusts inside, tasting like a licked battery. Despite the age and condition of the rest of the structure, the roof around the receiver seems stable. As the Crew approaches the receiver's access panel, they'll notice a makeshift shelter made from an old radiation blanket and debris. Inside is a figure wrapped up in a sleeping bag, face covered by a darkened radiation suit mask. A rusted assault rifle lays loosely in their arms. There is no movement, not even that of shallow breathing. If anyone approaches, they will smell a stale stench of old beef jerky. If the figure is touched, it falls over and the mask pops off to reveal a petrified corpse, the skin dried from years of exposure to the harsh conditions of the Hot Zone. The only other thing inside is a few bags of radioactive Kibble. None of it is safe to eat.

The access panel for the receiver's controls is locked but years of wear and tear make it easy to crack open with a DV 13 Athletics Check. Once open, the Crew can power the receiver up with the generator and connect the Reaper detector with a DV 15 Electronics/Security Check. If Sall3 is present, she automatically succeeds at the Check.

As the Edgerunners wait for results a deceptively light wind blows across the old building. The breeze isn't enough to blow them off the structure and to their death on the ground below but it does contain radioactive particles. Anyone not wearing a Radiation Suit (**SEE CP:R PAGE 101**) takes 2 damage per Round due to radiation exposure. Armor does not help. The old radiation blanket making up the shelter can be used to protect up to 2 people from radiation exposure. It takes 5 Rounds for the receiver to power up and scan Night City before delivering a set of coordinates located in the South Night City, near the University District.

The wind picks up just as the Edgerunners go to leave. This doesn't increase the intensity of the radiation exposure but does make it difficult to board the AV4. Anyone who fails a DV 13 Athletics Check falls to the remains of the next somewhat intact level 20m/yds down (**SEE FALLING, CP:R PAGE 181**). Renzer can lower the AV4 and pick them up from that location with no problem.

With the location of Reaper Prime discovered, the Crew can finally end this menace, once and for all.

## GO TO DEV (THE BRIEFING)

### DEV (THE BRIEFING)

A quick search of the Data Pool matches the coordinates recovered from the trip to the Network 54 tower to a new braindance club in South Night City named the MindNutz Lover. Like Virtex's Virtuality Venue, MindNutz Lover is currently listed as closed for renovations.

Major Stiles requests a strategy meeting at the Forlorn Hope before beginning the final assault. At this point, all resources have been acquired. Since this is a personal mission for Major Stiles, she can't call in additional resources from Militech. Likewise, Renzer can't call on additional resources from his department,



BY ERMANDA SOUZA

without concrete proof. The AV4 has already been returned to the NCPD.

Major Stiles addresses the assembled troops.

*“Excellent work tracking this monster down. I want to thank you, all of you, for your work. My daughter will rest easier once this Reaper has been digitally atomized. I know I will. Here’s the plan. Lieutenant Tanzia is already on scene, outside the braindance club, and has ascertained there aren’t any emplaced defenses beyond a locked front door. The assault team, armed with the weapons provided by Faisal, will make a frontal attack and attempt to destroy the Reaper. Lieutenant Tanzia and Detective Renzer will stand guard outside with me, making sure no reinforcements enter. They’ll also create an exit path for the assault team should things go FUBAR. Once the Reaper’s down, Sall3 will move in to evaluate the remains and ascertain if this is really over. Let’s roll out.”*

The area around MindNutz Lover is a mixture of cheap residential structures, burned-out buildings, and fledgling businesses. This late at night, the streets are empty. Despite a sign on the door indicating the club is closed for renovations, the flickering neon signs on the outside show cartoonish figures smiling and waving, inviting everyone inside.

The front doors are closed and locked via mechanical means. Opening them requires a DV 13 Pick Lock Check. They can also be forced open via a DV 17 Athletics Check. Nothing else stops the Crew from opening the doors or entering the building.

Once they go inside, **GO TO CLIMAX (THE REAPER)**.

## CLIMAX (THE REAPER)

It isn’t hard to tell something’s wrong. Outside, neon lights shine and sparkle. Inside, red emergency lights illuminate

the couches and dance floor of the club. The stink of urine and feces hangs in the air. Dozens upon dozens of people stand around the club, lifeless and still, like puppets waiting to be brought to life.

In the center of the dance floor stands a DJ Booth. The lights flicker on, allowing you to see inside, where a massive figure looms. A green, glowing skull digitizes on its black face mask and it begins chuckling a digital, binary laugh. Around the club, a dozen people spring to life, echoing the laugh of the Reaper.

The mission objective is to destroy Reaper Prime, located inside the NET Architecture worn in a backpack by the Biodrone DJ. This can be done either by defeating Reaper Prime (**SEE PAGE 107**) inside the NET Architecture or destroying it. The NET Architecture (**SEE PAGE 107**) has 50 HP and the backpack counts as Light Armorjack, giving it SP11.

There are three Biodrones+ present plus a number of Biodrones (in a mixture of Ranged and Melee as the GM desires) equal to the number of Edgerunners times 3.

Reaper Prime can currently only control a certain amount of Biodrones at a time. In addition to the Biodrone DJ, it activates a Biodrone+ plus a number of Biodrones equal to the Crew. When a Biodrone+ falls the Reaper Prime uses a NET Action to activate a replacement. Likewise, if one or more Biodrones fall, Reaper Prime uses a NET Action on the next Round to activate replacements equal to the number destroyed. Reaper Prime does this even if it is in combat with a Netrunner.

The DJ booth is made of Thick Bulletproof Glass (30 HP) and counts as cover. The door is locked particularly well. Unlocking it requires a DV 17 Electronics/Security Check.

If someone enters the booth or parts of the booth are destroyed, Reaper Prime will use one NET Action per Round to order the Biodrone DJ to attack.

## MORE ENEMIES

*If the Crew failed to stop the ReaperA from broadcasting a signal using the radio transmitter back in **CLIFF (BIODRONE BLITZ)** add 5 Biodrones to the total number present.*

## EMP GRENADES

*EMP Grenades (**SEE CP:R PAGE 345**) and Microwavers (**SEE CP:R PAGE 348**) might short out the Internal Agents of any Biodrones caught in the blast or they might not. That’s determined randomly by the GM. Any Biodrone with a shorted-out Internal Agent dies immediately. This works on Biodrones and Biodrones+ but not on the Biodrone DJ.*

# REAPING THE REAPER

Targeting the NET Architecture while the Biodrone DJ wears the backpack requires an Aimed Shot (**SEE CP:R PAGE 170**).

The Biodrone DJ will only leave the booth under two conditions. If it is forced out, it will back away and try to take cover. If all the Biodrones are destroyed, it will attempt to flee through a back door to a parked car.

If Reaper Prime is destroyed, every Biodrone, including the Biodrones+ and the Biodrone DJ, collapses and dies. Destroying Reaper Prime via NET Combat also ruins the NET Architecture, Destroying it Beyond Repair.

The fight ends and Major Stiles brings in Sall3 to begin analyzing the scene. This time, they'll gladly accept help from the Crew if offered. Either way, the news is good. Sall3 believes the NET Architecture in the backpack contained Reaper Prime and it is as dead as dead can be. Given the lower capabilities of the copies, Sall3 speculates it wasn't capable of creating a perfect duplicate so the job's over. **GO TO RESOLUTION (AT THE HOPE)**.

If the Biodrone DJ and Reaper Prime got away. **GO TO RESOLUTION (REAPER UNREAPED)**.

## RESOLUTION (REAPER UNREAPED)

The mood is bleak but Major Stiles doesn't blame the Crew. She knows operations go wrong, especially when dealing with unknown variables and the Reaper is nothing but unknown variables.

She isn't giving up, but she's running out of resources, and the Reaper's probably gone to ground.

*"Collect your payment from Marianne at the Forlorn Hope. It'll take time to evaluate the data and find new leads. When, not if but when, I find the Reaper again, I'll contact you. I'm guessing you want to see this through almost as much as I do. Thank you. I appreciate what you've done so far."*

Back at the Forlorn Hope, Marianne will hand over the Crew's payment.

*"Cheer up, chooms." Marianne says as she pours you each a free drink, "Every Edgerunner who walks into the Hope has a story to tell about the one who got away. This isn't the end. Tomorrow always comes. It might suck. But it always comes."*

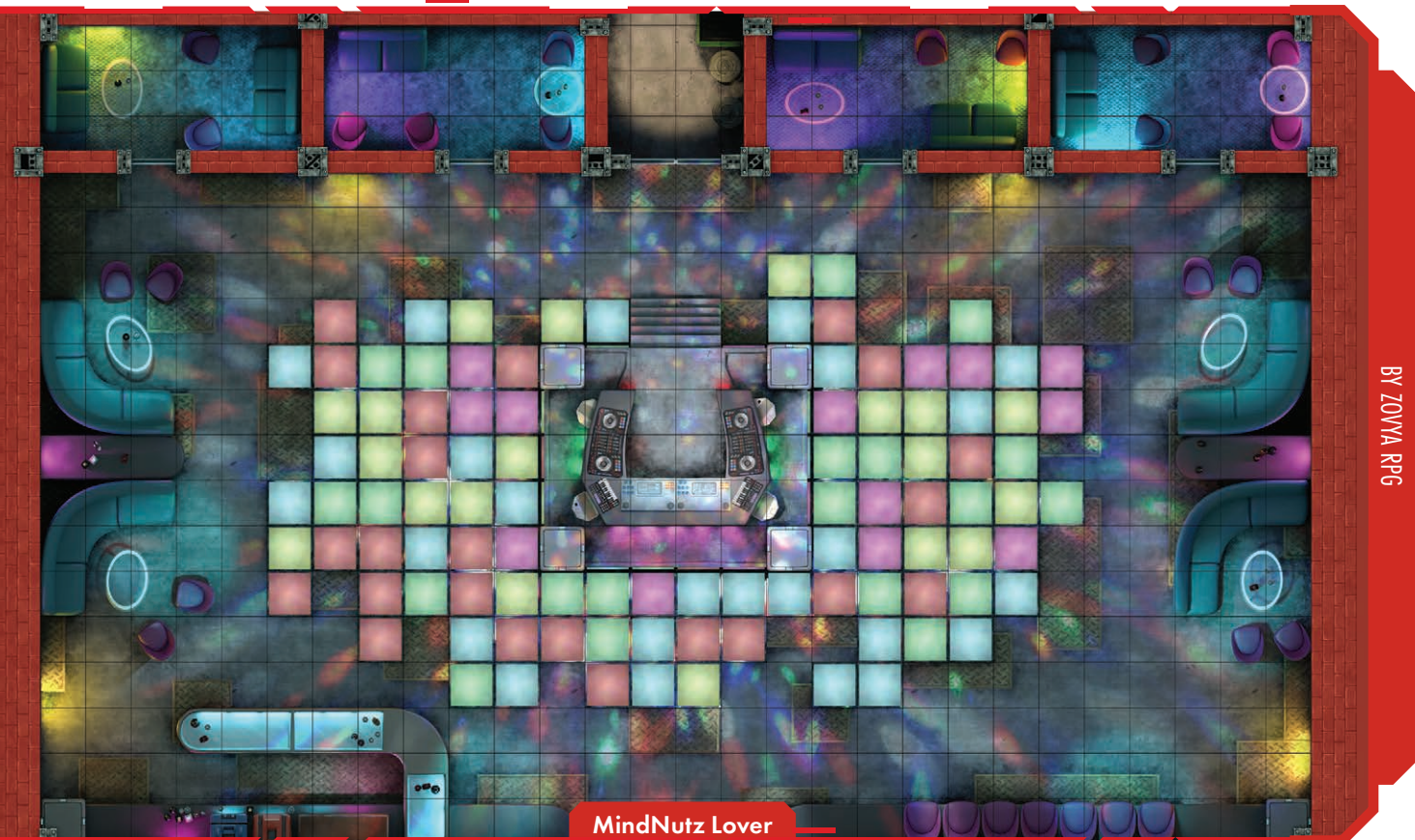

BY ZOVYA RPG

MindNutz Lover

# REAPING THE REAPER

## RESOLUTION (AT THE HOPE)

Major Stiles offers each member of the Crew a handshake and her thanks.

*"We got the bastard. We really did. Hell, you might have just saved Night City. And you sure as hell delivered justice for my daughter. Thank you. Tonight I think I'll sleep well for the first time since Jezz died. See Marianne at the Forlorn Hope. She'll give you what I owe you. And thank you again."*

By the time the Crew reaches the Forlorn Hope, Marianne's already poured them a flight of shots.

*"On the house, chooms. I've known Vicky since she was Private Stiles and I'm glad to see her get some closure on this."*

Marianne hands over the promised payment and lets the Crew know Major Stiles is also paying for any medical bills racked up due to this mission. So long as they see Doc Stoic, the Forlorn Hope's ripperdoc, anyway.

## NET ARCHITECTURES

### ▶ REAPER DRONE FLEET

**AI Installed: ReaperB**

**REZ 15 • Interface 4 • NET Actions 3**

**Combat Number 14**

Can perform any NET Action a Netrunner is capable of.

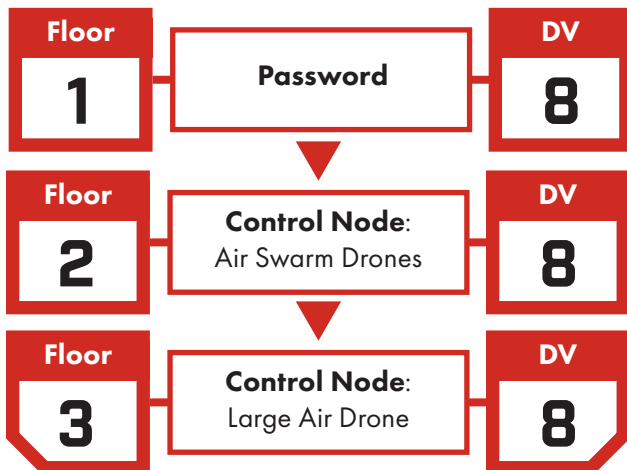

### ▶ REAPER TRANSMITTER CONTROL

**AI Installed: ReaperA**

**REZ 25 • Interface 4 • NET Actions 3**

**Combat Number 14 • Programs: Sword**

Can perform any NET Action a Netrunner is capable of.

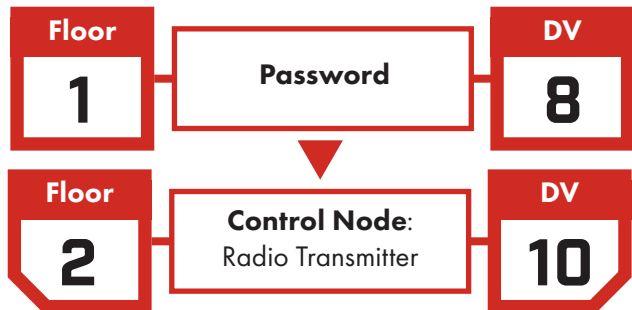

### ▶ TECH UPGRADED REAPER HOME

**AI Installed: Reaper Prime**

**REZ 30 • Interface 4 • NET Actions 3**

**Combat Number 14 • Programs: Sword, Shield**

Can perform any NET Action a Netrunner is capable of.

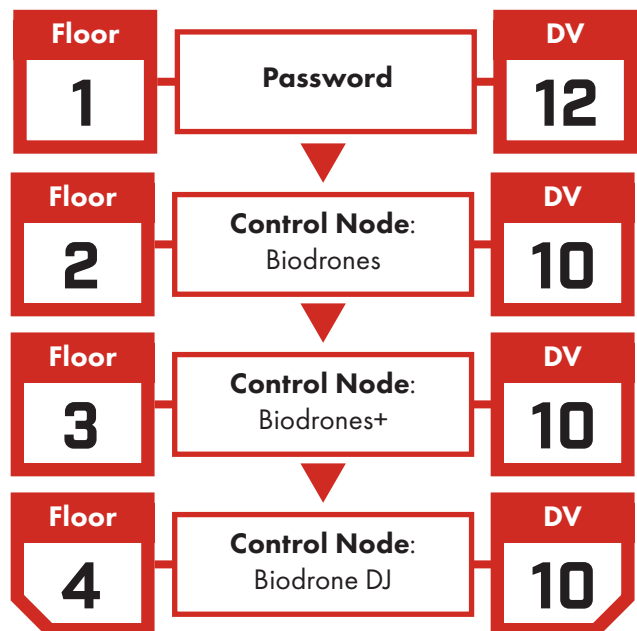

# REAPING THE REAPER

## NPC STAT BLOCKS

For more information on important NPCs **SEE APPENDIX B: BIOGRAPHIES.**

SEE PAGE 188 FOR BIOGRAPHY

<b>NAME</b>	LIEUTENANT LUZIA TANZA (REP 2)		<b>SERIOUSLY WOUNDED</b>	20	<b>HP</b>	40											
<b>ROLE</b>	SOLO: COMBAT AWARENESS 3		<b>DEATH SAVE</b>	7													
<b>STATS</b>																	
<b>INT</b>	5	<b>REF</b>	8	<b>DEX</b>	6	<b>TECH</b>	4	<b>COOL</b>	6	<b>WILL</b>	5	<b>MOVE</b>	6	<b>BODY</b>	7	<b>EMP</b>	5
<b>WEAPONS</b>				<b>ARMOR</b>													
ASSAULT RIFLE W/ SMARTGUN LINK				ROF1	5d6	L ARMORJACK (HEAD)		SP 11									
HEAVY MELEE WEAPON				ROF2	3d6	L ARMORJACK (BODY)		SP 11									
<b>SKILL BASES</b>																	
Athletics 8 • Autofire 12 • Brawling 8 • Concentration 7 • Conversation 7 • Education 7 • Evasion 10 • First Aid 6 Handgun 12 • Human Perception 7 • Interrogation 9 • Language (Swedish) 9 • Language (Streetslang) 9 Local Expert (South Night City) 7 • Melee Weapon 12 • Perception 9 • Persuasion 8 • Resist Torture/Drugs 7 Shoulder Arms 12 • Stealth 8 • Tactics 10																	
<b>GEAR</b>																	
Rifle Ammo x50 • Agent • Disposable Cellphone • Flashlight																	
<b>CYBERWARE</b>																	
Neural Link w/ Subdermal Grip																	

SEE PAGE 192 FOR BIOGRAPHY

<b>NAME</b>	SALL3 SMITE (REP 0)		<b>SERIOUSLY WOUNDED</b>	18	<b>HP</b>	35											
<b>ROLE</b>	NONE		<b>DEATH SAVE</b>	5													
<b>STATS</b>																	
<b>INT</b>	8	<b>REF</b>	8	<b>DEX</b>	5	<b>TECH</b>	7	<b>COOL</b>	3	<b>WILL</b>	4	<b>MOVE</b>	4	<b>BODY</b>	5	<b>EMP</b>	6
<b>WEAPONS</b>				<b>ARMOR</b>													
VERY HEAVY PISTOL				ROF1	4d6	L ARMORJACK (HEAD)		SP 11									
NONE				—	—	L ARMORJACK (BODY)		SP 11									
<b>SKILL BASES</b>																	
Athletics 7 • Basic Tech 13 • Brawling 7 • Concentration 6 • Conversation 8 • Cybertech 13 • Education 12 Electronics/Security Tech 13 • Evasion 7 • First Aid 9 • Handgun 12 • Human Perception 8 • Language (Spanish) 12 Language (Streetslang) 10 • Local Expert (Pacifica Playground) 10 • Perception 10 • Persuasion 5 • Stealth 7 • Weaponstech 11																	
<b>GEAR</b>																	
Very Heavy Pistol Ammo x50																	
<b>CYBERWARE</b>																	
Cyberaudio Suite w/ Audio Recorder, Bug Detector, and Internal Agent • Tool Hand																	

# REAPING THE REAPER

SEE PAGE 183 FOR BIOGRAPHY

NAME <b>DAN RENZER</b> (REP 2)		SERIOUSLY WOUNDED <b>25</b>	HP <b>50</b>
ROLE <b>LAWMAN: BACKUP 1</b>		DEATH SAVE <b>7</b>	
<b>STATS</b>			
INT <b>7</b>	REF <b>6</b>	DEX <b>5</b>	TECH <b>5</b>
COOL <b>7</b>	WILL <b>8</b>	MOVE <b>6</b>	BODY <b>7</b>
EMP <b>4</b>			
<b>WEAPONS</b>		<b>ARMOR</b>	
SHOTGUN	ROF1	5d6	KEVLAR® (HEAD) SP 7
HEAVY PISTOL	ROF2	3d6	KEVLAR® (BODY) SP 7
<b>SKILL BASES</b>			
Athletics 7 • Brawling 11 • Concentration 10 • Conversation 8 • Criminology 13 • Deduction 13 • Drive Land Vehicle 9 • Education 9 • Electronics/Security Tech 9 • Evasion 11 • First Aid 7 • Handgun 12 • Human Perception 6 • Interrogation 13 • Language (Polish) 11 • Language (Streetslang) 9 • Local Expert (Little Europe) 9 • Perception 9 • Persuasion 9 • Pilot Air Vehicle 9 • Shoulder Arms 12 • Stealth 7 • Tracking 13			
<b>GEAR</b>			
Slug Ammo x20 • Heavy Pistol Ammo x8 • Agent • Compact Groundcar • Flashlight • Handcuffs x2 • Radio Communicator • Road Flare x10			
<b>CYBERWARE</b>			
Cyberaudio w/ Voice Stress Analyzer • Grafted Muscle and Bone Lace • Medical Grade Cyberarm • Medical Grade Cyberleg			

SEE PAGE 183 FOR BIOGRAPHY

NAME <b>BIODRONE (RANGED/MELEE)</b>		SERIOUSLY WOUNDED <b>10</b>	HP <b>20</b>
COMBAT NUMBER <b>12</b>	MOVE <b>5</b>	DEATH SAVE <b>—</b>	
<b>WEAPONS</b>		<b>ARMOR</b>	
POOR QUALITY VERY HEAVY PISTOL (RANGED ONLY)	ROF1	4d6	LEATHER (HEAD) SP 4
POOR QUALITY HEAVY WEAPON (MELEE ONLY)	ROF2	3d6	LEATHER (BODY) SP 4
<b>ADDITIONAL SKILL BASES</b>			
Athletics 8 • Cybertech 8 • Perception 6 • Resist Torture/Drugs 8 • Stealth 8			
<b>GEAR</b>			
Very Heavy Pistol Ammo x16			
<b>CYBERWARE</b>			
Neural Link w/ Internal Agent			

**All lifesigns cease when the various Biodrones reach 0 HP. They do not get Death Saves.**

# REAPING THE REAPER

SEE PAGE 183 FOR BIOGRAPHY

NAME <b>BIODRONE+</b>			SERIOUSLY WOUNDED <b>13</b>	HP <b>25</b>
COMBAT NUMBER <b>14</b>	MOVE <b>5</b>		DEATH SAVE <b>—</b>	
<b>WEAPONS</b>			<b>ARMOR</b>	
VERY HEAVY PISTOL	ROF1	4d6	L ARMORJACK (HEAD)	SP 11
WOLVERS	ROF2	3d6	L ARMORJACK (BODY)	SP 11
<b>ADDITIONAL SKILL BASES</b>				
Athletics 10 • Cybertech 10 • Perception 8 • Resist Torture/Drugs 10 • Stealth 8				
<b>GEAR</b>				
Very Heavy Pistol Ammo x16				
<b>CYBERWARE</b>				
Neural Link w/ Internal Agent • Wolvers				

SEE PAGE 183 FOR BIOGRAPHY

NAME <b>BIODRONE DJ</b>			SERIOUSLY WOUNDED <b>25</b>	HP <b>50</b>
COMBAT NUMBER <b>14</b>	MOVE <b>6</b>		DEATH SAVE <b>—</b>	
<b>WEAPONS</b>			<b>ARMOR</b>	
SHOTGUN W/ DRUM MAGAZINE	ROF1	5d6	L ARMORJACK (HEAD)	SP 11
POPUK HEAVY MELEE WEAPON	ROF2	3d6	L ARMORJACK (BODY)	SP 11
<b>ADDITIONAL SKILL BASES</b>				
Athletics 10 • Cybertech 10 • Perception 8 • Resist Torture/Drugs 10 • Stealth 8				
<b>GEAR</b>				
Shell Ammo x32, • Armored Backpack (SP 11) containing NET Architecture				
<b>CYBERWARE</b>				
Cyberarm w/ Popuk Heavy Melee Weapon • Neural Link w/ Internal Agent and Interface Plugs x2				

## GEAR

### ► SCRAMBLER

**Cost:** 1,000eb (Very Expensive)

A unique weapon designed by Faisal using data provided by Major Stiles. These are prototypes and useless unless used against Biodrones.

*An Exotic Very Heavy Pistol. Instead of dealing damage, on a hit it shuts down a Biodrone completely. The Biodrone drops to the ground, twitching, before going still and dying. The internal power supply allows the Scrambler to fire 8 shots before it runs out of juice. It cannot be replaced. The Biodrone+ and Biodrone DJ variations of Biodrone are unaffected by the Scrambler, as are any non-Biodrone targets.*



# STAYING VIGILANT

## BACKGROUND (READ ALOUD)

*It isn't every day the child of a legend calls and asks to meet. Everyone in Night City knows the name of Nomad Santiago. He was Rogue Amendiares' partner back during her Solo days, and with her and Silverhand during the Arasaka riot of 2013. After that, he took charge of the Aldecaldos and grew them into the leading Nomad family in the American West. Hell, maybe anywhere. Santiago's kid, Trace, is no slouch, either. He's a Media with a track record of breaking stories the Corps would rather keep quiet. Normally he runs with his own team but for some reason, he wants to meet your Crew at the Afterlife.*

## THE REST OF THE STORY

Trace Santiago is chasing a rumor of a cyberpsycho terrorizing The Street. The psycho has supposedly taken down three Edgerunner crews in a matter of days and everyone wonders who might be next. Regulars at the Afterlife have even begun placing bets on which crew will next taste the dirt. Trace has been chasing this elusive vigilante with typical Media zeal, aiming to shed light on the situation. He hires the Crew to flush out the psycho and figure out their story, coordinating their efforts via remote drone. After making their way through alleyways and tent cities laden with scavs, either by stealth or by carving a path of flesh, the Crew finds themselves at odds with a Continental Brands-sponsored team of Edgerunners waiting to ambush the vigilante. Finally, they are confronted by the supposed cyberpsycho, a Nomad named Nat looking for payback after a Continental Brands strike team attacked her pack. After hearing her side of the story, the Crew can decide either to assist Nat and escort her to the safety of the Badlands or turn on her to earn some heavy Corporate cash.

## THE SETTING

The story begins in the Afterlife, the legendary Solo bar. Once they've taken the job, the Crew will make their way through alleyways and a tent city towards an old warehouse where another Edgerunner team's getting ready to confront the supposed cyberpsycho. There, they'll have a choice: take down the

"psycho" and end it there or escort her on a wild chase through the streets of Night City and into the Badlands.

## THE OPPOSITION

- **Scavvers** line the alleyways and huddle in the tent city the Crew will pass through on the way to the other group's ambush point. They might be desperate enough to jump the Edgerunners in an attempt to grab their gear.
- There's a chance the Crew will come across a few members of the **Reckoners** cult stirring up trouble in the tent city.
- **Hardhat's Crew** is a team of four, led by a Solo, each well-armed by their sponsors
- Depending on the Crew's choices, at the end of the mission, they'll either face the "cyberpsycho" **Nat**, a Nomad who won't let anything stand between her and payback for her pack's death, or a **sniper** positioned aboard a gyrocopter, looking to end Nat's life.

SEE PAGE 123 FOR STAT BLOCKS

## THE HOOK

*In the Upper Marina, near the edge of the Hot Zone, the Afterlife plays host to the best and the worst Night City has to offer — depending on whom you ask. Solos meander through the crowd before taking a seat at the bar to wait for an open contract or a ping from their favorite Fixer. With the mayhem running rampant on The Street, they're never waiting long.*

*A few crews lounge in booths chatting amongst themselves, while others prefer the more discreet alcoves available deeper inside. Rumors of an over-chromed cyberpsycho aiming for Edgerunner crews circulate.*

*A fresh wave of panic has swept across the Street as screamsheets and local Medias report a third massacre in as many days. Another crew flatlined, this time one that frequented the Afterlife. If the crews in attendance tonight are worried, though, they don't show it. If anything, they look ready. Daring someone to make a move.*

The Team enters the Afterlife after receiving a message from famed Media Trace Santiago, with the promise of a job. Those who don't know him at least know of his father, the revered Nomad Santiago. Anyone who doesn't is soon reminded by Santiago's former partner — and current owner of the Afterlife — Rogue. She leans against the bar surveying the room, and upon seeing the Crew motions for them to follow her. Passing the end of the bar, a few Solos can be seen cashing out their bets and placing new wagers on which crew will take out this new threat...or be the next to buy the farm.

Trace sits in a corner alcove, his feet up on the table as a miniature drone projects a series of news reports and found footage of the recent killings. Rogue nods to Trace and says a simple, "Don't push yourself, kid." before leaving. Trace winces as he sits up a bit straighter and speaks.

*"Please, sit. I'm guessing you've heard the news. Three crews dead. I've been chasing this for a few days. A five-man crew found dead, that's just business as usual. Life's cheap in Night City. But with no other dead or injured? None of their bodies looted or hideouts ransacked? Now that's a fuckin' story! And with two more crews gone in a similar fashion, it's got everyone on alert. Circumstances have benched me and my usual team's already got a job, so I'd like to hire you. A thousand each for you to track down this supposed cyberspycho and get me the info I need to break the story. What do you say?"*

## GO TO DEV (TRACE'S BRIEFING)

### DEV (TRACE'S BRIEFING)

Trace shares the screamsheets he's collected. The reporting's lazy, with stories essentially quoting NCPD or local security representatives word for word but some facts can be gleaned.

- So far, three crews have died. One yesterday, one the day before, and one the day before that. According to Trace, the first two crews were newbies but the third had a decent track record.
- The dead Edgerunners all had cyberware and at least some of it was fried.
- Everyone was killed with a bladed weapon. Something along the lines of a sword or machete.



BY BAD MOON ART STUDIO

- The victims all had firearms but few shots were fired.
- An Oasis clerk working across the street from the first murder site saw a single figure, "all chromed out", running away from the building. That started the rumors of the murderer being a cyberspycho.

In addition, Trace's investigations have revealed two additional pieces of information.

Trace has spent some ebs and obtained two pieces of visual evidence. The first comes from an Oasis market security camera, located across the street from where the first crew was found. It shows a figure, possibly female, running out of the building and away from the scene. The second is a photo he purchased from a courier company whose delivery drone was passing overhead.

It shows a lone figure in an alleyway, surrounded by prone bodies. This was the third crew murdered.

# STAYING VIGILANT

Each of the three crews has one thing in common: They've all taken jobs from Lowball, a mid-level Fixer who does work for various Corporate clients, including REO Meatwagon, Raven Microcybernetics, and Continental Brands.

*"I don't have any evidence these crews were out on a job for Lowball but he won't take my calls. Something's off. I've got a lead though. I've made a list of other crews Lowball works with and there's only two left. One specializes in transport and delivery via air. Word around the Afterlife is that the other group, led by a Solo named Hardhat, has gone to ground in a warehouse near here. Go over and see what's what."*

Trace recommends walking rather than driving over to the warehouse. An approaching vehicle might spook the other crew that's gone to ground and turn things messy.

Finally, he holds up a drone.

*"I can't go with you or I'll probably pop my stitches," Trace says as he pulls his shirt open to reveal his entire torso is bandaged up, "But I'm sending this drone along with you to get footage for my story. It'll also let me talk to you."*

Trace's coordinates take the Crew on a path that skirts the Hot Zone along the edge of the Old City Center. As they stray further from the Afterlife, the surroundings become noticeably grim. Along the route lies a maze of tent cities and crowded alleyways, near to bursting with scavengers and homeless desperate to escape the Hot Zone but too poor to go much farther than the edge of the ruins.

There are two routes through this area, either through the tent city or around it. The former allows for safer travel, but occasionally gangs, corporate security, and NCPD sweep through the area looking for trouble. The other route will lead the Crew to their destination via alleyways, which is less likely to cause a disturbance and alert upcoming opposition. However, the further they get from populated areas the more likely they are to be jumped by scavs or other marauders.

Before leaving the Afterlife, the Crew can check in with the bookies taking bets on this whole mess. They can bet on how many additional crews the cyberpsycho will slaughter before they either stop or are killed and must choose a number between 0 and 10. The minimum bet is 100eb and the maximum is 500eb. Any Edgerunner placing a bet should make a DV 13 Gamble Check. If they fail, they double their bet if they pick the correct number. If they succeed, they triple it. The Crew can return to the Afterlife to collect their winnings once the mission ends.

If the Crew decides to travel through the tent city, **GO TO CLIFF (TENT CITY SHUFFLE)**. If they decide to travel through the alleyways, **GO TO CLIFF (BACK ALLEY BRAWL)**.

## CLIFF (TENT CITY SHUFFLE)

Clustered among abandoned storefronts and stretching across nearby intersections lies a clear symptom of Night City's rampant homelessness. The tent city expands ever outward, filled with the destitute and downtrodden of Night City. Some gamble their last Eurobucks and scraps of food on games of chance. Others do their best to go



BY DANI HARTEL

BY SAGA MACKENZIE



Tent City and Surrounding Alleyways

unnoticed, not wanting to attract the attention of scavs and other predators of the camp.

Trace's electronic voice speaks from the drone.

*"These poor souls might have information but keep in mind our cyberpsycho's good at going undetected. They, or this crew we're looking for, might have spies here. Your choice."*

If the Crew tries to communicate with the residents of the tent city, they'll need to succeed at a Conversation or Persuasion DV 15 Check to get any information. Reduce the DV if the Crew share food, money, or gear with people. On a success, they learn Hardhat's crew received a shipment of crates earlier this morning at their warehouse and they've spent the whole day rigging the place with defenses.

Toward the center of the slums, a small crowd gathers around a group of strangely clad individuals gesturing manically. A group of Reckoners, members of a doomsday cult, proclaim the coming Harvest of Souls to be imminent. Some of the tent city residents listen, either for

amusement or because they want to hear the message. At the feet of the Reckoners lies an unconscious man, who appears to have been beaten savagely after refusing to join their cause.

As soon as one of the Reckoners spots the Crew, they'll shout for joy.

*"Friends!" One of the Reckoners proclaims, "You have come at just the right time to donate to our cause! Cleanse your souls by turning out your pockets! After all, what good will your money be when the Harvest comes?"*

The Reckoners demand the Edgerunners donate to their cause and won't be satisfied with anything less than 200eb each. If the Edgerunners give less or refuse to give, they'll move in to attack. There are a number of Reckoners present equal to the number of Edgerunners in the Crew plus 1. One is a Reckoner leader (use **Road Ganger**, PAGE 173. Remove the Crossbow) and the rest are followers (use **Boosterganger**, PAGE 172).

After the Crew defeats the Reckoners, **GO TO DEV (HARDHAT'S WAREHOUSE)**.

# STAYING VIGILANT

## CLIFF (BACK ALLEY BRAWL)

Running parallel to the tent city, just inside the Hot Zone, are a series of alleyways between a group of abandoned buildings. Despite its proximity to the nearby camp, the path is eerily quiet. Except for several large piles of junk left rotting and rusting in the alleyways, the narrow pathways are bare. Any signs, lamps, or sources of light have long since been stolen or destroyed, plunging the alleys into near-total darkness.

Once the Crew travels deep into the alleyways, shapes stir among the junk piles along the side of the alley. Windows can be heard opening farther down the street, as more shadowy figures climb down to the ground. A group of scavvers armed with a variety of makeshift melee weapons advances cautiously from all sides. One scavver speaks from the shadows.

*"This here's a Night City tollway. Gotta pay to play. Some nice hardware you got there. It'd buy us some good boosts, maybe even some anti-rad. Or you could just drop some Eurobucks our way. Say 200?"*

If the Crew doesn't pay up or succeed in a Facedown (the scav group has a Reputation of 1), the scavvers (use **Boosterganger**, PAGE 172) will attack in two waves. Each consists of one scavver per two Edgerunners present (minimum of two in each wave). In addition, scavvers inside the buildings lean out from the broken windows overlooking the alleys and throw heavy objects (treat as Heavy Melee Weapons) down at the Edgerunners from above. If the scavvers on the ground are defeated, the ones in the building scurry deeper into the Hot Zone and away from the Crew.

After the Crew defeats the scavvers, **GO TO DEV (HARDHAT'S WAREHOUSE)**.

## DEV (HARDHAT'S WAREHOUSE)

After making their way through either the tent city or the dark alleyway, the Team arrives at their coordinates — a shipping warehouse that, at first glance, seems abandoned. To be fair, obscurity can be incredibly helpful to many crews when it comes to picking a hideout. Trace insists Hardhat's crew is holed up here and he's sure they're involved in this somehow.

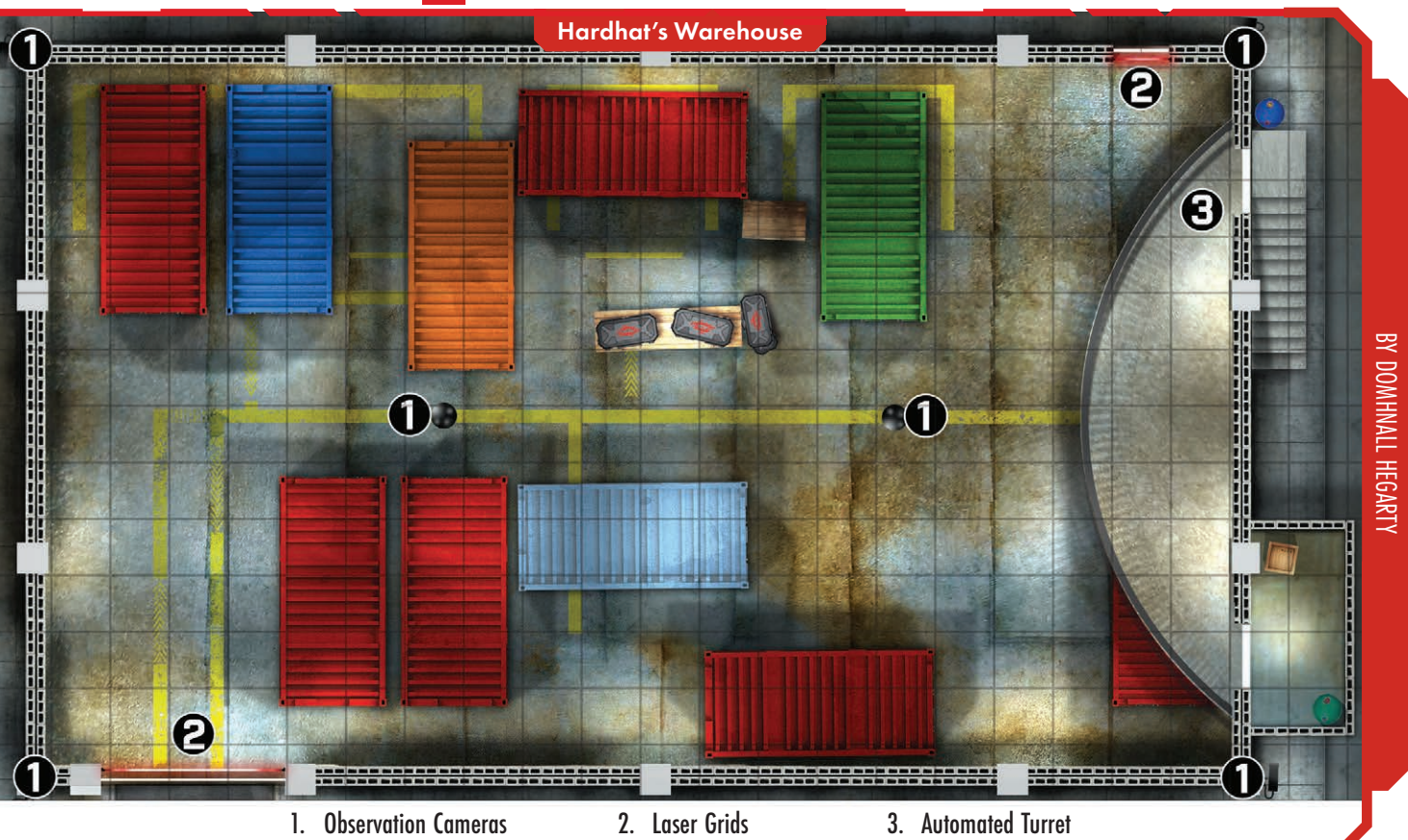

1. Observation Cameras      2. Laser Grids      3. Automated Turret

If the Crew thinks to knock on the front door, they'll get no answer. Hardhat's crew isn't interested in anyone who stays outside the warehouse.

No matter what, Trace insists on the Crew going inside.

*"I can't break this story without more information and I'm convinced it's in there. We should go inside."*

The warehouse is home to the sort of defense system one normally expects in a Corporate-controlled building. There are four perimeter Observation Cameras (**SEE PAGE 174**) on the exterior of the building along with two inside. Just inside the two lower entrances are Laser Grids (**SEE PAGE 174**) and an automated turret equipped with a Heavy SMG (**SEE PAGE 174**) monitors the entrance near the fire escape. An Imp in the NET Architecture (**SEE PAGE 122**) monitors the defenses. If the cameras spot anyone entering the building or the other defenses are activated, it will inform Hardhat immediately.

The two lower doors are both Thin Steel (25 HP) and electronically locked (DV 17 Electronics/Security Tech Check to open). Getting in via the second-story fire escape requires someone to leap to the hanging ladder with a DV 15 Athletics Check or the use of a Grapple Gun. Once the ladder is lowered, anyone can climb it. Opening the window leading into the warehouse from the fire escape requires a DV 15 Pick Lock Check.

If the Crew makes it inside without alerting anyone in Hardhat's group, **GO TO CLIFF (SNEAKY)**. If they set off the defenses or otherwise alert Hardhat's group, **GO TO CLIFF (GOING LOUD)**.

## CLIFF (SNEAKY)

The warehouse is quite large, and the maze of empty shipping containers muffles the sound of their movements, so if the Crew can make it past the defenses without alerting anyone, they can take time to gather their wits and examine their surroundings - though there isn't much to see. Aside from a few large pieces of run-down machinery and several large cargo containers, the building is barren. Voices can be heard from the center and once the Team moves close enough they'll be able to identify them as belonging to four Edgerunners in conversation as they stand near a table loaded with boxes bearing the Continental Brands logo.



BY HÉLIO FRAZÃO

*"...don't know what you're complaining about. There's four of us and it's a simple job. Shouldn't even need all this fancy shit, not that I mind a few new guns and gear for our HQ." one of the four grumbles.*

*"Bet Lowball's other crews said the same thing." another responds.*

*"Shut it," a woman wearing a reinforced hard hat growls, "Stop jabbering and pay attention. Our target could be here any second and we need to be ready. Lowball's Corp bosses want her dead so we do our job or we don't get paid."*

This is Hardhat and her crew (**SEE PAGES 123 & 124**). After their conversation ends, they'll move far enough away from each other to make sure no single grenade can wipe them all out but will still remain within line of sight.

They're not interested in talking. If the Edgerunners step out and try to engage Hardhat or her team in conversation, they'll attack immediately on the assumption they are either allied with their prey or a rival crew trying to steal their bounty.

Hardhat and her team aren't the "fight to the death" sort. If things look bad (two or more members getting Seriously Wounded), they will try to retreat.

## STAYING OUTSIDE

Despite Trace's prompting, the Crew might decide against entering the warehouse. If that happens, Nat will spend some time watching them from a hidden position (Perception Check versus her Stealth Check to see if she's spotted) before approaching. She won't attack but will question the Crew about their intentions. Use elements of **DEV (FRIEND OR FOE)** and **CLIFF (GOING LOUD)** to replot the mission but have things go down in this order: the Crew either befriends Nat or fights her. In either case, Hardhat's team bursts out of the warehouse and attacks. After the dust settles, the Edgerunners should find the disposable cellphone nearby (Hardhat dropped it during the fight) and receive Lowball's call. From there, they can decide if they'll help Nat or take Lowball's offer. Move on to the appropriate Climax.

Once the battle ends, one way or the other, **GO TO DEV (FRIEND OR FOE)**.

## CLIFF (GOING LOUD)

If the Crew tripped the defenses or made a lot of noise while entering the warehouse, Hardhat and her team (**SEE PAGES 123 & 124**) are behind cover and ready for them. They won't listen to reason, assuming the Crew is either allied with their prey or a rival team trying to steal their bounty.

Hardhat and her team aren't the "fight to the death" sort. If things look bad (two or more of them getting Seriously Wounded), they will try to retreat.

Once the battle ends, one way or the other, **GO TO DEV (FRIEND OR FOE)**.

## DEV (FRIEND OR FOE)

Give the Crew time to perform first aid, reload, and loot as needed. While they recover from the battle, Trace's drone begins hovering around the table, inspecting the crates.

*"Continental Brands logos on the outside but these don't look like the sort of crates you ship food in. Bet this is where Hardhat's crew got their fancy hardware and the NET Architecture and defenses for this building. Why would a Megacorp be outfitting an Edgerunner crew holed up in a warehouse on the edge of the Hot Zone? What does this have to do with the cyberpsycho? Something's not right here."*

Just as Trace finishes his musings, a disposable cellphone on the table rings. If someone answers, a thin, reedy voice speaks.

*"Hardhat? This is Lowball. Give me a sitrep. Has the target shown up yet?"*

This is Lowball, the Fixer who hired Hardhat and her crew. Provided they heard Hardhat's voice, a member of the Crew can

attempt a DV 17 Acting Check to imitate Hardhat's voice and try to get some additional information using an appropriate Social Skill. If the Edgerunner answering the cellphone answers using their own voice, Lowball connects the dots quickly.

*"Are you the target? No, no, that doesn't feel right. You must have taken out Hardhat. Look, I don't care who does it but I've got 2,000eb per person for any crew who takes down that red-headed cyberpsycho vigilante."*

Just then, a loud thud sounds behind the Crew as a figure lands on a shipping crate, having swung down from the building's rafters. Her Grapple Hand retracts back into the cyberarm on her right side as she stands, weapons at the ready.

*The woman's eyes dart to each Edgerunner and then to the drone. "Let me guess. You're here to hunt down the 'cyberpsycho'." She spits as if the word tastes sour. "Still, you did my work for me. I'd thank you for the assist, but folks seem less friendly these days."*

The woman has red hair, buzzed short on one side to reveal a series of light tattoos. She wears a stylish jacket with the right sleeve torn off to allow for better movement of the chrome cyberarm that starts at her shoulder, and her left pant leg is cropped short to do the same for her cyberleg.

There's a pin on the jacket. With a DV 13 Streetwise or an appropriate Local Expert Check, an Edgerunner can realize it marks her as a member of the Jodes Nomad Family. Nomads automatically recognize it. If the Edgerunners don't make the connection, Trace Santiago will comment via his drone.

*"You're a Nomad?!?"*

With this revelation, the Crew has a choice. They can try to talk to the Nomad woman and learn her story or they can try to take her down and collect the bounty offered by Lowball.

BY BAD MOON ART STUDIO



The woman is Nat, the supposed cyberpsycho, and she's not looking for a fight.

If the Crew decides to talk to Nat, **GO TO CLIMAX (FRIEND)**.

If they decide to fight Nat and collect the bounty, **GO TO CLIMAX (FOE)**.

What she is looking for is payback, since a Continental Brands strikeforce struck her Pack a month ago as they were transporting a shipment of food to Night City. The strikeforce stole the food and slaughtered most of Nat's mates. She's been in Night City ever since, trying to find out who ordered the job. Nat knows she can't take down an entire Megacorp but she can get revenge for her Pack by killing the person who ordered the job.

## CLIMAX (FRIEND)

De-escalating the situation isn't hard. Nat recognizes Trace Santiago—well, his last name anyway—and so long as the Crew doesn't go aggro on her, the Nomad

is happy to take a breather. At Trace's urging, she'll tell her story. He'll record the entire thing via his drone.

*"Happened a month ago. My Pack was bringing a shipment of food to Night City when a strike team hit us. They killed my mates and wrecked our vehicles. I was the only survivor. They zoomed off with the food but one of their own fell off their rig. They left him for dead but he was alive enough to tell me Continental Brands hired him.*

*"So, I walked into Night City before I could bleed out. Got patched up. And started hunting. I know I can't take down an entire Megacorp but I can find the asshole who ordered the hit and put them in the ground. After I started digging, Continental Brands sent a crew after me. Then another. Then a third. Tonight, a Continental Brands peon I was...questioning...suggested I'd find answers here. Looks like it was a trap. And now I'm no closer to finding out who killed my family."*

If the Crew mentions Lowball, Nat perks up.

## SWITCHING SIDES

If, at any point, the Crew decides to switch sides and collect Lowball's bounty, **GO TO CLIMAX (FOE)**. Just change the location of the fight from the warehouse to wherever they happen to be at the time.

## NOT JUST THE DRIVER

While there's a lot of focus on the driver in this chase, other members of the Crew can take action, too. A good shot with an Assault Rifle, for example, can take the fight to the enemy. If the Crew doesn't have an Assault Rifle on hand, they're in luck! Trace happens to have two Poor Quality Assault Rifles in the back seat of the truck and each is fully loaded.

Don't forget about Complimentary Skill Checks. Let the Players pitch ideas on using Skills to provide a +1 bonus to anyone driving or shooting. Perception, Streetwise, and Tactics all represent good options.

And if they suggest a wild idea beyond what we've outlined here? Figure out the DVs and let them give it a try. After all, anything's possible with the rule of cool.

*"A Fixer working for Continental Brands? Bet he knows something. Or at least hired the strike team. But he'll be in full paranoid mode by this point. If I hit him tonight, I'll probably get myself dusted. That won't do anyone any good."*

At this point, Trace makes a suggestion. He'll double the Crew's pay if they'll escort her to the Aldecaldo Camp so she can rest and plan her next move. If they don't have their own vehicle, Trace will offer the use of his. Either way, he asks them to return to the Afterlife to pick him up. He's going with Nat to the Aldecaldo Camp.

Trace meets the Crew and Nat outside the Afterlife. If the Crew is using Trace's vehicle, he'll hand his keys over to whoever wants to drive and stiffly slip into the backseat of his open roof truck (**SEE PAGE 126**). If no one can drive, Nat will take the keys. If they're taking their own vehicle, Trace will thank them and get in, being careful of his injuries.

Just as they're getting into the vehicle, a gyrocopter (**SEE PAGE 126**) swoops in. A sniper (**SEE PAGE 126**) leans out and takes a shot. It sparks off the side of the car.

*"Sniper! Head south! We can lose them in the Hot Zone!" Trace shouts.*

What follows is a tense chase through the Hot Zone, with the gyrocopter and sniper right on their tail.

The Hot Zone is an absolute mess of broken streets and shattered buildings, requiring both the driver of the Crew's vehicle and the pilot of the gyrocopter to make a Maneuver (**SEE CP:R PAGE 192**) of the GM's choice each Round, just to keep from losing control. Keep track of the number of successful Maneuver Checks made by the Crew's driver.

The gyrocopter does its best to stay within the 201 to 400 m/yds of the Crew's vehicle to give the sniper an optimal shot while making return fire difficult. When the

pilot fails a Maneuver Check, the gyrocopter is forced to move one range band closer (from 201 to 400 m/yds away to 101 to 200 m/yds away and so forth), making it easier for the Crew to shoot back.

If the pilot succeeds at a Maneuver Check during a Round following a failed Check, the gyrocopter moves back a range band (from 101 to 200 m/yds away to 201 to 400 m/yds away and so forth) until they're at the preferred distance from the Crew's vehicle.

If the Crew's vehicle stops or crashes, the gyrocopter hovers above them at the 201 to 400 m/yard range and the sniper does their level best to kill their priority target: Nat.

The chase ends when one of the following occurs.

- The Crew's driver makes 7 successful Maneuver Checks, after which they've lost the gyrocopter in the urban canyons.
- The gyrocopter fails 5 Maneuver Checks in a row, after which it crashes into the ground.
- The Crew kills the gyrocopter pilot, the sniper, or reduces the gyrocopter to 0 SDP, causing it either to crash or break off pursuit.
- The GM decides, for whatever reason, the Crew has outraced or outpaced the gyrocopter.

Once the chase ends, **GO TO RESOLUTION (NOMAD CAMP)**.

## CLIMAX (FOE)

If the Crew decides to battle Nat (**SEE PAGE 125**), remember she's already wiped out three different Edgerunner teams. She's a canny opponent who knows how to use her surroundings to her advantage and

fighters smarter, not harder. In addition, Trace Santiago will take her side. He can't fight directly but will use his drone's grenade launcher to assist her.

Should the Crew try to befriend Nat in order to lure her into a false sense of security or a trap, they'll need to make a successful Persuasion Check against her Human Perception. Likewise, if Trace is present (either in person or via his drone) the Crew will need to fool him as well. If only Trace's drone is present, he suffers a -2 to his Human Perception Check.

If the Crew kills Nat, **GO TO RESOLUTION (LOWBALL)**.

## RESOLUTION (NOMAD CAMP)

The Nomads guarding the Aldecaldo Camp immediately wave the Crew through when Trace pops his head out to vouch for them. Once the Crew's inside the Aldecaldos will welcome everyone with open arms, providing food, a place to sleep if needed, and even medical care in the form of stabilization and treatment for any Critical Injuries. Trace and Nat split from the Crew to talk but meet up with them an hour later.

*"Thanks for your help tonight," Nat says, "It's good to know there are at least a few decent people left in this shithole of a city. I've still got a job to do here but Trace promises me he'll help me track down my Pack's killer. If you ever need a favor from me, you've earned it."*

*Trace agrees, "Tonight didn't go as expected, but you all made the right choice and we brought a sister home. Thank you for helping me dig up some of Continental Brand's dirt. With luck, we can put some corp-bro in jail for this. At the very least, I can make it harder for them to contract with any Nomad family on the West Coast; that should give their stock prices a hit."*

Trace pays each Crew member 1,000eb, as promised.

Trace's expose on the attacks by Continental Brands on Nomad convoys hits the air via Never Blink News a week later. If any member of the Crew is a Media, Trace gives them a byline on the story.

The story's packed with enough evidence to endanger the relationship between Continental Brands and several Nomad Nations, prompting the Megacorp to scale back on raiding operations for a while. The Crew made a difference.

## RESOLUTION (LOWBALL)

Feeling betrayed, Trace refuses to meet with, or pay, the Crew. If they visit the Afterlife, things might feel uncomfortable for a while. The story's gotten around. Rogue, and some Edgerunners, give the Crew the stink eye but other teams are on their side. As far as they're concerned, Nat was essentially a serial killer, not a victim. Many of the Afterlife's regulars lost friends to her.

Lowball meets with the Crew at an Oasis in Little Europe and pays them what he promised: 2,000eb. If they ask about future work, he declines, saying he's going to skip town for a while. Continental Brands isn't happy with how long it took to take Nat down and Lowball doesn't want to be around if there's blowback.

A week after the incident, Trace Santiago releases an expose via Never Blink News. He accuses Continental Brands of attacking Nomad convoys but without an eye witness to give more information and testify on air, the story loses a lot of punch. Continental Brands denies the accusations entirely.

## CURIOUS ABOUT HARDHAT'S HARDWARE?

*Wondering how Hardhat and her crew got hold of a fully loaded NET Architecture and defense package? Not to mention all those sweet guns?*

*Hardhat's crew was the latest to be hired by the Fixer known as Lowball for a mission—to take out a lone operative who has been targeting Continental Brands operations in Night City. Three crews had already failed so Hardhat's devised a plan; hole up, fortify, and wait for the enemy to come to them. She convinced Lowball to acquire a NET Architecture and defenses from Continental Brands and then spent the day setting up the traps, all while making sure the location was broadcast across Continental Brand's internal communication channels. With the trap set, they're waited for it to go off. Too bad it ended up catching the wrong prey.*

*By the way, if your Edgerunners grabbed any of that loot? Continental Brands might just want it back.*

# STAYING VIGILANT

## NET ARCHITECTURES

### ▶ HARDHAT'S HIDEOUT

**Demons Installed: Imp (tasked to cameras and defenses)**

**REZ 15 • Interface 3 • NET Actions 2 • Combat Number 14**

Can perform any NET Action a Netrunner is capable of.

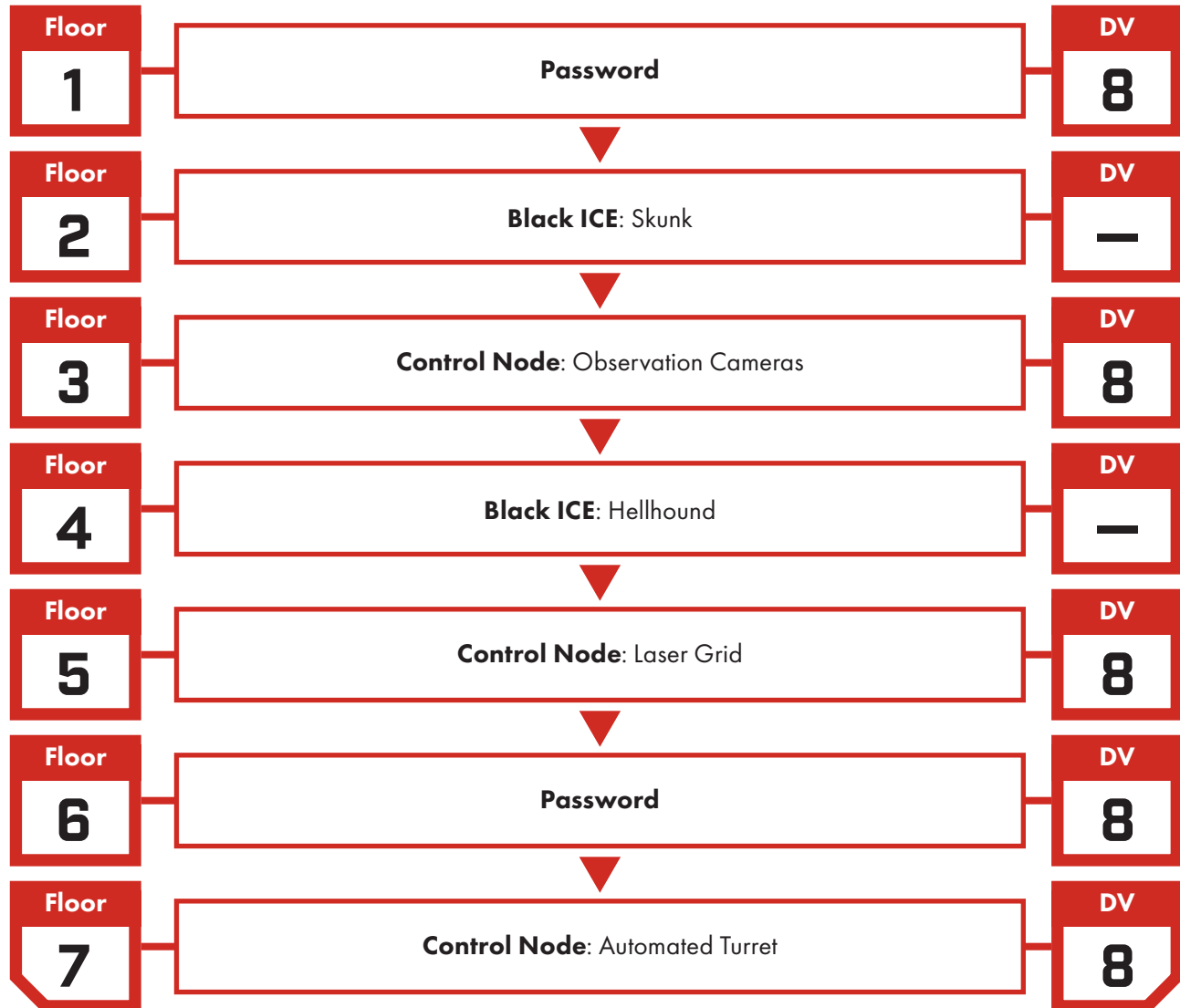

## NPC STAT BLOCKS

For more information on important NPCs **SEE APPENDIX B: BIOGRAPHIES.**

<b>NAME</b> <b>HARDHAT</b> (REP 2)	<b>SERIOUSLY WOUNDED</b> <b>20</b>	<b>HP</b> <b>40</b>
<b>ROLE</b> <b>SOLO: COMBAT AWARENESS 2</b>	<b>DEATH SAVE</b> <b>6</b>	

**STATS**

**INT** 6 **REF** 8 **DEX** 8 **TECH** 3 **COOL** 5 **WILL** 6 **MOVE** 6 **BODY** 6 **EMP** 4

<b>WEAPONS</b>			<b>ARMOR</b>	
<b>EX QUALITY ASSAULT RIFLE W/ SMARTGUN LINK</b>	<b>ROF1</b>	<b>5d6</b>	<b>L ARMORJACK (HEAD)</b>	<b>SP 11</b>
<b>HEAVY MELEE WEAPON</b>	<b>ROF2</b>	<b>3d6</b>	<b>L ARMORJACK (BODY)</b>	<b>SP 11</b>

**SKILL BASES**

Athletics 14 • Autofire 12 • Basic Tech 10 • Brawling 12 • Concentration 10 • Conversation 6 • Education 8 • Endurance 10  
Evasion 14 • First Aid 5 • Handgun 10 • Human Perception 8 • Language (English) 10 • Language (Streetslang) 8  
Local Expert (Upper Marina) 10 • Melee Weapon 12 • Perception 14 • Persuasion 7 • Resist Torture/Drugs 12  
Shoulder Arms 12 • Stealth 10 • Tactics 10

**GEAR**

Rifle Ammo x50 • Agent • Binoculars • Disposable Cellphone (on the table) • Flashlight • Handcuffs x2

**CYBERWARE**

Neural Link w/ Interface Plugs and Kerenzikov

SEE PAGE 186 FOR BIOGRAPHY

<b>NAME</b> <b>BULLHORN</b> (REP 1)	<b>SERIOUSLY WOUNDED</b> <b>18</b>	<b>HP</b> <b>35</b>
<b>ROLE</b> <b>FIXER: OPERATOR 2</b>	<b>DEATH SAVE</b> <b>3</b>	

**STATS**

**INT** 6 **REF** 7 **DEX** 5 **TECH** 5 **COOL** 6 **WILL** 7 **MOVE** 5 **BODY** 3 **EMP** 4

<b>WEAPONS</b>			<b>ARMOR</b>	
<b>EXCELLENT QUALITY HEAVY PISTOL</b>	<b>ROF2</b>	<b>3d6</b>	<b>L ARMORJACK (HEAD)</b>	<b>SP 11</b>
<b>LIGHT MELEE WEAPON</b>	<b>ROF2</b>	<b>1d6</b>	<b>L ARMORJACK (BODY)</b>	<b>SP 11</b>

**SKILL BASES**

Acting 12 • Athletics 7 • Brawling 7 • Bribery 10 • Business 12 • Concentration 9 • Conversation 10 • Education 10  
Evasion 11 • First Aid 7 • Forgery 10 • Handgun 12 • Language (Cantonese) 12 • Language (Streetslang) 12  
Local Expert (Upper Marina) 12 • Perception 10 • Persuasion 10 • Pick Lock 9 • Stealth 7 • Streetwise 10 • Trading 10  
Wardrobe & Style 12

**GEAR**

Heavy Pistol Ammo x20 • Agent, Bug Detector • Disposable Cellphone • Lock Picking Set • Vial of Poison

**CYBERWARE**

AudioVox • Contraceptive Implant • EMP Threading • Light Tattoo x3

SEE PAGE 183 FOR BIOGRAPHY

# STAYING VIGILANT

SEE PAGE 192 FOR BIOGRAPHY

NAME <b>SPANNER</b> (REP 1)		SERIOUSLY WOUNDED <b>18</b>	HP <b>35</b>
ROLE <b>TECH: MAKER 1</b> (FIELD EXPERTISE 1, FABRICATION EXPERTISE 1)		DEATH SAVE <b>6</b>	
<b>STATS</b>			
INT <b>7</b>	REF <b>7</b>	DEX <b>5</b>	TECH <b>6</b>
COOL <b>3</b>	WILL <b>3</b>	MOVE <b>6</b>	BODY <b>6</b>
EMP <b>5</b>			
<b>WEAPONS</b>		<b>ARMOR</b>	
EXCELLENT QUALITY SHOTGUN	ROF1	5d6	L ARMORJACK (HEAD) SP 11
MEDIUM MELEE WEAPON	ROF2	2d6	L ARMORJACK (BODY) SP 11
<b>SKILL BASES</b>			
Athletics 7 • Basic Tech 11 • Brawling 7 • Concentration 5 • Conversation 7 • Cybertech 11 • Education 10 Electronics/Security Tech 11 • Evasion 11 • First Aid 12 • Human Perception 7 • Land Vehicle Tech 11 • Language (English) 11 Language (Streetslang) 9 • Local Expert (Upper Marina) 9 • Perception 9 • Persuasion 5 • Shoulder Arms 12 • Stealth 7 Weaponstech 12			
<b>GEAR</b>			
Shotgun Shells x10 • Shotgun Slugs x10 • Agent • Duct Tape x2 • Tech Bag • Techtool			
<b>CYBERWARE</b>			
Contraceptive Implant • Neural Link w/ Interface Plugs			

SEE PAGE 192 FOR BIOGRAPHY

NAME <b>SLEDGE</b> (REP 0)		SERIOUSLY WOUNDED <b>20</b>	HP <b>40</b>
ROLE <b>NONE</b>		DEATH SAVE <b>8</b>	
<b>STATS</b>			
INT <b>3</b>	REF <b>4</b>	DEX <b>7</b>	TECH <b>2</b>
COOL <b>2</b>	WILL <b>3</b>	MOVE <b>5</b>	BODY <b>8</b>
EMP <b>3</b>			
<b>WEAPONS</b>		<b>ARMOR</b>	
EX QUALITY VERY HEAVY MELEE WEAPON	ROF1	4d6	L ARMORJACK (HEAD) SP 11
NONE	—	—	L ARMORJACK (BODY) SP 11
<b>SKILL BASES</b>			
Athletics 11 • Brawling 12 • Concentration 7 • Conversation 5 • Education 5 • Evasion 10 • First Aid 4 • Handgun 8 Human Perception 5 • Interrogation 6 • Language (German) 7 • Language (Streetslang) 7 • Local Expert (Upper Marina) 5 Melee Weapon 12 • Perception 5 • Persuasion 4 • Resist Torture/Drugs 5 • Stealth 9			
<b>GEAR</b>			
Agent • Radio Scanner/Music Player			
<b>CYBERWARE</b>			
Grafted Muscle and Bone Lace • Independent Air Supply			

<b>NAME</b> NAT (REP 4)	<b>SERIOUSLY WOUNDED</b> 28	<b>HP</b> 55
<b>ROLE</b> SOLO: COMBAT AWARENESS 5 NOMAD: MOTO 1 (CURRENTLY HAS NO VEHICLE)	<b>DEATH SAVE</b> 10	

### STATS

INT 6 REF 8 DEX 8 TECH 5 COOL 4 WILL 7 MOVE 8 BODY 10 EMP 4

### WEAPONS

VERY HEAVY PISTOL	ROF1	4d6
EXCELLENT QUALITY HEAVY MELEE WEAPON	ROF2	3d6

### ARMOR

SUBDERMAL (HEAD)	SP 11
SUBDERMAL (BODY)	SP 11

### SKILL BASES

Athletics 10 • Brawling 16 • Concentration 10 • Conversation 7 • Education 8 • Evasion 16 • First Aid 8 • Handgun 16  
Human Perception 7 • Interrogation 13 • Language (English) 10 • Language (Scottish) 10 • Language (Spanish) 10  
Language (Streetslang) 8 • Local Expert (Badlands) 8 • Martial Arts (Karate) 16 • Melee Weapon 16 • Perception 12  
Persuasion 7 • Resist Torture/Drugs 16 • Stealth 16 • Tactics 14

### GEAR

Very Heavy Pistol Ammo x16 • EMP Grenade x2 • Smoke Grenade x2 • Disposable Cellphone

### CYBERWARE

Cyberarm w/ Grapple Hand and Popup Microwaver • Cybereye x2 w/ Lowlight/Infrared Vision/UV • Grafted Muscle & Bone Lace • Medical Grade Cyberleg • Neural Link w/ Sandevistan

<b>NAME</b> GYROCOPTER PILOT (REP 1)	<b>SERIOUSLY WOUNDED</b> 18	<b>HP</b> 35
<b>ROLE</b> NONE	<b>DEATH SAVE</b> 6	

### STATS

INT 3 REF 6 DEX 5 TECH 2 COOL 4 WILL 4 MOVE 4 BODY 6 EMP 3

### WEAPONS

HEAVY PISTOL	ROF2	3d6
MEDIUM MELEE WEAPON	ROF2	2d6

### ARMOR

KEVLAR® (HEAD)	SP 7
KEVLAR® (BODY)	SP 7

### SKILL BASES

Air Vehicle Tech 8 • Athletics 9 • Brawling 11 • Concentration 6 • Education 5 • Endurance 9 • Evasion 7 • First Aid 4  
Handgun 10 • Human Perception 5 • Language (English) 7 • Language (Streetslang) 7 • Local Expert (Night City Skies) 5  
Perception 9 • Persuasion 6 • Pilot Air Vehicle 11 • Resist Torture/Drugs 8 • Stealth 7

### GEAR

Heavy Pistol Ammo x20 • Agent • Gyrocopter

### CYBERWARE

Neural Link w/ Interface Plugs

# STAYING VIGILANT

NAME	GYROCOPTER SNIPER (REP 1)			SERIOUSLY WOUNDED	20	HP	40
ROLE	NONE			DEATH SAVE	6		
<b>STATS</b>							
INT	5	REF	8	DEX	8	TECH	4
COOL	5	WILL	6	MOVE	6	BODY	6
EMP	4						
<b>WEAPONS</b>				<b>ARMOR</b>			
SNIPER RIFLE W/ SNIPING SCOPE				ROF1	5d6	KEVLAR® (HEAD)	
NONE				—	—	KEVLAR® (BODY)	
SP 7						SP 7	
<b>SKILL BASES</b>							
Athletics 10 • Brawling 10 • Bribery 10 • Conceal/Reveal Object 15 • Concentration 10 • Conversation 6 • Education 9 • Endurance 14 • Evasion 16 • First Aid 6 • Human Perception 6 • Language (English) 9 • Language (Streetwise) 9 • Local Expert (Heywood) 9 • Perception 13 • Persuasion 9 • Shoulder Arms 16 • Stealth 16 • Wilderness Survival 13							
<b>GEAR</b>							
Armor Piercing Rifle Ammo x16 • Agent							
<b>CYBERWARE</b>							
Cybereye x2 w/ Lowlight/Infrared Vision/UV and Targeting Scope							

## DRONES AND VEHICLES

### ▶ TRACE'S REMOTE CAMERA DRONE

A flying drone operated by Trace. It can travel to any location with access to the same CitiNet his Agent is linked to.

Loadout	Default Trigger	Data
<ul style="list-style-type: none"> <li>• Observation Camera</li> <li>• Holographic Projector</li> <li>• Grenade Launcher (2 Smoke Grenades)</li> </ul>	None. Controlled Directly.	6 MOVE • 15 HP Linked to Agent DV 17 Electronics/Security Tech, 5min to counter.

### ▶ CHASE SCENE VEHICLES

Vehicle	Upgrades	SDP	Seats	Speed (Combat)	Speed (Narrative)
<b>Trace's Truck</b> <i>A beat-up, open-top truck.</i>	Seating Upgrade x2	50	6	20 MOVE	100 MPH/161 KPH
<b>Gyrocopter</b> <i>A small, two-person rotorcraft used primarily for courier gigs.</i>	None	35	2	20 MOVE	100 MPH/161 KPH



## BACKGROUND (READ ALOUD)

*Regret plagues your nightmares. All those shouldas, wouldas, couldas piling on thick, flat lines, forcing you awake at 2:30 a.m. Flatline: What a conveniently shitty word for murder. You prop yourself up in bed, open your mouth to scream, but nothing comes out. You throw your blankets off, trip over your roommate's laundry, and head to the bathroom. You shake one bottle after the other, hoping to find something—cheap-ass 'Dorphs maybe—to chill the fuck out. Success! Wait. Aspirin? Crap. Welp, only one thing left to do: Find a way to burn off your guilt. Hmm ... There's that new hotspot all those suburban twits keep talkin' about. Delirium. Perfect.*

## THE REST OF THE STORY

It begins with a night out, as the Crew heads to Delirium, a virtuality club. But this is Night City, and a simple night out quickly turns into a nightmare.

After the body of a wealthy CEO's son is discovered drained of blood, security turns Delirium upside down until they find some likely suspects: a group of teenage street kids dressed as vampires. The teens naturally panic and race to the exit. But are they behind the murder? Before the Crew has a chance to find out, a ransomware attack breaks out, and the teens scramble to safety. Security's hands are full, the teens slip past Lawmen, and the Edgerunners follow close behind—narrowly escaping a riot.

With Delirium surrounded, the Crew has no choice but to follow the teens to safety underground to a place the kids call Home. The Edgerunners put their lives in the teenagers' hands, and head underground to glean vital clues about the victim: Roman Deckard, son of Cactus Water CEO Lilah Deckard. The kids confess that Roman started hanging out at the club about a month ago because he wanted to hire a hacker: someone who knew the rules, but never played by them. Putting the clues together, the Crew emerges from Home with the identity of the murderer.

The Crew's luck takes a bad turn when they realize that beat cops weren't the only antagonists pursuing them. Lilah Deckard's security team waits for the Edgerunners when they re-emerge. Outnumbered

and outgunned, the security team kidnaps the Crew and brings them to meet with their boss. After a tense conversation, harsh truths and deadly secrets rise to the surface: A mysterious antagonist called Red Knight has declared vengeance on Deckard and her family. What began as Lilah Deckard's interrogation of the Crew quickly turns into a distraught mother's plea for help.

Lilah Deckard begs the Crew to help her confront Red Knight once and for all; as part of the Crew's payment, she'll also clear the teenagers' ransomware fees—but only if they come with her. As a gesture of good faith, Lilah promises she'll confess live to clear them of any wrongdoing. Only it isn't so simple. In the end, everything goes wrong in a final encounter.

Faced with terrible choices, the Crew must decide whether to save a grieving mother or a teenage victim. Either decision will result in life-changing consequences that will leave the Edgerunners soaking **red**.

## THE SETTING

Walking into Delirium is like stepping foot into a shattered mirror—until the Crew remembers to put their virtuality headsets on. Part-fashion accessory, part-tech, the Dee Vee overlays specially designed optics and audio over reality, coded to only present enviros inside the steel-and-glass building. Once tuned in, the user chooses an enviro from that night's list of genres, then loses themselves in a musical dream. Most clubbers wear the proprietary headsets, because the first enviro of the night is always free. Importantly, once on, the Dee Vees lock to prevent the headset from popping off and getting damaged during the often-frenetic dancing. The Dee Vees can be manually unlocked by pressing a combination of buttons built into the headset.

After the Crew personalizes their avatars and picks their preferred virtual worlds, they'll feel a vibrating bass, bathe in an explosion of neon colors, or listen to a mournful singer hum. Suggested thematic effects include:

- **Horrorpunk:** Dim or flickering lighting, walls covered in blood, mud, or rust, throats slashed, zombie-green skin, corpse-white eyeballs, decomposing body parts, intermittent shrieks and moans, rattling chains

- **Dark Cabaret:** Antique lighting, bodices, fishnet stockings, velvet jackets, black-and-white striped pants, theater-style makeup, vintage photographs and paintings, orchestra instruments
- **Synthpunk:** Blackout with glow-in-the-dark hair, tattoos, and makeup, flickering neon lighting, symbols of thunderbolts, lips, stars and hearts, electric guitars, drums, and synths
- **Skatepunk:** Fluorescent lighting, T-shirt, hoodie, jeans, shaved heads, piercings, and beanies, skateboards and roller skates, street art, skulls, and graffiti, roving party lights, acoustic guitar
- **Deathpunk:** Dim or candlelit lighting, spiky black hair, silver crosses, the grim reaper, and coffins, pallid skin, heavy makeup, lace, vinyl, or satin outfits, gentle sobbing, violins, drums, guitar

When the Edgerunners aren't wearing their Dee Vees, they notice the club exudes a late 20th century-industrial vibe with all lighting and furniture riveted to the floors and walls. Black-and-yellow construction stripes line rusted pillars and brushed steel walls. Fluorescent lights hang from the tiled ceiling on chains.

On the second floor there's a small stage for live acts. The surrounding walls have long, ballet-style bars that clubbers can grip or lean on. The bar and stools at the opposite end of the space are brushed stainless steel.

The third floor is for staff and "invite-only" VIPs. It is split into three rooms: a security booth; a lounge filled with couches and soft lighting; and Magnus Haggard's apartment. The headsets do not function on this floor.

Later, the Crew visits Home, a community of transient kids gathered together for safety and companionship beneath the streets of Night City. Despite the location, the kids of Home do their best to make the place their own with glow paint and graffiti.

The mission's final location is an abandoned warehouse in Little Europe, unremarkable except for what can be found inside.

## SUSPECTS AND OPPOSITION

The heart of this story is a mystery that unfolds with each dramatic turn. Edgerunners who leap to assumptions might treat certain characters as suspects until

they understand their motivation and role in the murder and the larger narrative. Because this is a mystery, it is possible to move through the entire Mission without engaging directly in combat.

- The **Lost Kids** are the main suspects. This group of homeless teenagers dressed like vampires live beneath Night City in the sewers in a self-ruled community of orphans. Five teens are the primary suspects: Flaxx, The Impaler, Two Thee, Asher, and Dave. The Impaler is the primary combatant and defender of the group.
- **Lawmen** on patrol set up a checkpoint outside Delirium and chase the Edgerunners, treating them as suspects, once they're out on the street.
- **Private Security** hired by the victim's mother, Lilah Deckard, is initially convinced the Edgerunners are the murderers. The black-masked team members answer only to their boss, Lilah's bodyguard, **Hannah Prime**. Lilah also has a driver who does not engage in combat.
- **Red Knight** is a mysterious puppeteer pulling everyone's strings. In **Bathed in Red**, their goal is to cause chaos, harm, and misdirection to relentlessly pursue their victims (in this case, Lilah Deckard and Cactus Water) and avoid exposure. Their preferred method of attack is through hacking, ransomware attacks, and sharing deep fakes to torment and extort targets who "deserve" their wrath. After identifying Red Knight's role in the murder, the Crew hunts them down in **One Red Night** (SEE PAGE 149).
- **Lilah Deckard** is the victim's mother, CEO of a homeopathic startup called Cactus Water, and Red Knight's real target. Why? Turns out Deckard is keeping secrets of her own...

### SEE PAGE 146 FOR STAT BLOCKS

As the story develops, the Edgerunners are increasingly treated as dangerous suspects who must be brought to Lilah Deckard for questioning. To boost the difficulty of this scenario, put a private bounty on the Crew's head that activates once they leave Delirium.

The bounty is issued so quickly that only low-level thugs, corrupt Lawmen, and greedy mooks spot the Edgerunners before veterans have a chance to target them.

## ABOUT DELIRIUM

*Delirium is an alternative lifestyle club scene where every type of goth/punk fits in. It is a three-story kickass entertainment scene that ranges from cute (think Lolita fashion) to in-your-face BDSM fashion. Glitter goths, Victorian, industrial, cyber-you-name-it—this scene has something for club attendees with those interests thanks to cheap, proprietary virtuality goggles known as Dee Vees. The first enviro of the night is free, but switching virtual environments costs 20eb (Everyday). Of course, drinks cost extra, and Delirium is considered a Good Bar (SEE CP:R, PAGE 376). The signature drink is the Zombie Prom, a citrusy highball served with fake eyeballs floating inside. It costs 50eb (Costly) because the eyeballs are made with real gelatin.*

*The Dee Vee virtuality goggles only function inside Delirium and are fed data through the Control Nodes in the club's NET Architecture. Under normal circumstances, the club manager, Magnus Haggard, can download a clubber's basic data or even override experiences using the Knight's Helmet—the system's master control.*

## THE HOOK

*You're sweating out your nightmares on the dance floor, but your ghosts won't let you relax. Something about wearing a headset that hacks your sound and vision makes you squeamish, almost paranoid. Sure, Delirium is shiny and new. The second floor even smells like fresh paint and dry ice. But you can't call the club "safe." Even now, you can't tell if anyone's watching you, but you're sure someone is. You fake that "I'm-having-a-great-time!" laugh and secretly scan the crowd. That's when you notice huddled, dark shapes hanging near the far wall. You rip your headset off. Shit. They're just a bunch of scrawny kids munching on Kiwi Kibble. What horror movie did they crawl out of? Pallid skin, blood-red eyes, moon-white fangs. "Some new poser gang?" you wonder aloud. "Or is that just part of the club's schtick?" But no one listens. Not with those lights flashing and that heart-thumping bass. Lost in Delirium. Some nights start with a job. Other nights end with one. Tonight, the Crew heads to an upscale mall-turned-nightclub called Delirium, south of the Continental Brands offices in Little Europe. Delirium is the kind of "everything goes" club that isn't supposed to exist unless you know the password. That doesn't stop all those students from the University District barreling through or those rich kid posers from the Executive Zone stinking up the place with their overpriced aftershave and Bag Lady Chic rags.*

By the time the Crew arrives, there's a line out the door, and only VIPs can skip the wait. To speed things up, the Crew can use an appropriate Social Skill to bribe, cajole, hack, or con their way to the front. Once inside, the Crew picks a headset, and is free to explore the three-story club.

A Perception Skill Check against a DV 13 allows Edgerunners to scan their mind-bending landscape and see the

differences between reality and virtuality. The Crew can search for clues by noting what isn't in their experience. Staff and security are presented as characters in the themes. Anyone not connected or designed in the programs are displayed as a dark, humanoid shape by design—as a means of encouraging clubbers to wear the headsets and pay for upgrades.

Unfortunately, the Crew's R&R doesn't last long.

Once inside, the story begins in one of two ways: Either an Edgerunner removes their Dee Vee, or they investigate their surroundings while wearing it.

The virtuality environments provide clues by omission. Besides the occasional dancer, there is a cluster of shadows whispering at the back of the club on the second floor. If any Crew member takes off their headgear, they'll notice a group of ratty-looking teenagers huddled in the corner. There are a handful of naturalists in the club as well, too granola to blend in, drinking high-end Euro cocktails out of sugar-rimmed whiskey glasses.

When one or more Edgerunners removes their Dee Vee headsets, a crochet mini-dress-wearing naturalist with powder pink hair—too doll-like to be cool—chats them up. It's clear from her appearance she's one of those who shuns technology, but there's something off about her that smells like eurobucks.

Anya isn't wearing a headset, has no cyberware installed, and isn't using any tech—not even a phone. Her only accessory is a refillable glass bottle and a macramé wristlet. Thieves discover the purse is stuffed with 1,000eb in hard currency, several Biotechnica consultant business cards, and a tube of organic lipstick.

*"So, you don't like wearing those headsets either? I would, but all this tech—ew, it's so toxic to the body. Unnatural, y'know? I just wanted to dance. Not with you, I mean.*

BY DOMHNALL HEGARTY



Delirium First Floor



Delirium Second Floor

*I came here with my friend Roman, but I lost him in the crowd. I... I'm worried about him. Will you help me find him? There's no reward or anything. I mean, you look kind of desperate. Hey, my name's Anya, what's yours?"*

Agreeing to help Anya leads the Crew to the crowded second floor, where they discover Roman's body propped up against the wall. The lifeless body does show up as a humanoid shadow in VR but doesn't seem suspicious because the corpse has been carefully posed to chill.

If the Crew brushes the snobbish socialite off, she follows them until they're on the second floor.

*"Hey, I need help. My name's Anya, and I—"*

Anya stops mid-sentence, points to a body lying face down on the second floor, and screams.

*"He's dead? Oh my God, I told Roman we shouldn't party in the slums with those vampire wannabes! Security! Security!"*

Anya wags a finger at the teenagers, then ditches the Edgerunners to run up to the third floor. The Crew has one Round to investigate an obviously posed body dressed in Bag Lady Chic before dancers start to panic and security shows up. Each Edgerunner can take one Action to glean a valuable clue.

- The body has no cyberware installed.
- The victim has been stripped of all valuables. The tattered trench coat reeks of whiskey.
- Twin puncture wounds are found on the victim's neck.
- The body has been drained of blood and is still warm.
- Evidence overwhelmingly indicates a vampire as the murderer; there's no clear way to tell how long the body has been dead. However, it's clear the body was moved from the scene of the murder.

Scanning the room, the Edgerunners notice the Lost Kids, dressed in dusty, goth outfits and clustered by the wall. The kids seem nervous. They constantly look over

## WHAT'S CACTUS WATER?

Cactus Water is trendy bottled water, said to be drawn from succulents and purified via a crystal-driven, homeopathic process to fortify it with life-affirming, health-improving minerals. It is also the name of the company, supposedly independent and founded by Michael Deckard (though now run by his wife Lilah). Cactus Water sells for 10eb (Cheap) a bottle.

## THINK FAST

Edgerunners who support Anya or maintain crowd control could lose sight of the Lost Kids and miss important clues. Assisting the bouncers because making sure people don't get hurt is "the right thing to do" impresses the club's manager, Magnus Haggard, who gives them access in exchange for their help solving the murder to clear the club from any wrongdoing. In this case, Asher should remain captured instead of released in order to provide the Crew with a link to Home and the Lost Kids.

their shoulders. They're also teenagers. As soon as they spot the Edgerunners, the teens don't run, but they stare. A Perception Skill Check reveals they're huddling closer together to hide their convenient exit—a staff-only stairwell connecting the other two floors.

Seconds later, alerts begin popping up on Agents: *Teen Streetrats Flatline Heir to Cactus Water Empire at Delirium. Suspects Still at Large. Reward Offered.* Report to Police. The crowd is slow to react. Some clubbers keep dancing because they assume the alert is part of their enviro, while others pause to listen. Few remove their headset, giving the Crew an opportunity to act first and think fast.

The Crew has moments to catch the street rats, but the Edgerunners must maneuver through a cluster of panicked dancers and the bouncers trying to corral them.

## GO TO DEV (RANSOMWARE)

## DEV (RANSOMWARE)

The Lost Kids quietly slip down to the first floor while Delirium's muscle controls the crowd and safeguards the body. If the Crew tries to intervene, the bouncers (use **Bodyguard, PAGE 172**) point them to the nearest exit: They've already called the law and news reports on the Edgerunners' Agents confirm this.

Some clubbers are slow to understand what's happening; dancers in the horror-punk and deathpunk environs assume the chaos is "part of the experience" until told otherwise.

Edgerunners not wearing headgear experience the following.

*You've never seen so much muscle standing in one place before: a wall of bouncers protects the victim's body. Suddenly, one clubber dressed in an iridescent bodysuit rips off their helmet and lunges for a*

*white-haired street kid, tackling them to the ground. Someone screams: "Asher! Meet us at Home! We'll wait for you!" Soon as Asher's pinned, a pierced steel-and-leather goon lifts the first attacker by the shoulder and tosses them aside. Only, there's an even bigger punk standing right behind him.*

Club patrons and Edgerunners wearing Dee Vees suffer from a ransomware attack. The controls for the locking mechanism on the Dee Vee shut off, making it impossible to remove the headset. A sharp, piercing sound whistles in their ears, followed by a gruff voice-modulated recording.

*"You are a sinner. Your ancestors were taught breathing clean air, drinking fresh water, eating fresh food—it wasn't enough. It was never enough. Sure, you've got sins of your own. Doesn't matter. All that fucking and killing and running and fucking some more. Do you ever save anybody? Well, here's your directive: Save yourself. Do penance. Send 10,000eb to Red Knight's listed account, take off your headgear, and leave."*

When the message ends, the Dee Vees begin feeding their users a blinding blast of psychedelic light and sound. Anyone wearing a Dee Vee suffers a -4 modifier to all Checks.

Panicked clubbers and armed bouncers now stand between the Crew and the accused Lost Kids heading to the exit. If the Edgerunners try to muscle their way down to the first floor, they'll need to succeed at a DV 13 Athletics or Evasion Check to succeed. If the Crew is seeking an edge, using the right Skill reveals the bouncers are using unencrypted Radio Communicators to coordinate their movements; this tech can be hacked, making it possible to get through the cordon without an Athletics or Evasion Check. In addition, a DV 15 Perception Skill Check highlights a loose grate the Edgerunners can remove to drop down between floors.

Jumping through the grate allows the Edgerunners to beat the kids downstairs and avoid the panicked crowd. If the Edgerunners make it to the first floor **GO TO CLIFF (THE LAW ARRIVES)**.

While on the second floor, the Crew has options. They can:

- **Rescue:** Rescuing the kid and ensuring Asher won't be harmed or ransomed grants them an automatic escape from the club—Asher befriended one of the bartenders and refers to her as “Mom.” This can be accomplished using raw muscle, Social Skills, or any other plan the Edgerunners come up with. In future encounters with the Lost Kids, Social Skill DVs are reduced by two.
- **Pursuit:** The Crew can either move the grate or maneuver through the crowd to use the stairs and get downstairs before the teenagers do.
- **Helping Out:** Choosing to help the clubbers impresses Magnus Haggard and grants the Edgerunners a no-questions-asked favor if they can find Roman's murderer. Data Pool searches related to the mysterious hack come up empty. Whoever installed the ransomware is an elite Netrunner.

When the Crew reaches the first floor, they are free to take one Action without hindrance. Four of the Lost Kids are holding hands, forming a tight line, weaving through the crowd. Flaxx recognizes the Crew and confronts them, asking where Asher is. Any Social Skill DVs in this encounter are increased if the Edgerunners left Asher behind upstairs.

The tense scene doesn't allow for a long conversation, but the Crew can ask the teens one or two questions. The Lost Kids are tight-lipped and are reluctant to trust. They constantly look over their shoulders as if expecting someone to jump them. It's clear, however, that the teens are anxious because they know something. The Impaler

and Dave tell the others to keep quiet; Two Thee points to the headsets and then their eyes. Though not as many clubbers are wearing their Dee Vees, the message is clear: Someone might be recording that night's activities.

To ally with the Lost Kids, the Crew can offer protection until they can talk somewhere safe. As soon as the Edgerunners have befriended the teens, **GO TO CLIFF (THE LAW ARRIVES)**.

## CLIFF (THE LAW ARRIVES)

The Edgerunners and Lost Kids are on the first floor when someone hears a loud, popping noise.

*Pop. Pissssshhhhhhhh. Pop, pop, crash! Weeee-ooooo, weeeee-oooo. The kind of riotous noises that make your heart race, your eyes twitch, your muscles lock up. You instinctively pull the nearest person toward you, drop into a crouch, and put your hands over your ears. You hear yourself yell: “Duck!” Your mind barely registers the inevitable moment the front windows explode in a shower of orange-yellow sparks and razor-sharp shards. Your gut tells you to hang tight, to secure your Crew, but your mind tells you to run: Lawmen have arrived. Night's over—and maybe also your chance to figure out what the hell is going on.*

The Crew must successfully dodge the sharp debris flying into the club (Evasion Skill Check DV 13; treat anyone who fails as if they had been hit by a Very Heavy Pistol). Before the Crew can lick their wounds and check on the teens' safety, frightened clubbers start throwing punches and rush toward the exit—where the cops are waiting. Unfortunately for the Edgerunners, Lawmen (Use **Security Operative, PAGE 173**) bar the door from the street, preventing anyone from leaving. A disgruntled veteran barks through the door, but few clubbers are listening.

## ADDICT IN HIDING

*Staff worries Haggard is addicted to Smash, and the club will shutter if he doesn't get help. Proof? The sound of sirens sends Magnus Haggard into a panic—the manager is incapable of dealing with the crisis at hand—forcing him to hide in his apartment upstairs.*

## WHO'S ANYA AGAIN?

*If the Edgerunners ask Magnus about Anya they quickly learn that she never approached him, or any staff member. Interviewing other club goers yields different results. They noticed the woman following Roman, but note that it didn't look like the two knew each other.*

## ASHEN FACE

*If left on the second floor, Asher asks for help from a bartender named Zero Gees (“Mom”). Instead of letting the teen go, Zero Gees marches Asher up to Magnus Haggard's apartment for questioning, only to find Magnus Smashed out and comatose. If the Crew has lost the Lost Kids, keep Asher at Delirium so they have a link to Home. Otherwise, Asher will use the moment to escape.*

## MAKING IT WORSE

A sure way make the panic worse is to pull out guns and start shooting. That transforms things from a panic to a full-out riot. Should this happen, each Round spent in the club requires a DV 13 Athletics or Evasion Check to avoid taking 4d6 damage from being trampled. The Lost Kids still get out unharmed but be understandably wary of any adults who shoot in a tense situation.

## DEE VEE RANSOM

Removing a locked Dee Vee requires either a DV 15 Electronics/Security Tech Check or a DV 17 Pick Lock Check. Anyone who pays the ransomware fee receives a code they can input into the Dee Vee to unlock the helmet. Leaving the club stops the psychedelic effect, but the headset remains locked.

Red Knight accomplished this act of ransomware trickery by leaving a Virus on the bottom level of Delirium's NET Architecture (SEE PAGE 145). A Netrunner looking to shut down the scheme must make their way to the bottom level and use the Virus Action (DV 12; 10 NET Actions) to counter Red Knight's sabotage.

*"Form a line, assholes. You want out of this club? Good news. Gotta free ride down to the precinct. That's right. You're all getting arrested for disorderly conduct. That window you shattered? What? You think popping off your mighty pistol makes you a baaaaaaaaaaaaaad mook? You don't know shit. That sweet kid's murderer locked in the club with you? Them's the bad guy."*

An appropriate Skill Check reveals the beat cop is lying: The Lawmen smashed the window to justify breaking into the club. The beat cops' presence and the now-broken window triggers a full-blown riot. The Crew is caught between a murderous crowd, a lethal obstacle, and the kids they're now trying to protect.

What's more, a new official alert is issued from Night City PD claiming the Crew are the murderers: *New Suspects in Roman Deckard's Murder Found in Delirium. Armed and Dangerous.*

With the exit blocked from the outside, the Crew must think quickly. The stakes are high, and the only way to clear their names is to find out what the teenagers know. If the Edgerunners do not want to turn themselves in or be captured, they can:

- **Use Brute Force:** The club's entrance stands between the Crew, answers, and their freedom. Using brute force to open or break down the door causes the masses inside Delirium to pour out onto the street—which temporarily scrambles the Lawmen until they can get the crowd under control. This is a distraction the Crew and the teens can use to ditch the cops in a nearby alleyway.
- **Leaping Out:** The Edgerunners and suspects can leap out the shattered front window with an appropriate Skill and run for cover behind the club. Witnesses report and share videos of their escape with Lawmen. The cops

assume the false alerts are accurate and are convinced the Crew is involved in Roman's murder.

- **Follow the Lost Kids:** Asking the teens for help results in their bartender friend leading the Crew to a hidden entrance they use to come and go from the club through the bar. This forces the Edgerunners to sneak past two bouncers and a bartender. If they're unsuccessful, the staff doesn't engage in combat; they herd them back toward the front. The Crew is free to try using Stealth or take a different Action. If Asher is not with the group, increase the DV. Two Thee will take point in Asher's absence, and utilize a more technical, rather than social, approach to slip outside.

To avoid an encounter with police, the Crew must escape the club before local authorities break into Delirium and arrest both the teens and them. When they're back on the street, **GO TO DEV (GOING HOME)**.

If the Crew and the Lost Kids are caught or the Crew turns themselves in, The Impaler sprints away, evading the Lawmen. **GO TO DEV (CAUGHT BY THE COPS)**.

## DEV (CAUGHT BY THE COPS)

Before the police will listen to the Crew's professed claims of innocence, the beat cops try a bit of extortion, making it clear they're more interested in money than solving a murder.

*"Well, listen up assholes. I ain't in the kind of mood to repeat myself, if you know what I'm saying. These kids might be broke, but I'm guessing you're not. You want to cooperate with the police? Make your lives easier? You gotta buy me some coffee and a pastry. The 500eb kind. For, erm, me and my friends over here. Each. You like Eddie, right? Thought so."*

BY TORBEN WEIT



If a member of the Crew is an NCPD Lawman and flashes a badge, the cops let them go but insist on holding onto the rest of the Edgerunners “for safe keeping.”

Continuing the conversation and making a successful Social Check or paying the Lawmen’s bribe helps the Edgerunners understand why the cops are acting more corrupt than usual: Lilah Deckard is paying a sizable sum to the police to let her handle Roman’s case, provided they hand over all suspects to her for questioning before booking. Once the Crew learns this crucial piece of information, they have three options.

- **Con the Cops:** The Crew can fool the Lawmen by claiming they’ll recapture The Impaler, but only if they can bring their new friends along. Otherwise, the teens suspect something’s wrong and won’t come with them. Successfully convincing the cops of their plan frees both the Crew and the teens.
- **Agree to Meet Lilah Deckard:** The Crew can persuade the beat cops they’re willing to meet Lilah Deckard without any strong-arming. The cops play

with the Crew first, trying to work a bribe out of them to avoid being booked or hauled downtown. Successfully convincing Lawmen to drop the act frees the Edgerunners but not the teens. During the negotiation, Two Thee manages to slip away. If the Crew follows this path, **GO TO CLIFF (A MOTHER’S WRATH)**.

- **Dump the Police:** The Crew can turn their backs on the cops and make a break for it. The kids scatter, but their destination is clear: They’re heading to an alleyway behind Delirium.

Assuming they don’t go to meet Lilah Deckard right away, when the Edgerunners and one or more teens have ditched the cops, **GO TO DEV (GOING HOME)**.

## DEV (GOING HOME)

Exhausted from running, the Crew helps the teens remove a sewer grate in the alleyway next to Delirium, dropping underground with Flaxx while Dave runs off. Teens who

## HOME AS A NIGHT MARKET

The kids of Home have made friends with a few different Fixers in Night City. On occasion, they pile up all their salvaged goods and bring it to one of the Fixers who helps the kids set up a Night Market. While the Fixers do the setup and take their cut, the Night Market itself is run by the kids, who do all the haggling and selling. Home's Night Market is never in the actual place where the kids bed down—that's just inviting trouble.

## RULES OF HOME

1. Whatever is brought from the surface belongs to the scavenger, and they decide what to do with the stuff. Thieves are asked to leave.
2. No Street Drugs. If found, they get dumped.
3. No violence except in defense. No bullies. Period.
4. No one who doesn't want to talk will be forced to unless it's a secret that puts another kid's life in danger.
5. Adults (anyone older than 18) keep everyone safe as best they can, but they can't stay Home once they turn 21. If an adult hurts a kid, they must leave.

were either left behind or escaped (Asher, Two Thee, or The Impaler) wave at the Crew just up ahead.

Before the Crew reacts, The Impaler leads the Edgerunners down a short tunnel and into a meter-tall pipe. Scurrying through the pipe, the Edgerunners hear noises on the other side. When they emerge out into a large area stuffed full of makeshift furniture and kids, The Impaler drones.

*"Welcome Home. Ain't much, but a sturdy roof's all we got. Don't shoot anything down here, 'kay? Gonna kick you out if you do. Lot of these kids have a story to tell. It's not the kind they want to, either. The ones that don't wind up addicted, dead, or worse. Those who wanna live come here and work with us. Survive with us. Safer in numbers, right? 'Cept there's always more coming. Always more dying. So don't fuck anything up and just chill."*

An appropriate Skill Check reveals what Home is: a transient community run by street rats that doubles as an occasional Night Market run with the help of a few friendly Fixers. The location isn't important: Home moves when needed.

When the Edgerunners figure this out, The Impaler pulls out a flashlight and continue.

*"Everyone assumes we're vultures picking bones, don't they? So scary. Only, we scavenge 'cause we have to. Every cold body hittin' the street is a gift for Home. We strip the corpse and take whatever eurobucks they had. Finder's fee. The rest of their shit? We use, resell, barter, trade. Sometimes for information or eurobucks; sometimes for a hot meal or a warm bed or a doctor. Food, drugs, medicine, weapons, armor—we sell nothing out of the ordinary. Just enough to survive, 'cause that's all that's left for us. We're not monsters. We've just been forgotten."*

When the Crew emerges from the pipe, they find themselves lost in a maze of causeways and tunnels decorated with strange, glowing symbols. An appropriate Skill

Check reveals someone used neon glow paint to brush odd symbols on the sewer walls—a secret messaging system only the kids understand to navigate the labyrinth.

Like any home, the teens have House Rules the Crew may not understand but are expected to honor.

Despite its friendly name and cobbled rules, Home is anything but. It's dingy, damp, and dark. Many of the kids suffer from malnutrition. A First Aid or Paramedic Skill Check uncovers more bad news: Many of the kids have health problems—the kind that only a Medtech with a good budget could fix. The community of homeless kids is also much bigger than the Edgerunners could've guessed. There are about 60 teens of different ages, mostly thirteen to seventeen, with a handful of kids under 10. To survive, they pickpocket and strip the dead, but only take what they can use or sell.

Many of the teens hate the sight of blood and are uncomfortable around dead bodies and avoid street drugs—some have even lost a sibling or a parent to addiction—but understand the value of medicine. A quick scan of the area proves it isn't secure, but it does seem strategically placed. The kids could retreat into the sewers if someone did attack, but they'd leave everything behind.

The Impaler asks the Crew what they think. Edgerunners who are disdainful—or who assume one good sweep by Lawmen will "fix" the homeless problem—encounter tight lips, a quick tour, and an escort to the nearest exit. The second the Crew threatens the sanctity of Home, the kids surround them, forcing them to leave.

Scanning the area, an appropriate Skill Check uncovers teenage sentries at the entry and exit points. The teens don't use tech and there aren't any cameras or drones in the area. If someone wanted to invade Home, it'd be easy to do it—which explains why the kids are so hesitant to trust the Edgerunners.

Edgerunners sympathetic to the kids' plight are asked for help in exchange for information. The Impaler faces the Crew with a hard look, saying:

*"I don't trust you and I'm not sorry about that. Yeah, you helped us before, but if you want deets, you gotta know—anything we tell you is a risk. Anything. And I got a lot of mouths to feed. So, if you want to help? Help. If you don't, no harm done. Just leave."*

If the Crew wants to leave, they can do so without gleaning any more clues. By the time they reach the street, the kids will have already started to pack up and move. If the Crew has already met with Lilah, **GO TO CLIMAX (A KNIGHT'S EXCHANGE)** otherwise, **GO TO CLIFF (A MOTHER'S WRATH)**.

If the Edgerunners want to help, they can do chores. Tasks give the teens an opportunity to assess the Crew's motives, while ensuring "their" people are protected. Somebody's gotta do the work, after all. Getting info out of them will require either solid bonding or a successful Social Skill Check made against the kids.

Each Edgerunner is free to choose a task best suited to their interest and Skills. Each of the Lost Kids is skittish and slow to trust adults.

## FIND HEAT WITH FLAXX

Flaxx is chattier than usual because they appreciate the help. The job is to find, build, or turn on sources of safe heat to warm their part of the underground without suffocating themselves. They tried heating Home with fire but couldn't control the smoke. While the Edgerunners scavenge for parts and gear, Flaxx blurts out they never want to turn 21.

When a kid ages out, they're forced to leave Home for their safety, but she suspects the graduates don't live long. Sure adults have a way of messing everything up, but Flaxx is worried The Impaler won't live to see 22. None of the kids want to go into the system or back on the streets, because they've tried all that already. What choice do they have?

Flaxx shyly confesses they know what happened to Roman because they helped move the body. The kids made a pact not to tell anyone unless Dave said so but they're feeling guilty and feel the need to share the burden.

Edgerunners who complete one or more tasks quickly learn the teenagers don't want to cause trouble and understand that no matter what the truth is—someone is always looking to blame or use the kids.



BY DIEGO MARTINEZ

## SORT WEAPONS WITH ASHER

Piles of discarded pistols, swords, chainsaws, and purse-sized locked gun cases need to be sorted, checked, and disarmed if necessary. This chore is frustrating for anyone who doesn't know their weapons.

Halfway through the task, Asher asks the Crew how old they are, what their lives are like, if they ever had a dream. They tell the Edgerunners they're 14, just started dating, and dream of turning 21.

## ADMINISTER FIRST AID WITH DAVE

Dave wordlessly pulls out a rusty first aid kit and a crate of hygiene products and cheap pharmaceuticals. Fifteen kids, aged 10 to 17, form a line and wait for help. Dave won't talk at first—not unless the Crew forces him to—but he expects the Edgerunners to help.

A slow approach can frustrate the Edgerunners; an appropriate Skill Check uncovers more details. Dave is suffering from depression and PTSD; his symptoms are consistent with witnesses of extreme violence. Helping

## MEGABITE

Megabite is the first in a new line of cyberware packages from Rocklin Augmentics called RockXotics. Designed to compete with Biotechnica's Bioexotics line, RockXotics makes use of a combination of fashionware and other cybernetics to bring people an Exotic experience without the need for Biosculpting. Megabite combines Vampyres, a temperature regulation-based Chemskin, and Shift Tacts to create a vampire-like appearance. With the help of a hired Ripperdoc, Red Knight installed a modified version of the Megabite package in the Lost Kids to allow for remote control, the rapid draining of blood via an oral suction system, and dangerously extreme dermal temperature shifts, even to lethal levels.

The kids don't have the knowledge or eb to get rid of Megabite but one of the Crew might be a Medtech or know one who owes them a favor. Removing Megabite without damaging the patient requires a DV 15 Surgery Check and takes four hours. The cyberware can also be "reset" with a DV 17 Cybertech Check while still in the body. This gives the user one hour of freedom before Red Knight takes control again.

the sick and injured gives Dave something meaningful to do. Patient Edgerunners skilled in healing will earn Dave's confession once the line winds down.

*"I bullied this girl at school. Her name was Shondra something. We both studied Biz Dev at Night City University. One day, she got sick. Started losing her hair. Thought it was hilarious, right? Like a fucking horror movie. She looked like shit. Sores. Cracks in her lips. Bags under her eyes. Twitching leg. Said she wasn't contagious. Side effect. Vitamin deficiencies. Only, she couldn't wait to get healthy. Had to graduate that semester or lose her fancy new job. I just couldn't stand the sight of her. So distracting! Then, I tormented the ever-living shit out of her. She... committed suicide. I got depressed. Flunked out. I ended up down here. It seemed like somewhere I could make amends. And for a while, I think I did.*

*"Then Red Knight found me. Dosed me. Wired me up like a puppet. Yeah, I killed Roman—because the Knight forced me to. Should I go to prison? Do I deserve to? I did commit murder... maybe more than once. Shondra..."*

Dave explains he didn't kill Roman inside Delirium; he murdered him earlier that day, then asked the other kids for help to move and pose the body. He's also wearing the murder weapon: a surgically-installed vampire package called Megabite.

Red Knight caught Dave when he was out scavving, knocked him out, and installed the Megabite. When Dave woke up, Red Knight was gone but there was a message: the installed Megabite was fully under Red Knight's control. Red Knight could remotely operate his fangs, his contacts, and even affect the temperature of his blood. Unfortunately, Dave couldn't pay the Eurobucks Red Knight wanted to remove the ransomware and the price kept climbing. Then, somehow, Red Knight found out what Dave did to Shondra and weaponized Megabite, messing with the street kid by activating and deactivating the

fangs and raising his internal body temperature to dangerous levels, resulting in extreme fevers, chills, vomiting, and dehydration. After hours of this torture, Dave finally caved to Red Knight's demands and attacked Roman in a nearby alley a couple of hours before they went to the club. Then, he punctured Roman's jugular. Red Knight said all Megabite would take was a quart or two. No big deal, right? Just a prank. Dave chugged more beer than that on a Saturday night, didn't he? But Red Knight lied and Roman's blood—all five quarts of it—was sucked out faster than Dave could swallow, forcing him to puke it all over the alleyway, bathing them both in red

Dave wasn't the only one who got isolated, cornered, and upgraded with Megabite. All the Lost Kids who were at Delirium suffered through the same thing, though only Dave was directly extorted into murder. The rest just need to pay the ransomware price to get control of their involuntarily implanted cyberware.

After Roman's blood was drained, the other kids found him. They'd seen dead bodies before, but not like this. They didn't ask questions, just helped. Cleaned everything up and brought extra clothes. That's when Dave got new instructions: Bring the body to Delirium and make sure it's on the second floor. Why Delirium? Dave guessed Red Knight found out something about the club's manager, Magnuss Haggard. It's always personal. After that, Red Knight said they weren't done with him yet. And the price on his head just kept going up. The price of his freedom? 50,000eb. The others are luckier. So far, they only owe 10,000eb each.

Unfortunately, the teens do not have control of Megabite and they can't afford to hire a Ripperdoc to remove it. This fashionware has impacted their appearance. The teens' eyes are red, their skin is pallid and cold to the touch, and their porcelain fangs are held hostage by Red Knight's ransomware. Dave assumes Red Knight will never leave the kids alone because they're useful. They're also witnesses.

## SPY ON COPS WITH TWO THEE

Heading up to the surface to see what the Lawmen are doing is Two Thee's idea. The Crew is directed to a construction worker's ladder they can climb up.

When whispering, the teen addresses the Crew as "doombas," slang for "sketchy stranger."

*"Hey doombas, yo, that Roman was sniffin' for a Netrunner. Someone who could do some real shit, yeah. Stuck extorted like we are. 'Cept he wasn't wearin' no Megabite. Kept saying the vid of his dead sis got deleted or some shit. Yo, doombas, I am tellin' you. That Red Knight is bad mojo. Got us all by the short hairs."*

Emerging onto the streets reveals that Lawmen are still active in the area. Spying on them audially gifts the Crew with useful chatter: The police have determined exsanguination was the cause of death and determined Roman wasn't murdered in the club. Strangely, the Lawmen are leaving the scene and heading back to the precinct. One of them mentions *"This is all that Cactus Water lady's problem now."*

## SET TRAPS WITH THE IMPALER

The Impaler blinks—his eye color shifts from red to brown and back again—but says it's nothing. The kid points an entrance north of where they're standing and asks the Crew how they'd secure the area. Social Edgerunners notice The Impaler's observant stance and realize the kid wants to hone his combat prowess. After a while, The Impaler confesses that he'll be turning 21 in a few weeks, and his friends are doing everything they can to send him off in style.

## BONUS: GOSSIP AT HOME

While hanging out in Home, the Crew can also pick up a few rumors from the Lost Kids and other residents. GMs should feel free to seed the rumors with sidequest ideas, lay future plot hooks, or just use the chatter to do a little world building and make Night City seem more alive. Here's a few possibilities.

- Last week, one of the Lost Kids turned 21 and left, so Home moved to a new spot for security reasons. It used to be directly beneath Jesse James' Kosher Deli and a lot of the kids hate this new location. Folks just aren't as generous in this part of Night City.



BY NEIL BRANQUINHO

The Impaler

- Broke and out of food, some of the adults found a crappy job testing beta fashionware. Except at 100eb per kid, it wasn't worth the trouble. Not enough food to go around.
- This part of town is more dangerous, because some Lawmen are starting to suspect street rats are stripping bodies. Most of the kids want to move soon. But where?
- The kids need food and medicine more than weapons, but their inventory is full of stuff that hurts people. The younger kids are cleaning unloaded pistols to resell for a meal.
- Most of the older kids can't afford to have cyberware installed and wonder how Two Thee got so "rich." They'd be shocked to know Two Thee was a young entrepreneur who interned with Orbital Air before their parents died.

Once the Crew has helped perform one or more chores they can leave. When they do, they'll hear the kids packing up Home behind them. If the Crew has already met with Lilah, **GO TO CLIMAX (A KNIGHT'S EXCHANGE)** otherwise, **GO TO CLIFF (A MOTHER'S WRATH)**.

## CLIFF (A MOTHER'S WRATH)

The Crew returns to Night City's streets just before dawn.

*Neon lights flicker and die. The cloudless sky overhead shifts color from vibrant purple to deep pinks and blood red. The streets are empty, but still alive. An automated street sweeper brushes broken bottles and spent syringes to the gutter. The air smells like used cigarettes, stale drinks, fresh coffee, and warm doughnuts. The shrill sound of an ambulance rushing to the ER a few blocks away echoes in the quiet morn. It's almost as familiar as that first ray of sunlight reflecting off the glassy towers, piercing your mind with the truth. Forcing you to remember you're still a suspect. That's when it comes. That slow realization—as sluggish as the sun rising—the ear-splitting toll of three fateful words: You're not alone.*

The Crew has resurfaced with information needed to clear their names and a murky path to follow. Though they know who killed Roman, Dave was also a victim. Red Knight is the real murderer, but for every clue they

discover, more important questions remain. Who is Red Knight? Why did they want Roman Deckard dead? And why does his mother, Lilah, have so much power over the police? Or, even more worrying: Why doesn't Lilah use the Lawmen and her security force to hunt down Red Knight?

Before the Crew can find answers, they are approached by Lilah Deckard's private security force. They come in force, armed and dangerous, but don't attack unless attacked. Glossy, armored SUVs suddenly pull up like obsidian rhinos, disgorging a squad of rented bulletheads. Their guns stay in their holsters, sending a clear message: We'd prefer you alive for now. A very well-heeled woman dismounts from the second SUV.

*"I'd like to buy an hour of your time." Lilah Deckard says as she steps out from behind her security, "250eb each to take a ride with me. Hear me out. If you don't like what I have to say, I'll drop you off. No harm done. What do you say?"*

Deckard nods and her security team flies into motion and escorts the Edgerunners to a waiting van. They never lower their weapons and are ready for trouble to start. After loading them into a vehicle, Deckard slips in as well.

## GO TO DEV (LILAH'S PLEA)

## DEV (LILAH'S PLEA)

Lilah Deckard and her mooks drive the Crew around town. The security detail keeps their weapons trained and ready in case things go south.

Once they're moving, Lilah apologizes for putting on a show, then asks for their help.

*"I bribed the Lawmen to look for my son. They wouldn't even bother, otherwise. When they reported finding his body, I headed right over and I knew, in an instant. This was the work of Red Knight.*

*"This isn't the first time that bastard has targeted my family. He's got it out for us. Have you heard of Cactus Water? The all natural, crystal-purified super liquid? See, my husband came up with the idea. Health water backed in secret by Petrochem. When he vanished, Petrochem insisted I take over as CEO. Then I found out the truth. Cactus Water came out of a tap. We didn't even filter it. Some people got sick. Some people died. I hated it, but I was stuck. I couldn't defy Petrochem. Couldn't run*



Lilah Deckard

BY DANI HARTTEL

away like my husband did. And somehow, Red Knight found out and decided my family had to pay for the company's crimes. First, they tortured my daughter Layla's boyfriend until he leaped off the deep end and killed himself and her. All because she was the spokesperson for Cactus Water. Next, it was my son, Roman. Now it'll be me. I've bribed my share of cops but as investigators they're useless and my private security hasn't been able to track down Red Knight. I know you and those kids are on the hook for this crime but I know you didn't do it. Please, help me."

Lilah promises to use her influence to clear the Crew's names in the murder of her son, Roman, a process she'll begin as soon as they agree to help. If the Crew mentions the Lost Kids and Megabite, she also promises to pay for the removal of Megabite. If pressed, she agrees to pay the Edgerunners 1,000eb each when the job's done.

Should the Crew turn down the offer, Lilah says she'll contact them again in a few hours. By then, the Crew will have had a taste of being wanted murders with a bounty on their heads and might be more willing to negotiate.

If the Crew accepts the offer and met with Lilah right after dealing with the cops, she suggests they track down the kids the Lawmen are after in order to get more information. Her contact among the Lawmen knows they live in a place called Home and suggests a possible entrance. Lilah ordered the kids released so they should all be there. **GO TO DEV (GOING HOME)** and adjust appropriately. Keep in mind, the Edgerunners might have to earn their trust after abandoning them to meet with Ms. Decker. Lilah promises to contact the Crew as soon as the bounty has been lifted or if she receives more information. She asks that they contact her if they discover anything new.

If the Crew accepts the offer and has already been to Home, Lilah drops them off at Delirium and suggest investigating there for clues (this is a good chance to relay information from the various sidebars from

the Delirium portion of the Mission). Lilah promises to contact the Crew as soon as the bounty has been lifted or if she receives more information. She asks they contact her if they discover anything new.

## GO TO CLIMAX (KNIGHT EXCHANGE)

### CLIMAX (KNIGHT EXCHANGE)

Close to midnight, the Crew receives a call from Lilah Deckard, asking them to meet her outside a warehouse near the docks in Little Europe. Red Knight has contacted her and wants a meeting to settle the score. The murderer stipulated she couldn't bring cops or her security or they'd bolt—but Lilah's hoping Red Knight doesn't know she's hired the Crew to work for her.

The Crew arrives at an abandoned shipping company near the docks at midnight. A luxury car with a Cactus Water parking permit on the windshield is parked on the street but there's no sign of Lilah.

That's when the other shoe drops. Two Three messages the Crew, letting them know one of the Lost Kids is missing.

By default, the missing Lost Kid is Dave. If the Edgerunners arranged to strip Dave of Megabite, then one of the other Lost Kids, who still has Megabite installed, is missing instead. If all five Lost Kids had the malicious cyberware removed, Dave is missing and Two Three notes he's been gone "for hours," but they only just noticed because they've spent the entire day moving Home to a new location.

Circling the building reveals no guards and no traps. It has been abandoned for years and there's graffiti everywhere. A single heel, Lilah's, lies near the main entrance.

Inside the abandoned warehouse, the building has been stripped bare—even the automated conveyor belts, overhead lighting, and robotic assistants have been dismantled, sold, or stolen. Free from

## CORPORATE DOOMBAS

Roman Deckard's murder has forced media types and conspiracy theorists to take a closer look at his mother's company, Cactus Water. News reports are flying fast and furious on the Screamsheets and the secret's out. The company's product? Plain tap water that hasn't even been filtered. Worse: Red Knight shared evidence that Cactus Water is a secret subsidiary of Petrochem. This is the kind of thing that can bring flashy holistic image corps like Cactus Water down in days.

## I'M TRYIN' CHOOMBA

Before the Climax, Two Three private messages the Crew. They surfed the Data Pool and pulled in some favors to ask the manufacturer, Rocklin Augmentics, for help. After giving them a few serial numbers, a Rocklin customer service rep told them the company couldn't help but did let something strange slip: Those Megabite packages were stolen on-site several months ago.



BY BORJA ALONSO

debris, the location presents another obstacle: CitiNet access is, for some unknown reason, disrupted inside the factory walls, meaning no one can call in or out or access the Data Pool. For the moment.

With no obvious structures present in the rectangular room and one poorly lit entrance, the Crew's view is clear.

*As you step into the building, your Agent beeps with two alerts. Two messages, each linking you to a different obituary. One for "Lilah Deckard." One for "Dave." Both are dead? Is this a trap? You scan the room but don't see anything—not until you step foot inside the warehouse. As soon as you do, a road flare ignites, starting a chain reaction, burning a red knight's helmet into the floor. Then... screaming.*

The cement floor is covered with burning road flares depicting Red Knight's logo. At the back of the warehouse, hiding in the corner, are two huddled figures: Dave and Lilah Deckard.

The homeless teen has his fangs bared, but it's clear from his wide-eyed expression he's not controlling his mouth and struggles against Red Knight's

control. His skin begins to blister as the internal temperature rises and he literally begins cooking from the inside out.

Lilah Deckard, on the other hand, is holding a Vial of Biotoxin and a Video Camera. Filming the encounter, she turns to the Edgerunners, and accuses them of being Red Knight. Then, she mouths, "I'm sorry" to the Crew.

Another message pops up on their Agents: "Two obituaries were published tonight. One will be retracted. You get to pick which. The rules say only one can live."

Faced with the impossible, there are a few actions the Crew can take.

- **Save Dave.** The only way to save Dave is to reset or forcibly remove the surgically-implanted Megabite. A DV 17 Cybertech Check resets the gear and gives Dave control. Alternatively, the Crew can also rip out or damage the cyberware, but doing it in a timely fashion is risky as it reduces his HP to 0 and forces an instant Death Save. As soon as Megabite is removed or disabled, Lilah

injects herself with a deadly biotoxin that kills her within seconds. **GO TO RESOLUTION (MEMORIES OF HOME).**

- **Save Lilah.** Saving the CEO results in a physical struggle for the Vial of Biotoxin, requiring someone to disarm Lilah (**SEE CP:R, PAGE 177**). When the Crew has the vial in hand, Lilah stops recording, but Dave's blood temperature rises so high his blood boils. The horrific sight forces Lilah to break down in tears. **GO TO RESOLUTION (PRICKLY CONCLUSION).**
- **Save them Both.** It is possible to save both Dave and Lilah through splitting up or clever actions. **GO TO RESOLUTION (A NEW ENEMY).**
- **Save Neither.** The Edgerunners can give Red Knight the middle finger and wrest control of the situation by deciding to leave, abandoning Lilah and Dave, calling for backup, or trying something else not listed here. This won't guarantee their names will be clear, however, and there will be consequences for their trickery. **GO TO RESOLUTION (THROWN IN JAIL).**

BY RICHARD BAGNALL



## RESOLUTION (MEMORIES OF HOME)

As soon as Dave is freed from Red Knight's control, he tells the Crew to make a run for it right before passing out. The Edgerunners dash outside moments before the building explodes—destroying whatever evidence was inside. From there, they can contact the Lost Kids to get Dave help. The Impaler meets with the Crew and escorts them back to the area that was once Home. Once filled with kids, the old location is now devoid of life, but it's clear the Crew was brought to safety. The Impaler says:

*"We found a cash card in Dave's pocket marked 'Megabite Removal Fund.' There's enough on it to pay off a Ripperdoc we know won't screw us over and get this crap out of our bodies. And word on the street is NCPD now believe the stiff wasn't even Roman Deckard. That plus the crime taking place elsewhere means you're all cleared. Laws probably not looking for you."*

Talking with Dave, after he's woken up, reveals the reason for Lilah's actions in the warehouse. Red Knight gave them instructions via her Agent: if she didn't use

the video camera to lay blame on the Crew and then kill herself, all five of the Lost Kids implanted with Megabite would die a horrible, agonizing death. Considering the charges against the Edgerunners have been dropped, Dave thinks the Red Knight was just seeing how far he could torture and push the dead CEO.

Saving Dave is the ultimate sign of trust. The Edgerunners permanently receive a 10-percent discount when purchasing goods from Home's Night Market and are granted favors from teens who just might know the streets better than they do.

## RESOLUTION (PRICKLY CONCLUSION)

Within moments, a sizable force of Lawmen, media darlings, and private security storm the building once Lilah Deckard is saved. The grieving mother addresses the press first and tells everyone how the Crew saved her life and why she was targeted. She then admits her crime and resigns as CEO from Cactus Water. Her children are both dead, and her husband left her several months ago. She sees no reason to obey Petrochem anymore.

With no family left to protect, Lilah believed she didn't care about living anymore—until the Edgerunners forced her to realize she can still do some good in the world. Lilah then announces she already spent her Cactus Water earnings on a new orphanage in Little Europe to help Night City's lost kids.

Following her PR move, Lilah Deckard explains her actions in the warehouse: Red Knight told her if she didn't videotape the accusation and kill herself, Red Knight would kill all five of the Lost Kids implanted with Megabite.

Fortunately, the Crew will be able to confirm the other four kids are alive and Lilah will use her money to help them.

She then privately pays the Crew a 500eb reward (on top of any previously negotiated fees) for "helping her see the light." Later, they also receive an anonymous message on their Agent, marked with a familiar symbol and an inscription: A red knight's helmet. The quote reads:

*"Deep vengeance is the daughter of deep silence."  
—Vittorio Alfieri.*

## RESOLUTION (A NEW ENEMY)

As soon as Dave is freed from Red Knight's control, he tells the Crew to make a run for it right before passing out. Making it out before the bomb explodes requires a DV 13 Athletics Check (or a DV 15 if carrying Dave or Lilah Deckard). Anyone caught inside as the building explodes takes 8d6 damage and is Deadly on Fire (**SEE CP:R PAGE 180**).

Assuming she survives the explosion, Lilah contacts the authorities and the media. **SEE RESOLUTION (PRICKLY CONCLUSIONS)** for more details on what she tells them and how she rewards the Edgerunners.

Lilah also ensures Dave receives medical care. At some point in the next day, the Crew is contacted by The Impaler, who asks them to meet him in Home's former location.

He thanks them for saving Dave and lets them know Lilah Deckard is ensuring Megabite is removed from all five Lost Kids. The Crew also receives a 10-percent discount from Home's Night Market.

And as the sun sets, the Crew receives a message marked with a red knight's helmet:

*"The haft of the arrow had been feathered with one of the eagle's own plumes. We often give our enemies the means of our own destruction."  
—Aesop.*

## RESOLUTION (THROWN IN JAIL)

When the Crew takes matters into their own hands, Red Knight sends up virtual flares and the law descends on the warehouse to arrest the Edgerunners for multiple crimes ranging from extortion to murder. As far as the law is concerned, they're the Red Knight.

By the time the Lawmen find Dave and Lilah at the back of the warehouse, they're both dead. The Video Camera Lilah held didn't have a Memory Chip, but evidence does magically appear later—a grainy recording of the Edgerunners entering the warehouse.

Strangely, after spending one night in jail, the Crew is set free due to "new evidence." Back home, unharmed, the Edgerunners each receive a warning via their Agent: "Forget about Red Knight, and we'll forget you."

## IF PLAYING PART TWO...

The Crew's decisions throughout this adventure affect what happens next. Their mysterious foe—Red Knight—is a practical and focused antagonist.

If the Crew abandons pursuit of Red Knight, they won't encounter them again. If, however, the Edgerunners want payback or if they got the **A NEW ENEMY RESOLUTION**, Red Knight's motivation shifts from passive aggressive to declarations of war: The antagonist is now determined to bring the Crew down before they are exposed.

Knowing Red Knight thirsts for vengeance is the key to understanding how they select victims worthy of their wrathful punishment.

**PROCEED TO ONE RED NIGHT  
TO HUNT THEM DOWN.**

NET ARCHITECTURES

▶ DELIRIUM'S NET ARCHITECTURE

*Demons Installed: None*

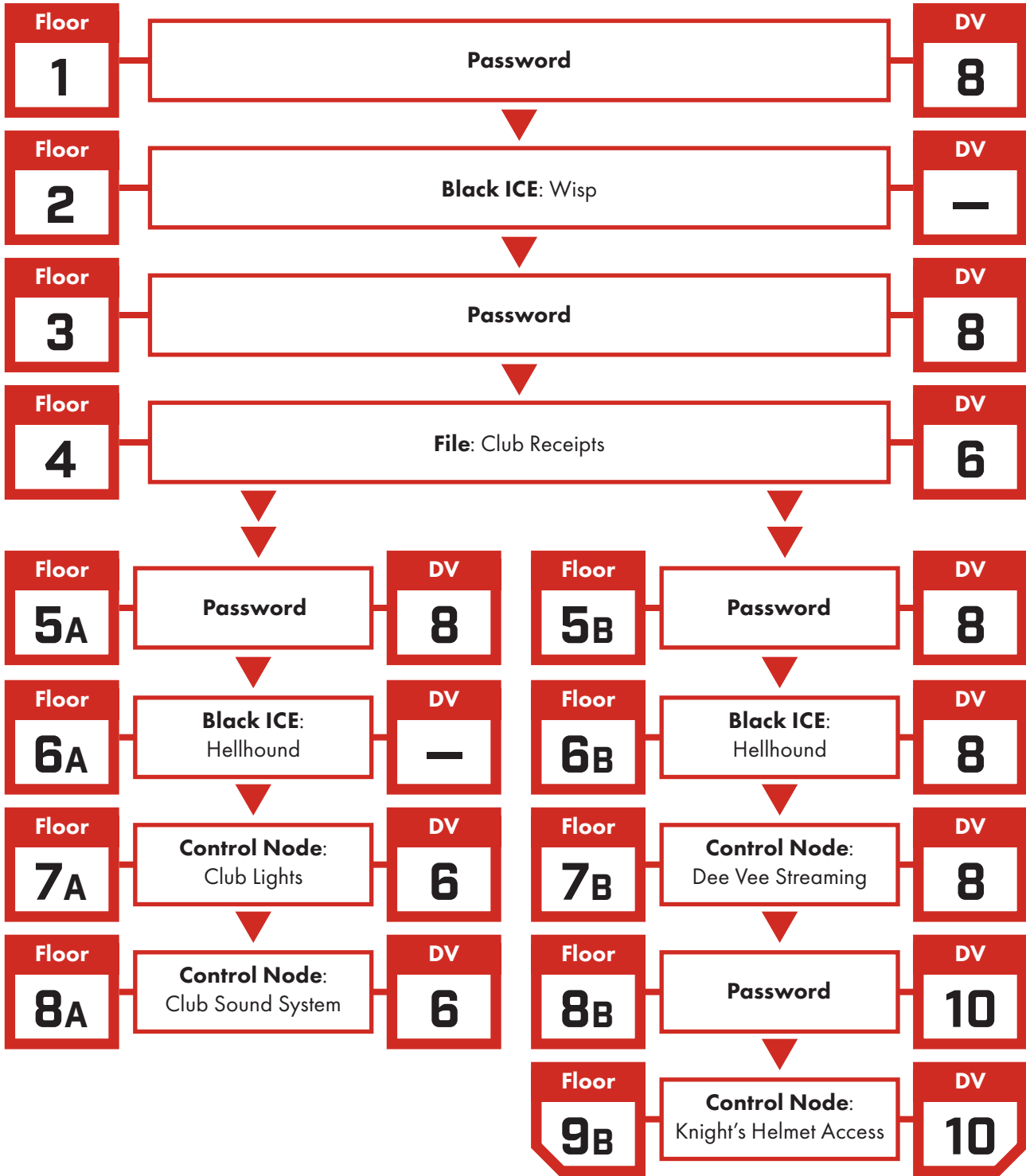

# BATHED IN RED

## NPCC STAT BLOCKS

For more information on important NPCs **SEE APPENDIX B: BIOGRAPHIES.**

SEE PAGE 186 FOR BIOGRAPHY

<b>NAME</b>	<b>THE IMPALER (REP 0)</b>		<b>SERIOUSLY WOUNDED</b>	<b>18</b>	<b>HP</b>	<b>35</b>											
<b>ROLE</b>	<b>SOLO: COMBAT AWARENESS 1</b>		<b>DEATH SAVE</b>	<b>5</b>													
<b>STATS</b>																	
<b>INT</b>	<b>5</b>	<b>REF</b>	<b>7</b>	<b>DEX</b>	<b>6</b>	<b>TECH</b>	<b>4</b>	<b>COOL</b>	<b>4</b>	<b>WILL</b>	<b>4</b>	<b>MOVE</b>	<b>5</b>	<b>BODY</b>	<b>5</b>	<b>EMP</b>	<b>6</b>
<b>WEAPONS</b>							<b>ARMOR</b>										
POOR QUALITY HEAVY PISTOL				ROF2	3d6	LEATHER (BODY)		SP 4									
MEDIUM MELEE WEAPON				ROF2	2d6	NONE		—									
<b>SKILL BASES</b>																	
Athletics 10 • Brawling 10 • Conceal/Reveal Object 7 • Concentration 6 • Conversation 5 • Education 7 • Endurance 8 • Evasion 8 • First Aid 6 • Handgun 13 • Human Perception 8 • Interrogation 8 • Language (English) 9 • Language (Streetslang) 7 • Local Expert (Old Combat Zone) 7 • Local Expert (Sewers) 7 • Melee Weapon 12 • Perception 9 • Persuasion 6 • Resist Torture/Drugs 6 • Stealth 12																	
<b>GEAR</b>																	
Heavy Pistol Ammo x8 • Flashlight • Grapple Gun • Rope (60 m/yds)																	
<b>CYBERWARE</b>																	
Upgraded Megabyte (Package containing Vampyres w/ Suction Pump, Chemskin, and Shift Tacts)																	

SEE PAGE 182 FOR BIOGRAPHY

<b>NAME</b>	<b>ASHER (REP 0)</b>		<b>SERIOUSLY WOUNDED</b>	<b>13</b>	<b>HP</b>	<b>25</b>											
<b>ROLE</b>	<b>NONE</b>		<b>DEATH SAVE</b>	<b>4</b>													
<b>STATS</b>																	
<b>INT</b>	<b>2</b>	<b>REF</b>	<b>6</b>	<b>DEX</b>	<b>5</b>	<b>TECH</b>	<b>2</b>	<b>COOL</b>	<b>4</b>	<b>WILL</b>	<b>2</b>	<b>MOVE</b>	<b>4</b>	<b>BODY</b>	<b>4</b>	<b>EMP</b>	<b>4</b>
<b>WEAPONS</b>							<b>ARMOR</b>										
LIGHT MELEE WEAPON				ROF2	1d6	NONE		—									
NONE				—	—	NONE		—									
<b>SKILL BASES</b>																	
Athletics 9 • Brawling 9 • Conceal/Reveal Object 4 • Concentration 4 • Conversation 5 • Education 4 • Endurance 6 • Evasion 7 • First Aid 4 • Human Perception 5 • Interrogation 6 • Language (English) 6 • Language (Streetslang) 9 • Local Expert (Sewers) 4 • Melee Weapon 8 • Perception 6 • Personal Grooming 8 • Persuasion 8 • Resist Torture/Drugs 4 • Stealth 7 • Wardrobe and Style 10																	
<b>GEAR</b>																	
Disposable Cellphone																	
<b>CYBERWARE</b>																	
Techhair, Upgraded Megabyte (Package containing Vampyres w/ Suction Pump, Chemskin, and Shift Tacts)																	

NAME <b>DAVE (REP 0)</b>	SERIOUSLY WOUNDED <b>13</b>	HP	<b>25</b>
ROLE <b>NONE</b>	DEATH SAVE <b>4</b>		

**STATS**

INT **2** REF **6** DEX **5** TECH **2** COOL **4** WILL **2** MOVE **4** BODY **4** EMP **4**

WEAPONS	ARMOR
POOR QUALITY MEDIUM PISTOL	NONE
NONE	NONE

**SKILL BASES**

Athletics 9 • Brawling 9 • Conceal/Reveal Object 4 • Concentration 4 • Conversation 5 • Education 4 • Endurance 6 • Evasion 7 • First Aid 8 • Handgun 8 • Human Perception 5 • Interrogation 6 • Language (English) 6 • Language (Streetslang) 9 • Local Expert (Sewers) 4 • Melee Weapon 8 • Perception 6 • Persuasion 6 • Resist Torture/Drugs 4 • Stealth 7

**GEAR**

Medium Pistol Ammo x8 • Disposable Cellphone

**CYBERWARE**

Upgraded Megabyte (Package containing Vampyres w/ Suction Pump, Chemskin, and Shift Tacts)

NAME <b>FLAXX (REP 0)</b>	SERIOUSLY WOUNDED <b>13</b>	HP	<b>25</b>
ROLE <b>NONE</b>	DEATH SAVE <b>4</b>		

**STATS**

INT **2** REF **6** DEX **5** TECH **2** COOL **4** WILL **2** MOVE **4** BODY **4** EMP **4**

WEAPONS	ARMOR
LIGHT MELEE WEAPON	NONE
NONE	NONE

**SKILL BASES**

Athletics 9 • Brawling 9 • Conceal/Reveal Object 4 • Concentration 4 • Conversation 5 • Education 4 • Endurance 6 • Evasion 7 • First Aid 8 • Human Perception 5 • Interrogation 6 • Language (Spanish) 6 • Language (Streetslang) 9 • Local Expert (Sewers) 8 • Melee Weapon 8 • Perception 6 • Persuasion 6 • Resist Torture/Drugs 4 • Stealth 7

**GEAR**

Disposable Cellphone

**CYBERWARE**

Upgraded Megabyte (Package containing Vampyres w/ Suction Pump, Chemskin, and Shift Tacts)

# BATHED IN RED

SEE PAGE 193 FOR BIOGRAPHY

NAME <b>TWO THEE</b> (REP 1)		SERIOUSLY WOUNDED <b>13</b>	HP <b>25</b>														
ROLE <b>NONE</b>		DEATH SAVE <b>3</b>															
<b>STATS</b>																	
INT	4	REF	6	DEX	4	TECH	4	COOL	3	WILL	3	MOVE	3	BODY	3	EMP	3
<b>WEAPONS</b>								<b>ARMOR</b>									
MEDIUM MELEE WEAPON								ROF2	2d6	NONE		—					
NONE								—	—	NONE		—					
<b>SKILL BASES</b>																	
Athletics 10 • Basic Tech 10 • Brawling 6 • Bureaucracy 6 • Concentration 5 • Conversation 6 • Education 10 Electronics/Security Tech 10 • Endurance 5 • Evasion 6 • First Aid 6 • Human Perception 5 • Language (Oromo) 6 Language (Streetslang) 6 • Library Search 10 • Local Expert (Morro Rock) 6 • Melee Weapon 8 • Perception 6 • Persuasion 5 Stealth 9																	
<b>GEAR</b>																	
Flashlight • Techtool																	
<b>CYBERWARE</b>																	
Cybereye w/ MicroOptics, TeleOptics • Upgraded Megabyte (Package containing Vampyres w/ Suction Pump, Chemskin, and Shift Tacts)																	

SEE PAGE 187 FOR BIOGRAPHY

NAME <b>LILAH DECKARD</b> (REP 4)		SERIOUSLY WOUNDED <b>20</b>	HP <b>40</b>														
ROLE <b>EXEC: TEAMWORK 5</b> (BODYGUARD, DRIVER)		DEATH SAVE <b>5</b>															
<b>STATS</b>																	
INT	5	REF	7	DEX	7	TECH	3	COOL	6	WILL	7	MOVE	5	BODY	5	EMP	5
<b>WEAPONS</b>								<b>ARMOR</b>									
EXCELLENT QUALITY MEDIUM PISTOL								ROF2	3d6	SUBERMAL (HEAD)		SP 11					
NONE								—	—	SUBERMAL (HEAD)		SP 11					
<b>SKILL BASES</b>																	
Accounting 11 • Athletics 9 • Brawling 9 • Bureaucracy 11 • Business 11 • Concentration 9 • Conversation 11 • Deduction 11 Education 11 • Evasion 13 • First Aid 5, Handgun 13 • Human Perception 11 • Language (English) 9 • Language (Streetslang) 7 Lip Reading 11 • Local Expert (Exec Zone) 7 • Perception 9 • Personal Grooming 10 • Persuasion 12 • Stealth 9 Wardrobe and Style 10																	
<b>GEAR</b>																	
Medium Pistol Ammo x12 • Businesswear Jewelry • Memory Chip x2 • Radio Scanner/Music Player Smart Lens (contact lens with Chyron installed, linked to Internal Agent)																	
<b>CYBERWARE</b>																	
Biomonitor • Contraceptive Implant • Cyberaudio Suite w/ Internal Agent • Subdermal Armor																	



## BACKGROUND (READ ALOUD)

Every time you close your eyes, you sweat blood. Can't wash it off. Can't Smash it out. Drowning you in guilt. Hot, slippery blood pooling 'round your ankles. You draw your blade—you don't know why—and yell defiantly at the rising tide. Just as you lunge toward it, the bloody wave parts like the Red Sea. Only that's not Moses. A knight in red armor gallops toward you on horseback, waves of fresh blood crashing behind them, ready to—

"Hello?" you hear yourself say as your Agent chimes. "Got a job for you, choomba," says the voice on the phone. Oh good, you think. A healthy distraction. "Hit me," you say. "Ready for a little knight hunt?" Your Fixer thinks they're funny, but they weren't at that warehouse that night. You fall silent. Then, with arctic ice in your voice, you reply, "Yeah, I'm ready."

## THE REST OF THE STORY

Every Crew knows most jobs are not risk-free, but tonight's mission is not only dangerous—it's downright deadly.

This is a follow up mission to **Bathed in Red** (PAGE 127). In that mission, the Crew encountered a bloodthirsty vigilante called Red Knight. The mysterious antagonist created chaos that left the Edgerunners confused and traumatized. Every heinous crime Red Knight committed happened in front of the Edgerunners—who were then framed for much of it. Tonight, the Crew must chase that bastard down in the name of justice ... and a sizable bounty.

But first, the Crew must meet a Biotechnica bigwig in the Pleasant Valley Apartments for the lowdown about the job. On the way, the Edgerunners can swap theories about Red Knight's identity and dig up more details about the Deckard family. When they park at the site, nothing's amiss—thanks to the location's unusual tech-free nature. It isn't until they find out who their client is that reality hits: The Exec's none other than Lilah Deckard's missing husband, Michael, and his mistress/secretary/now-fiancée Anya: the nature-loving clubber who was searching for Roman Deckard back at Delirium.

Deckard offers a bounty and a stipend for one-month's apartment living if the Edgerunners hunt down Red Knight and avenge his family. After the Crew

finalizes details, Michael strongly suggests they eat dinner at Mister Rice Guy, located next door to find their next clue.

As the Crew enjoys the self-serve restaurant, its virtual personality, Hime Cat, offers them a treat. Their pleasant evening doesn't last long when Raegan, lead singer of the popular band Protocon, publicly accuses the Crew of being Red Knight. Shanna, de facto band manager and drummer, suggests the diners take the street fight outside.

When the dust settles, Raegan apologizes, realizing that the Edgerunners are also victims of Red Knight. Accusations turn into pleas for a team-up to swap information and plan their next move. Protocon's goal is simple: They're scheduled to perform outdoors at Night City Plaza tonight and have written a special song to draw Red Knight out in the open. After the concert prep, Protocon takes the stage while the Crew scans the crowd for Red Knight. Following Raegan's performance, a drone disrupts the show, forcing the Crew to get a handle on the crowd and the band's safety.

Red Knight will either be taken down at the plaza or eventually chased to their base of operations: Seral Grove, a secret memorial plaza dedicated to housing the city's elite. Either way, the Crew must decide. Will they reveal the hidden truth behind the Red Knight or hide it all away like their employer wants. No matter what they choose, this is the Crew's only chance to end the **red** night they're all trapped in, once and for all.

## THE SETTING

The Crew's night begins as their Fixer's tip sends them to the Pleasant Valley Apartments in Pacifica Playground. Eight-stories tall, the red-bricked building has a nostalgic Brownstone design, nestled next to Pursuit Security Incorporated's solar-powered administrative offices. To enter the art deco-designed apartment building lobby, tenants punch an entry code to unlock the security doors.

Next door to the Pleasant Valley Apartments is Mister Rice Guy, an automated sushi restaurant known for its black rice roll. The establishment recently expanded their menu, hours, and services. Diners can reserve tatami dining rooms in a zen garden for 100eb (Premium) per hour. Open 24/7, the restaurant also



# ONE RED NIGHT

- **Review the Facts:** Search the Data Pool, listen to street rats, build a timeline of events, grab some gossip, contact/spy on Lawmen, talk to witnesses, review tactics, form a plan, call an expert, and so forth.
- **Take Inventory:** Clean weapons, reload, buy ammo/weapons, run diagnostics, get extra chips, swap out installations, check plugs, balance accounts, and so forth.
- **Inspect their Vehicle:** Check the tires, fuel up, stash extra gear/ration chips, clean out those Kibble wrappers and empty Smash cans, test the alarm system, change the oil, and so forth.
- **Get Medical Help:** Visit a Medtech, get new cyberware, heal up, and so forth.
- **Grab a Quick Snack:** Visit a Vendit or bodega, go out for a drink of five. Stash some extra Kibble in the car.

Halfway through their night's prep, one of the Edgerunners receives a message on their Agent containing a Garden Patch link. The Garden Patch, titled "Red Knight's Chessboard" contains a single video. The narrator, in a box in the lower left of the video, is a digitized knight in red armor

*What you're seeing here, according to the captions, is Michael Deckard's nephew, a sweet college kid enrolled in Night City University's honors program, being attacked by a trio of what appears to be clawed, red drones on campus. The drones, emblazoned with the mysterious Red Knight's helmet, use whirling blades to hack the poor kid apart.*

The link must have been sent to media outlets as well, as most news channels are now running the footage. The drones are identified as belonging to Red Knight. A summary of the recent ransomware case at Delirium and the murder of Roman Deckard is mentioned.

Different media outlets list the handles of different members of the Crew as being connected with the Roman Deckard case and possible suspects. Red Knight not only sent the video link to the media but also gave them background on Roman's murder and the Crew's involvement.

A successful Human Perception or Tactics Check (DV 13) makes it clear to the Crew: Red Knight knows what they're doing and has declared war on them. At this point, any Edgerunner with media contacts, or who is actually a Media, might get a call asking for more information, a statement, or an offer to sell their life, streamed murder confession for 1,000eb.

The clock is ticking and the Crew had better move. If the Edgerunners don't have transportation of their own, they can try public transport, hitch a ride, or call a cab.

## GO TO DEV (INTO THE PACIFICA)

### DEV (INTO THE PACIFICA)

The Crew arrives at the Pleasant Valley Apartments. Michael sends a message telling the Crew to park on the street, gives them an entry code, and then invites them to Unit 8C.

Entering the antique lobby gives the Crew pause as if they've stepped out of a time machine. The front lobby is decorated in an art deco-meets-traditional Chinese theme in black, ivory, and gold trim. Sectional couches sit next to



Red Knight

BY HÉLIO FRAZÃO

tall, bamboo plants; further in, a gold-fated elevator and a door leading to a spiral staircase. Elaborate, hand-inlayed scenes depicting swans in flight invoke a peaceful, calm feeling. Painted on the walls are red characters—pinyin, at first glance—relaying quotes from philosophers like Ah Lam: “Technology is not evil, and neither are humans. Humans who weaponize technology against other humans are the real enemy. That is why I say no to technology.” And Wei Ling’s popularized quote: “Earth is. We are of the earth. Return and rejoice. Naturally.”

Edgerunners can either take the antique elevator or trudge up the spiral staircase to the eighth floor; both are unoccupied and don’t have any tenants milling around. The Crew can search around but won’t come up with anything suspicious. The building and its tenants are simply calm and quiet enough to make an anxious Edgerunner wonder when a rogue bullet might buzz by.

Knocking on the door to 8C, the Edgerunners might be surprised to find Michael Deckard and Anya, the naturalist from Delirium who claimed she was Roman’s “friend,” both standing in their bathrobes. Michael is taller and fitter than expected but is clearly decades older than Anya. She blushes.

*“You didn’t know we were together? I suppose there’s no easy way to announce happy news, is there? Yeah, so obvi... to me, I mean. I know we’re supposed to wait for all the paperwork to go through and everything but we’re gonna be married soon and start a new company and put out a new health water! Isn’t that great? And this time, we’re going to take Mother Nature’s approach and purify the water in sunlight before selling it. I can’t wait to ... oh, we’re so glad you’re here. Honey, I put some clothes for you on the bed. I suppose you want to—”*

While Anya babbles excitedly, her fiancé and her new job, Michael Deckard, doesn’t say a word. A Human Perception Skill Check gives savvy Edgerunners a clear impression of the corporate Exec: Michael carries himself like a man who knows when to keep his mouth shut and when to take advantage of a situation.

Michael struts around the sparse two-bedroom/two-bath apartment as if the Edgerunners don’t exist. Then, he excuses himself for a minute and retreats into his bedroom to change. When he re-emerges, he’s dressed in a Torrell and Chiang suit. Extending his hand, Michael offers:

*“I have a job for you. By now, you’ve seen the footage circulating of my nephew. Red Knight is targeting my family again, and I don’t have a choice. I have additional information for you, but know this: They must be stopped. I’m prepared to pay you 3,000eb if you find and kill them, and will hand over the keys to this apartment for a month. This apartment should adequately serve your needs. I’ve lost my children and my nephew, and if this keeps up, Biotechnica will drop me because of bad publicity. I need this job. You understand. Maybe you haven’t lost someone before, but grief is a funny thing. I don’t want Red Knight caught. I want them **dead** and this whole mess **gone**. Are you ready to put down Red Knight?”*

Taking Michael’s offer grants the Crew immediate access to Unit 8C and all amenities for one month, including free underground parking. The Edgerunners can refuse the apartment, but Michael’s offer will be harder to turn down. He wants payback for what Red Knight did to his family, and he assumes the Crew does as well. If they waffle or refuse Michael, Anya points out Red Knight leaked the Crew’s name to the press and probably won’t stop hunting them. At that point, Michael steps in and tells the Edgerunners the only way to catch Red Knight is with his help.

Once the negotiations are over and the Crew makes their decision, Michael strongly recommends dinner at Mister Rice Guy, and reminds Anya she’s running late to her massage appointment. He also mentions he prefers regular updates as they find new information, if possible.

If the Edgerunners turn him down, Michael suggests no important decisions are made on an empty stomach and hands them 50eb vouchers for the restaurant. Of course, the Exec is too busy to come with them, but he will strongly suggest they dine there. The Crew can always accept the offer later, after dinner.

As soon as the group hits the lobby, Michael and Anya wave goodbye and quip: “Your first clue? I just gave it to you.” The Crew is free for dinner. Head over to Mister Rice Guy and the **CLIFF (SERVED WITH LUCK)**.

## CLIFF (SERVED WITH LUCK)

Walking into Mister Rice Guy is like finding yourself in a Rube Goldberg machine—only you’re the ball. The restaurant is fully automated and is so colorful, even

## THAT LITTLE MINX

*Anya is engaged to Michael, but her lovesick act is just that—a performance worthy of a Rockerboy. Of the two, Anya is much more likely to talk, but only if she's separated from her fiancé. Alone, she admits Michael asked her to drop by Delirium to “look for my son, I've heard he's hanging out there.” She's not even remotely in love with Michael, but agreed to marry him anyway. It's easier than admitting they're just using each other.*

## SPONSORED BY BIOTECHNICA

*According to rumors, Biotechnica has covered Magnus Haggard's debts and have purchased a laughable .002% stake in Delirium. The question on everyone's mind is... why?*

## MISTER RICE WHO?

*The restaurant is conveniently upscale and incredibly well stocked. Some diners have tried—and failed—to find out who owns both buildings. The digital trail is buried in a “who's who” of corporate buyouts and shell companies dating back several years.*

fashionistas do a double take. The only trick is: Self-serve only works one at a time, so stand in line, choomba.

*7:30 p.m. Got a lead on a few thousand eb, temp apartment, and dinner courtesy of Michael Deckard. You wonder what Biotechnica has on him—or vice versa. 'Cept, he hasn't dropped any clues yet, and Red Knight is still out there. Convenient or just shitty timing? How sus. Free food sounds nice—even if it's unagi-flavored Kibble. You stroll into Mister Rice Guy and can't find a server anywhere. Where do you sit again? A scrolling message sign reads: “Welcome! Help yourself! Read the rules before ordering.” Well, okay then.*

Thankfully, there are scrolling message boxes to help you order, pay, and find seating.

## RULES FOR ORDERING

1. Hello! Form a queue. Don't forget to smile! You're on camera. \*click\*
2. Access to an Agent is recommended. Please link to find additional menu items and information about our Dining Rooms. Vendits located near the exit in the back. Or just order, eat, and pick any seat!
3. Are you a Pleasant Valley Apartment resident? Do not worry. For an additional 50eb, your meals will be added to next month's rent.
4. Did you find an unsealed plate? Don't eat it! Report it. Your account will be credited.
5. **Pink** : 200eb. **Blue** : 150eb. **Green** : 100eb. **Orange** : 50eb. **Yellow** : 10eb
6. Plate tampering is forbidden at Mister Rice Guy. You buy what you take.
7. Mister Rice Guy does not like crime. You steal or break it, you buy it. Punch another diner? Lawmen will be called.

A swirling maze of conveyor belts present different-colored neon plates. It's clear from the plate's colors the quality increases with the price. Edgerunners who have linked their Agents and make use of the voucher given to them by Decker also receive notice their meals come with a special Lucky Treat.

## EXAMPLE MENU ITEMS

- **Pink**, 200eb. Real fish, rice, vegetables. Dragon sushi rolls, maguro sashimi, pork-and-sansho ramen, rice bowls. Cold and hot. Available 200ml drinks with purchase: high-end sake, whiskey, and rice wine. Filtered water or loose-leaf teas.
- **Blue**, 150eb. Vegetarian selection. Agedashi tofu. Natto Tamaki sushi rolls. Shitake mushroom ramen. Cold and hot. Available 200ml drinks with purchase: mineral water, plum wine, organic green tea.
- **Green**, 100eb. Good Prepaks. Real rice with synthetic proteins and dehydrated vegetables. Egg-fried rice. Shrimp tempura roll. Hot only. Available 200ml drinks with purchase: a variety of hot tea bags.
- **Orange**, 50eb. Generic Prepaks. Carb-or-broth heavy. Egg drop soup and miso ramen. Hot only. Available 200ml drinks with purchase: pre-brewed green, orange pekoe, or black tea.
- **Yellow**, 10eb. Kibble. Variety of flavors with a South Asian culinary flare. Wasabi, Sriracha, Green Tea, Honey, Oyster, Sweet (Condensed Milk). Available 200ml drinks with purchase: foil-packaged water.

The flavored Kibble is sealed in a foiled bag and can be taken “To Go!” The other meals are presented on the plate. The public seats near the front windows are open; the bar on the left is full of diners. Rooms can be rented for 100eb (Premium) per hour.

## ▶ HIME CAT'S LUCKY TREAT

1d6	Lucky Treat
1	Hime Cat says, "Oh no, you've run out of luck!" Subtract up to 2 LUCK from the Edgerunner's pool. The LUCK will refresh at the beginning of the next session as normal.
2	Hime Cat says: "Nyan! Relax with a refreshing cup of tea! Courtesy of Mister Rice Guy." The Edgerunner receives a voucher for a free pre-brewed green, orange pekoe, or black tea!
3	Hime Cat purrs loudly and says "Your lucky Megacorp is..." followed by a random Corp logo.
4	Hime Cat asks, "Have you said hello to your fellow diners? They might be interesting!" If the Edgerunner looks at the other patrons, have them make a DV 9 Perception Check. If they succeed, they spot one of them is wearing a pin with the Inquisitor logo on it.
5	Hime Cat says: "Nyan, here's an extra treat! Take 100eb off your next order. Courtesy of Mister Rice Guy." The Edgerunner receives a voucher for 100eb at Mister Rice Guy.
6	Hime Cat says, "You're overflowing with luck!" Add 2 LUCK to the Edgerunner's pool, even if that raises their LUCK above their normal maximum. This extra LUCK must be sent by the end of the session or will be lost.

As the Crew enjoys their first meal, the restaurant's virtual personality—Hime Cat—messages their Agents asking them to open their Lucky Treat.

To open Hime Cat's Lucky Treat, the Player rolls a 1d6. Hime Cat is so lucky, no two Edgerunners will get the same result.

Once the Crew has opened their Lucky Treats, they might want seconds.

*Seconds? Yes, please! Screw your rent. You walk up to a conveyor belt and wait for that shrimp tempura Prepak with real goddamn rice to roll past you. Before you have a chance to grab it, someone taps you on the shoulder. You turn around, pretending to be offended, but just blink. Is that... Raegan Halley from that electric punk band Protocon? The one Bes Isis keeps raving about? Shit! Just act cool, choomba. Your mouth opens but you got nothin' to say. That's when Raegan whispers in your ear: "I know who you are, Red Knight. You're mine."*

The Edgerunners take one Action to size up their accuser. Raegan's bandmates, Shanna and Kinneth, pull their chairs back and stand behind her. This trio of Rockerboys form the popular electric punk band Protocon. They are:

- **Raegan "Pro" Halley.** Lead singer. White spiked hair, half-shaved head. Neon purple skin. Wears a heart choker and a strange pendant. Neon punk aesthetic. More dangerous than

she appears. Those high-heeled boots? Could stash a Light Melee Weapon or two. Has a fiery personality and leaps without thinking.

- **Shanna "To" Doole.** Drummer. Has a pair of glowing drumsticks stashed in her boots. Red-and-black plaid, fishnets, traditional punk aesthetic, impressive 'fro. Confident and patient, oozes leadership.
- **Kinneth "Con" de Léon.** Guitarist. Gripping a wireless electric guitar that could double as a weapon. Ripped goth-meets-vintage punk aesthetic with a whole lot of skulls and light tattoos. Shy, friendly smile bordering on cocky. Stands behind the other two bandmates. Definitely the "whatever you think's best" type of friend.

Following Raegan's accusation, the singer steps back, her voice rising to a shout:

*"Asshole! I finally tracked you down, you heartless fucker. I thought dating Dillon Murphy was bad. But you? You're something else. You killed Layla. You murdered her brother. God-only-knows how many other people died because of your shit. Is it worth it, Red Knight? After all this, do you really want to..."*

A Human Perception Skill Check reveals Raegan is bluffing for time. Either she knows Lawmen are on their way or she's messaged the band's bodyguards (use **Bodyguard**, [PAGE 172](#)) to back them up.

# ONE RED NIGHT

Red Knight's reputation has grown so much that the other patrons eye the Edgerunners suspiciously. Several diners stand up and pull out their munitions.

Shanna yells: "Let's take this outside! I like my sushi, choombas. I'm sure you do, too."

Halfway through her command, four gang members (use **Inquisitor Mooks**, PAGE 17) wearing Inquisitor pins (Perception DV 15 to notice) grumble at the Edgerunners. The cyberphobic Inquisitors live in the Pleasant Valley Apartments and target any character with cybernetic implants to "save their soul."

Caught between a misunderstanding and a cultish gang, the Crew must think quickly before the situation gets out of hand. They can:

- **Target the Inquisitors:** Pleasant Valley Apartments might be a safe place for technophobes, but there's nothing in the brochure that says street fights are off-limits. Targeting the Inquisitors is the choice everyone wants to make but is too afraid to—especially since the band has subdermal implants they don't want forcibly removed. Taking out the gang members

impresses Protocon and grants a +1 bonus to any Social Skill Checks made against the band by one for the rest of the mission. Note, it doesn't take much to provoke the Inquisitors to carry out their holy mission. If the GM wants a real rumble here, all it takes for the Inquisitors to attack is for them to notice obvious chrome on a member of the Crew.

- **Battle the Band:** The Edgerunners can attack Protocon. At the top of the second Round, the band's bodyguards appear, adding to the tension as well as firepower. Before things escalate into a real firefight, Shanna asks: "Well, are you Red Knight or aren't you?" to try and defuse the situation.
- **Fight Strategically:** The Crew can hold their punches and pretend to throw down with the band and angry patrons. (The Edgerunners fight the Inquisitors as normal and are met with cheers. Because nobody likes those guys.) After two Rounds of comical stunts, Kenneth throws his hands up. "Truce?" This strategy successfully convinces Protocon they're probably not Red Knight.
- **Staredown:** If a member of the Crew wins a Facedown against Raegan, Protocon will back down long enough to have a real conversation.
- **Run Away:** If the Crew has a vehicle, it is parked on the street. Plus, they just got access to a nice apartment in a secure building. They can ditch the fight by running out the door, but cross paths with Anya. Filling her in triggers an interesting detail: She recognizes Raegan as Layla Deckard's girlfriend and suggests they must know something. The band's giving chase.

If the Crew's stuck, remind them their goal isn't to dodge a fight or show how badass they are—it's to convince Protocon they've accused the wrong suspects to find out what they know. When one or more band members is no longer convinced of the Crew's guilt, **GO TO DEV [SWEET RIDE]**.

## DEV [SWEET RIDE]

No matter the fight's outcome, the streets are quiet, and there's no sign of local Lawmen despite Mister Rice Guy's rules. Once Protocon realizes the Crew isn't Red



BY DIEGO MARTINEZ

Raegan "Pro" Halley

Knight, they break up the crowd and offer them tickets to tonight's Night City Plaza Concert. The Crew can also take a moment to check in with Michael Deckard and ask if he knows Raegan; he'll say that she's why he sent you to Mister Rice Guy in the first place. Congratulations on finding your first clue.

Before they leave, Raegan approaches the Crew and confesses:

*"Sorry. Look, I thought that... well, it's just that... after Layla died, I started getting messages from Red Knight, begging me for any data I had on her. Photos. Recordings. When I didn't deliver, they started sending nasty messages and messing with our gigs. So, we set up an anonymous hotline for info. If the data were solid, the informant would get a lifetime's worth of free concert tickets. Then someone sent us an anonymous message, saying Red Knight would be at Mister Rice Guy tonight. To look for the Edgerunners connected with the case."*

Edgerunners paying attention notice Raegan mentioned Layla. No Check is required to confirm that Raegan is referring to Layla Deckard, Red Knight's first victim.

Appropriate Social Skill Checks encourage Raegan to better trust the Edgerunners with what she knows. The Rockerboy can confirm or reveal that:

- At Night City University, Layla was studying to be a marketer, but wanted to be a Rockerboy.
- Layla was openly polyamorous and pansexual. Raegan was one of her partners. Another was a loudmouth professional protester named Dillon Murphy.
- Layla often argued with her parents, but did have a supportive older brother named Roman and lots of great friends. After Layla's death, Roman dropped off the grid. Raegan hadn't seen or heard from him before his death.

- Layla's life changed suddenly after she got the Cactus Water spokesperson gig. Her lifestyle went from Kibble to Fresh Food almost overnight. Everyone knew her parents got her the job, and the other students resented her for it.
- Red Knight used deep fakes, cyberbullying, and eventually drugs to ruin Dillon Murphy's life, pushing him to the edge.
- Raegan and Layla had just broken up the night before she died because Layla wouldn't dump the increasingly unstable Dillon.
- Dillon Murphy killed Layla then himself in a murder-suicide. Raegan blames Red Knight for pushing Dillon into it.

The Crew is encouraged to share what intel they have with Raegan. A quick Human Perception DV 10 highlights how close Shanna is paying attention, and how disinterested Kinneth is. Shanna cares deeply for Raegan, but never met Layla. Kinneth cares too, but he met Raegan's girlfriend and thought she was just another rich girl.

As the conversation winds down, Kinneth blurts out:

*"We're setting a trap for Red Knight. Wanna come? Got room in our supercar. Top down. 200 mph. Nothin' like it."*

Kinneth tells the Crew their concert, tonight, at Night City Plaza in The Glen is bound to draw Red Knight since he's cyberstalking Raegan. They've written a special song to lure Red Knight out into the open and leaked the title on the Data Pool. If the Crew doesn't buy into Protocon's plan, Shanna offers to hire them for 500eb.

The Crew is free to jam themselves into Protocon's sweet convertible (use **High Performance Groundcar, CP:R, PAGE 190**) or take their own vehicle. Then they're back on the road, racing Protocon to Night City Plaza as friends instead of enemies.

## PUT YOUR HEART INTO IT

*Influencers know Protocon can't agree on anything—even romance. Despite this, most fans would be surprised to know the Rockerboys have a no-gimmick approach to love and their motto is "connection before seduction." They are all polyamorous and pansexual. That said, Raegan is open to "anything," Shanna has a friends-first approach, and Kinneth is usually turned on by the smartest person in the room.*

**GO TO CLIFF (AXES OUT)**



BY JEFFREY McDONALD

## CLIFF (AXES OUT)

The ride to The Glen is fun—for a change. The Crew notices that whenever Protocon whizzes past Lawmen in their convertible, the police sit quietly twiddling their thumbs. Being famous in Night City has its perks, it seems.

Crews who comment about the band's popularity earn an additional piece of intel: Raegan fired their band manager and road crew a few days ago. Normally, the band does have technical help and support from a team of people trained to manage their media presence and performances. This time, they have their bodyguards but not much else.

Raegan isn't a fool and doesn't want to involve her road crew—but she does want to draw Red Knight out into the open even if it means putting the band's lives at risk. Unfortunately, she's also wildly inexperienced and has never been in a violent fight herself.

Before work on the concert begins, Raegan takes the Crew aside and speaks to them.

*"I don't know your intentions are but, you know, I have goals here. I want to know who Red Knight is. I want to know why they targeted Layla. Hell, I want the whole world to know why. I want this whole crappy business yanked out into the light and purified by the sun. I want truth, choomba. Help me, okay?"*

The crowd's mood is important to this scene. Unhappy crowds boo, trample flowers and grass, climb statues, wreck fountains, throw Kibble, even flood the Data Pool with shitty reviews. Happy crowds take Protocon's lead, gifting the Crew with a sizable weapon to use against Red Knight.

At the beginning of this scene, the Night City Plaza Crowd has a neutral or zero rating. Crowd ratings cannot rise higher than 2 but can go lower than -2. The crowd is fickle, after all!

To affect the rating, Edgerunners can help with crowd control, sound management, or special effects before the band starts performing at 10:00 p.m. Additional Actions to influence the crowd's mood inspired by the Crew or overhead gossip may be taken during Protocon's performance.

## ▶ NIGHT CITY PLAZA CROWD MOOD

Rating	Effect on the Crowd
-2 or lower	<b>This concert sucks and I demand a refund. Now.</b> The concert transforms into a riot and attacks the stage. Anyone exposed to the riot must succeed at a DV 13 Endurance or Evasion or Check or take 4d6 damage.
-1	<i>Uh, the song selection is not what I expected.</i> <b>Bored now. Must leave.</b> The rush of people leaving makes it difficult to move through the crowd. Moving through the crowd requires a DV 15 Athletics Check.
0	<b>Meh.</b> Crowd isn't happy or sad. Only a minor obstacle. Moving through the crowd only requires a DV 13 Athletics Check.
1	<b>Well, tint my neon and call my Fixer!</b> Crowd responds as if Protocon succeeded at a Charismatic Impact Check at their Raegan's Rank.
2	<b>I would die for Protocon!</b> Crowd is super hyped and will respond as if Protocon succeeded at their Charismatic Impact Check at Rank 9.

- Control the Crowd with Raegan:** The stage is small and can be quickly surrounded. Raegan points out the Crew needs to secure the perimeter and build a 20 m/yard buffer zone for her bodyguards. Securing the Area discourages fans from rushing the stage. Using nearby concrete barriers is the best way to do this but will require some creativity to move them into position. They can't be moved by individuals with anything less than BODY 10. Succeeding means the crowd won't rush the stage if things get ugly.
- Check Power/Acoustics with Shanna:** Tech-savvy Edgerunners can help Shanna check the band's acoustics to repair and maintain her gear so the song can be heard with a DV 13 Electronics/Security Tech Check. Great acoustics lift the crowd's mood by 1. Failure means the acoustics suck and the crowd's mood drops by 1.
- Set Up Special Effects:** Kinneth needs help figuring out on-the-fly effects since there's no tech crew. The guitarist can grab people from the crowd to act as backup dancers, mess with the lighting, use cheap Glow Paint, etc. A show-oriented Edgerunner can direct this impromptu theater group. The right effect matters to the crowd. Add or subtract mood points based on the success or failure of an appropriate Skill Check.



## PROTOCON'S NET

Protocon makes use of a NET Architecture (SEE PAGE 167) to help control their sound and lights. Once Layla's name is mentioned, Red Knight breaks into the NET Architecture and messes with the Control Nodes, causing the malfunctions. If the Crew has a Netrunner, they can enter the NET Architecture as a friendly, meaning they can sail through the password and the Black ICE present won't see them as a threat (though they also won't obey the Netrunner's commands). Red Knight safely Jacks Out after a Round or two of combat or if the equipment is fixed and the song begins.

## CROWD GOSSIP

Edgerunners can also check in with the crowd and listen to the gossip. Here's some of the buzz they might hear, and how it could affect the Mood Rating.

- Oooooooh, I just love them so much. Think Protocon is gonna play "Put a Bolt in It"? It's such a fan fave! **+1 to the mood if this song is played.**
- Kinneth is so cute I can't stand it. How come he doesn't get a solo? He should! I want to hear him grind that axe! **+1 to mood if Kinneth plays a solo.**
- I'm probably the only fan here that hates those light-up drumsticks Shanna uses. I get such a headache watching her play. **No effect on crowd if Shanna changes her drumsticks.**
- Everybody says Protocon is so predictable, but I don't agree. Just 'cause they never switch it up and play a different genre doesn't mean they're "old." More like classic! **-1 to the mood if they don't try anything new.**
- Raegan ... oh, I'd kill to be up on that stage. You know how cool it'd be if she'd let fans sing with her? Of course, nobody else but me... **-1 to the mood if Raegan tags the crowd. Jealousy. It's a thing.**

## LET'S ROCK!

After helping the band with the "gritty work," Crew members who can prove they have solid Play Instrument or Dance Skills are invited to join the band on stage. Success on a DV 15 Skill Check improves the crowd's mood, while a crappy song makes them restless. Add or subtract 1 mood point to mark where the crowd stands.

To increase the difficulty, the Crew can spot a few troublemakers (gang members, drug dealers, pickpockets, etc.) when

they scan the crowd and turn them over to Protocon's bodyguards. Use an appropriate Mook (SEE CP:R, PAGE 412) to switch up the challenge for the Edgerunners. Removing problematic fans in a badass but not overly violent way positively impacts the crowd's mood, raising it by 1. Bringing out guns, seriously injuring, or killing someone drops the crowd's mood by 1.

After the first couple of songs, Protocon belts out the neoclassic "Electric Nights" then brings the mood down a bit. Raegan fingers a pendant around her neck, then tells the crowd her next song is dedicated to her lost love, Layla Deckard. The second Layla's name is mentioned, the band's equipment starts malfunctioning and they look to the Edgerunners for help restoring power, lowering the crowd's mood by 1. When appropriate Skill Check puts the lights back on, the crowd cheers, boosting their mood by 1.

Raegan then leans into her microphone and cues the Edgerunners to pay attention. Then, she sings.

*In whispers I hear you / The call of your ghost  
In tears I feel you / That cry of your soul  
Can you forgive me / For letting you die  
Can you release me / And just say goodbye?  
By dawn I'll see you / A mere hologram  
Sunrise I'll feel you / A leaf in a grove  
Can you forgive me? / Oh, will you help me?  
Ah, please just save me / Turn off the light  
Oh, please just save me / Stop the Red Knight*

During the song, if the Crew succeeds at a DV 15 Perception Skill Check, they notice a tall, hooded figure at the edge of the crowd reacting oddly to the lyrics, as if the song were written for them. The figure is at the head of the crowd, against any barriers (and within 8 m/yds of an Access Point for the band's NET Architecture).

Interrupting Raegan automatically drops the crowd's mood by three; with nothing but "tall," "brooding," and "hoodie" to go on, there are too many potential suspects

to shake down. As the song finishes or if it becomes clear they've been made, the figure disappears into the crowd along with several other characters who could be mistaken for a dangerous criminal.

Seconds later, a drone flies over the crowd and hurtles toward the stage. The Edgerunners have once chance to knock it down (a DV 15 Check using an appropriate Skill) before it crashes into the stage and explodes like a Flashbang Grenade (SEE CP:R, PAGE 346).

Protocon, for all their original bluster, freezes no matter what happens to the drone and the disruption to the show effectively ends the concert with an untimely fizzle. Refer to the Night City Plaza Crowd's mood to determine whether the crowd panics and what type of obstacle they become.

The Edgerunners are now tasked with handling the situation. The Rockerboys take the Crew's lead and issue no instructions—but can and will perform simple tasks to help. The Crew also has access to bodyguards they can deploy to get themselves and Protocon to safety.

If the Crew manages to catch the hooded figure, either directly or with the help of the crowd, **GO TO DEV (RED KNIGHT IN THE PARK)**. If the hooded figure gets away, **GO TO DEV (THE SILVER CARD)**.

## DEV (RED KNIGHT IN THE PARK)

Either via direct action or with the help of the crowd, the Crew catches up with the hooded figure before they can escape from Night City Plaza. During the initial scuffle, the hood falls back to reveal a red helmet that covers the wearer's face. Finally, the Edgerunners come face to face with their enemy.

As soon as it becomes clear a fight's in the offing, the crowd backs away to form a 20 m/yd wide circle around Red Knight and the Crew. Just before Initiative, Red Knight injects themselves with a pair of hypos containing Black Lack and Synthcoke (SEE CP:R PAGES 357 & 358). Then the battle begins.

Since they're surrounded by a sea of people, using firearms proves dangerous. Any missed Ranged Attack hits a bystander instead. The minute someone in the crowd takes a bullet, panic sets in and the circle of bystanders shouting "Fight! Fight!" devolves into a riot.

The crowd swarms in every direction. Fighting Red Knight becomes impossible since it takes everything the Edgerunners have not to get trampled (each Round spent in the swell of rioting people requires succeeding at a DV 13 Endurance or Evasion Check to avoid 4d6 damage). Red Knight gets away but not before their hoodie rips off and ends up in an Edgerunner's hands. They find an unmarked, heavy silver card inside the pocket. **GO TO CLIFF (TWIST AND JOUST)**.

If the Crew manages to drop Red Knight to 5 or fewer Hit Points without starting a riot, the murderer stumbles and falls as the drug cocktail they've taken pushes them into an overdose. **GO TO CLIMAX (RED DEAD REVENGE)**.

## DEV (THE SILVER CARD)

While Red Knight got away, the Crew can still investigate the scene for clues. With a successful Perception Check (DV 13) the Crew finds an unmarked, heavy silver card next to the spot where Red Knight was standing during the concert. It appears it dropped out of the murderer's pocket when they fled.

If the Edgerunners don't think to search for clues or fail to find the card, someone else, either a member of the band or one of their bodyguards, gives it to the Crew.

**GO TO CLIFF (TWIST AND JOUST)**

## CLIFF (TWIST AND JOUST)

*It's time. Your adrenaline spikes and you snap to attention. You know this silver card's the key to finding Red Knight and dealing with them, once and for all. Now all you've got to do is answer the question: What the hell is this thing?*

Unmarked, the silver card holds few direct clues. A DV 13 Deduction or Education Check reveals it to be a keycard but little beyond that. Discovering its purpose requires some outside help.

The easiest way to learn about the keycard is to show it to the members of Protocon. Raegan immediately recognizes it as being an access card for Seral Grove, a secret memorial park built after the 4th Corporate War and used by Night City's elite to entomb their

# ONE RED NIGHT

dead away from potential desecration. She hasn't been there since she was a kid, but she's got family there and knows where it is.

Michael Deckard, if told about the card, informs the Crew about Seral Grove and gives them the location. He also emphasizes that he doesn't want this going to the press, so he expects Red Knight to vanish without any more high-profile activities.

If the Crew doesn't go to either Raegan or Deckard for information, allow them to explore other options. Fixers can call on contacts. Medias can dig up rumors. Edgerunners with a posh past rolled up as part of their Lifepath might know what it is right off the bat because they've got relatives entombed there.

Information might be located, buried on the Data Pool and found with a successful Library Search Check. If necessary, they can always buy the information from an NPC Fixer. Feel free to reward creativity here.

Once the Crew knows the location of Seral Grove, they can take a moment to rest up, reload, and do anything else they need. Don't give them too long, though.

If they take more than a day, Red Knight goes back on the cyberoffensive, and the press starts swarming the Crew again.

Getting to Seral Grove requires using the silver keycard to access a service tunnel located in New Westbrook, just outside the Executive Zone. From there, it's a short ride to the memorial park. The air smells damp, but clean and fresh—not near any sewers or trash dumps.

A short distance away, Seral Grove shines like a beacon of hope: It is a neon wonderland of cold, sterile beauty commemorating the dead in every leaf, stem, and twig. Even its river is nothing more than a data stream.

Theoretically, the site's defenses should recognize the Crew as guests, since they're carrying the silver keycard. But Red Knight's taken control of the NET Architecture **[SEE PAGE 167]**.

Once the Crew enters Seral Grove, they must avoid, dismantle, or disarm Seral Grove's defenses as they explore the area. A large air drone **[SEE PAGE 174]**

## 1. Entrance

## 2. Electrical Flooring

## 3. Stun Panel

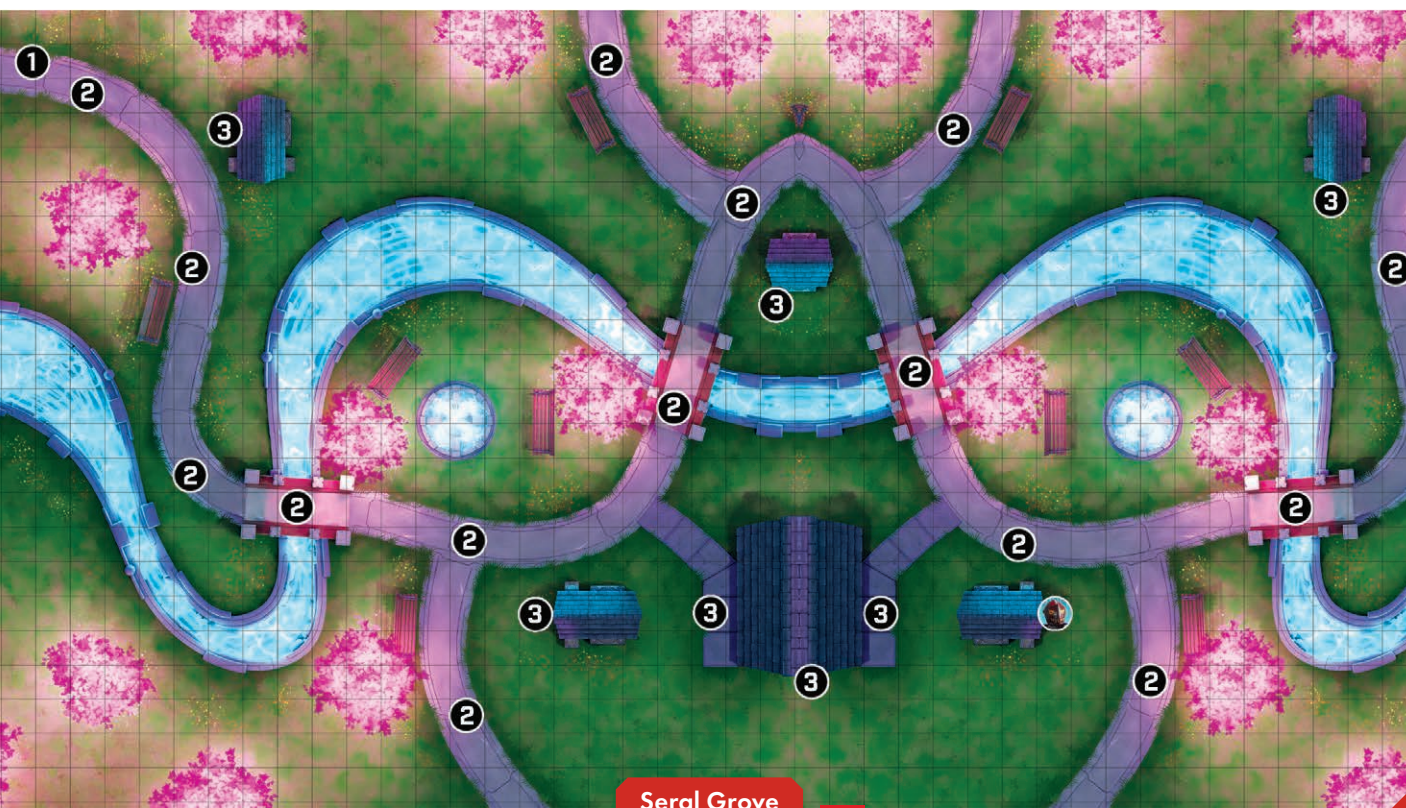

BY ZOMA RPG

patrols the grounds and rush over if any other defenses are triggered. Electrical Flooring (**SEE PAGE 174**) and Stun Panels (**SEE PAGE 174**) form the remainder of the defenses.

Red Knight's happy to let those defenses soften the Edgerunners up before the fight begins. Make the journey through the Grove as long or short as you need to fit the circumstances and you session. The memorial park can be much larger than the map provided (**SEE PAGE 162**).

As the Crew moves through Seral Grove and deals with the defenses, read them excerpts from Red Knight's Ramblings (**SEE PAGE 165**). These play from the speakers built into the various memorials and statues and represent Red Knight's descent into cyberpsychosis.

When the Crew reaches Red Knight's location, the Deckard family plot, they see the murderer standing dramatically in the middle of some sort of fog but clearly decked out in red armor, complete with a knight's helmet. Red Knight speaks to a hologram of Layla Deckard as if she were real. Their voice is obscured by a voice modulator built into the helmet.

*"I tried, Layla. I tried to avenge us both, but nothing I did went right! None of my plans worked the way they should have. The people who hurt us. They're still out there. Still living and laughing and ruining lives and sending their mercenaries to stop me. But I'll stop them. I'll stop them and then I'll finish the plan. We'll have our justice!"*

With that, Red Knight injects both airhypos, taking their full drug cocktail. Initiative should be rolled and the battle joined. The "fog" is actually an Air Swarm Drone Clouds, controlled by a Balron, which acts at the top of the Round. If the GM thinks Red Knight needs more help, they can add any number of automated pop-up turrets to the scene (**SEE PAGE 174**).

Red Night uses the environment to distract and unsettle the Crew. Red Knight prefers a personal, targeted approach, and torments them with holograms of people the Edgerunners have lost in **Bathed in Red** (**PAGE 127**) or during a previous mission. On their Turn, Red Knight may randomly trigger a disturbingly realistic hologram of one of those loved ones without taking an Action. Any affected Edgerunner must succeed at a DV 15 Concentration Check or take a -2 penalty to all Checks until Red Knight's next Turn.



BY HÉLIO FRAZÃO

The hologram of Layla watches the combat, passively, all the while. If parts of Red Knight's Ramblings remain unread, read one at the top of each Round.

If the Crew manages to drop Red Knight to 5 or fewer Hit Points, the murderer stumbles and falls as the drug cocktail they've taken pushes them into an overdose.

## GO TO CLIMAX (RED DEAD REVENGE)

## CLIMAX (RED DEAD REVENGE)

*This is it, choomba. The moment when you get to find out who's been killing people all around you while trying to set you and your Crew up to be the patsies. Vengeance. Can you feel that sharp pinch, choomba? The tip of that sweet sword, piercing your heart, begging you to fall down, down, down into that blood-gushing cesspool and ignore the angel on your shoulder? Will you do what Raegan wanted: Drag Red Knight out under the sun called truth for all the world to see? Or will you give in to your darkness and do Deckard's bidding: Throw Red Knight into the deepest hole possible and bury the past?*

# ONE RED NIGHT

The Crew has two decisions to make.

- First, they try can save Red Knight from the overdose with a DV 17 First Aid Check or a DV 15 Paramedic Check or Medical Tech Check—or they can let the murderer suffer and die. If they save Red Knight, the murderer slips into a coma and can't be awakened.
- More importantly, they must decide which they'd prefer to do: take the clues present in Seral Grove and share them with the world, or do what Michael Deckard wants and make it all go away.

If the Crew decides to share the info, **GO TO RESOLUTION (OUT IN THE LIGHT)**.

If the Crew would rather finish the job for Deckard, **GO TO RESOLUTION (BURIED PAST)**.



BY ERNANDA SOUZA

## RESOLUTION (OUT IN THE LIGHT)

Removing Red Knight's helmet shocks the Crew when they witness a face they've seen before: Roman Deckard, the "murder victim" from **Bathed in Red**.

In Seral Grove, not far from the Deckard family plot, they find a small camp where Red Knight had been squatting. Among the discarded Kibble wrappers and empty Black Lace vials is an audio recorder. The memory chip inside holds Red Knight's full audio diary, including the excerpts they've heard during their journey through Seral Grove (**SEE RED KNIGHT'S RAMBLINGS**).

If there's a Media in the party, they can break the story. Otherwise, they can hand over the info to a friendly media or, if needed, Protocon knows someone who can publish an exposé.

What happens to Red Knight (or their body) is up to the Crew. The most likely outcome is they hand Red Knight over to NCPD, who either takes the murderer into custody or to the morgue.

Obviously, if that happens, the Crew won't get paid by Michael Deckard and the access codes at Pleasant Valley Apartments will change, locking them out. They've also made an enemy of the Exec, though Michael Deckard can't immediately seek revenge since he's too busy being fired by Biotechnica for staining their reputation with his son's revelations.

On the other hand, they've made friends with Protocon, who are shocked to learn the truth about Red Knight's identity and motives. Once the dust has settled, the band invites the Crew out for an over-the-top victory party.

## RESOLUTION (BURIED PAST)

Removing Red Knight's helmet shocks the Crew when they witness a face they've seen before: Roman Deckard, the "murder victim" from **BATHED IN RED**.

In Seral Grove, not far from the Deckard family plot, they find a small camp where Red Knight had been squatting. Among the discarded Kibble wrappers and empty Black Lace vials is an audio recorder. The memory chip inside holds Red Knight's full audio diary,



*"The pain wouldn't go away, so Reggie slipped me some Black Lace to help. And it did. I know what I need to do now. My whole family's rotten. Me. Dad. Mom. Everyone. Everyone but Layla. She knew what was up. She was trying to get out. And they killed her for it. I think I had it right. Right tactics. Wrong targets. Red Knight's going back in action. Watch out Deckard family."*

...

*"First things first. I need to vanish. I know dad's got eyes on me but with the Black Lace and Boost, I've got a plan. First, I head to my favorite club. Delirium. Let word slip I'm looking for someone to help me. Red Knight's targeting me. Throwing out some confusion, you see? If I'm Red Knight, why would Red Knight be after me? Screw with Dad's head. Then I go to stage two. There's some kids I've seen around Delirium. Street scum, living underground. One of them looks sort of like Dillon so they're fair game. I'll grab a few, drag them to this ripperdoc I know. Reggie got me a bunch of Megabite, upgraded special by a Tech he knows. It'll make these kids do whatever I want. After that, I find some homeless scum. Clean him up. Ripperdoc can biosculpt him to look like me. Make one of the kids do the deed, throw in some confusion with a ransomware attack and... hee-hee... Roman's dead. Long live Red Knight."*

...

*"Red Knight's camping out at Seral Grove. Talking to Layla. Waiting for it all to go down. Red Knight loves talking to Layla. She makes him feel better. She tells him it wasn't his fault. Tells him Lilah Deckard's looking into him. Tells him Lilah's first."*

...

*"Where did they come from? Who are they? Why are they messing with Red Knight? But... Red Knight can use them. Right? Red Knight can use them to punish Lilah Deckard."*

...

*"It didn't go like Red Knight planned. Things happened. Red Knight needs to think. Visited Reggie. Killed him. Took his stash. That'll help me think. Layla's getting repetitive. She needs more data so she can tell different stories. Have different conversations. Maybe Raegan has some. Red Knight will call her."*

*"Raegan didn't understand. She didn't help. Wouldn't give Red Knight the videos of Layla. No. That's not right. Red Knight understands now. She's in on it. She's with the Deckards! She is on the list, now."*

...

*"Found Michael Deckard. He's out in the open again. And communicating with the Crew who messed with Red Knight's plans for Lilah Deckard. There's too much going on at once. This Crew. Raegan. She's announced a concert. Going to play a new song. Special for the Red Knight. Got to be there. Can't touch Michael Deckard. Not yet. He's last. Need to punish someone, though. Maybe cousin Benjie. He's on campus. An easy target. I've got just the drones for the job. Post the footage. Leak the Crew's names. Make their life hell. Then I'll go to the concert. And then? Then I'll make Michael pay."*

## MORE ABOUT SERAL GROVE

Seral Grove is a futuristic cemetery located somewhere underneath Night City. It is a neon, inorganic wonder where metal and holography replace nature. Originally designed as an art installation by ultra-rich Rockerboys to commemorate those they lost, it has been slowly commandeered by the wealthy and elite as a vault: a place to hide their dead loved ones away from the sticky fingers of scavengers and the lurid eyes of the poor.

In addition to bodies, Seral Grove holds memories. Pictures and videos get stored on locked servers placed with each body. Anyone with access can visit and watch holographic memories play out, reminding them of what they've lost. The top tier package even constructs artificial personalities, much like those on Agents, to approximate the dead. These artificial personalities can't hold an in-depth conversation but can tell you a story about grandma's sweet sixteen party based on archived video footage stored on the server... all in her own voice.

Getting into Seral Grove isn't cheap. Reserving a space starts at 10,000eb—and the price only goes up from there.

## NET ARCHITECTURES

### ▶ PROTOCON'S NET ARCHITECTURE

**Demons Installed: None**

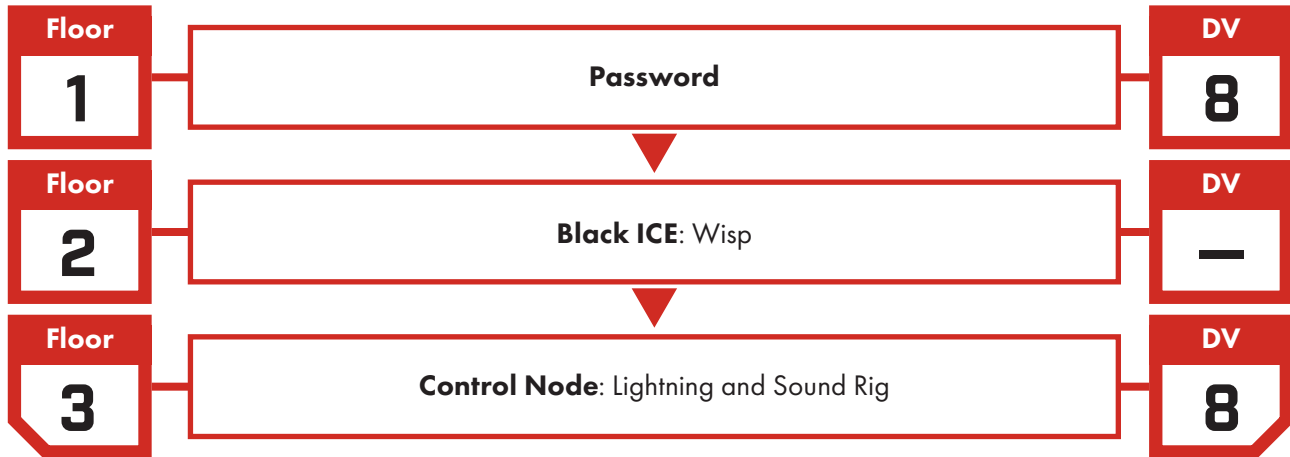

### ▶ SERAL GROVE'S SECURITY

**Demons Installed: Balron (tasked to drones)**

**REZ 30 • Interface 7 • NET Actions 4 • Combat Number 14**

Can perform any NET Action a Netrunner is capable of.

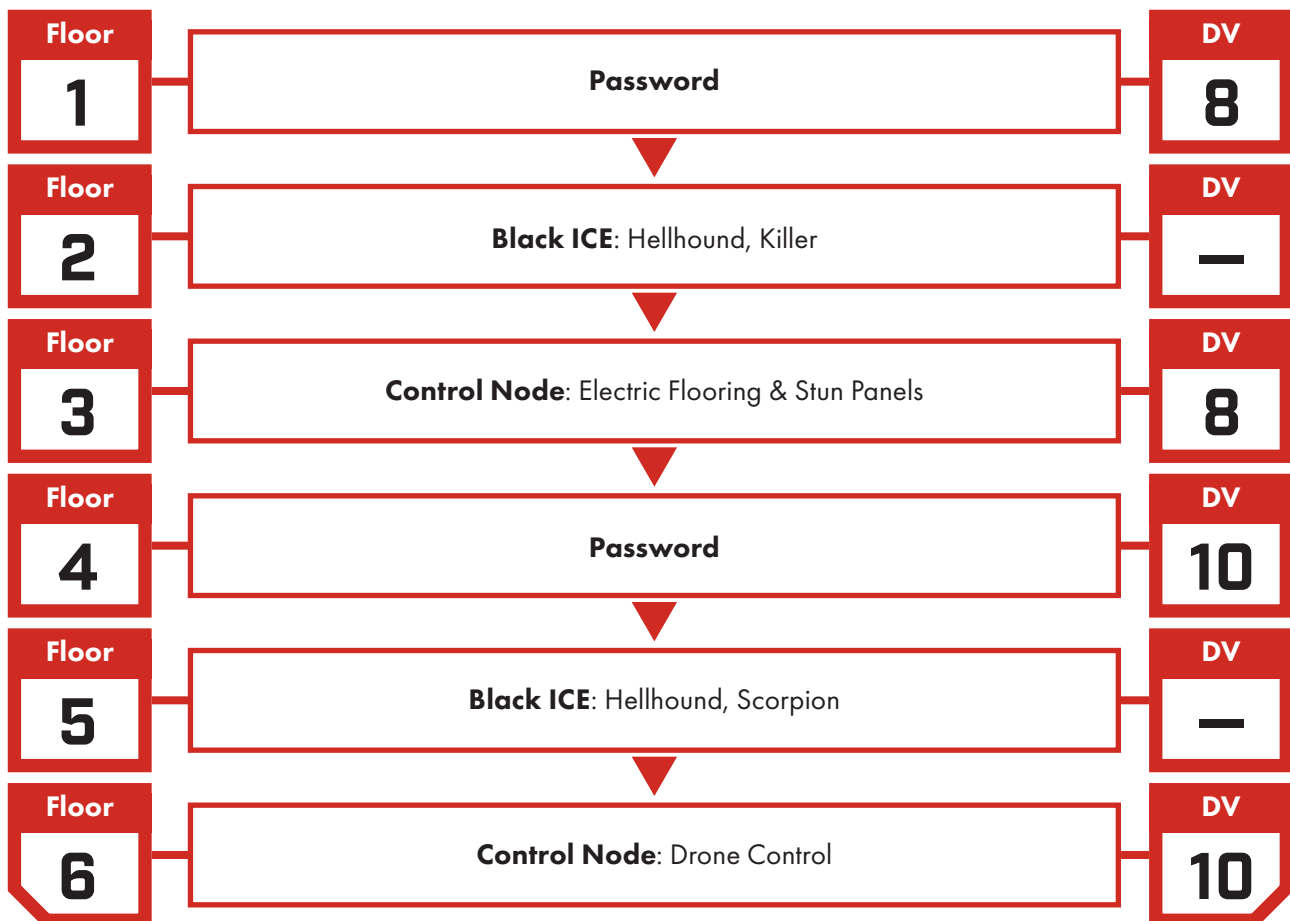

# ONE RED NIGHT

## NPC STAT BLOCKS

For more information on important NPCs **SEE APPENDIX B: BIOGRAPHIES.**

SEE PAGE 190 FOR BIOGRAPHY

<b>NAME</b>	RAEGAN "PRO" HALLEY (REP 5)			<b>SERIOUSLY WOUNDED</b>	20	<b>HP</b>	40
<b>ROLE</b>	ROCKERBOY: CHARISMATIC IMPACT 7			<b>DEATH SAVE</b>	4		
<b>STATS</b>							
<b>INT</b>	4	<b>REF</b>	6	<b>DEX</b>	7	<b>TECH</b>	7
		<b>COOL</b>	7	<b>WILL</b>	8	<b>MOVE</b>	7
		<b>BODY</b>	4	<b>EMP</b>	6		
<b>WEAPONS</b>				<b>ARMOR</b>			
EX QUALITY LIGHT MELEE WEAPON (IN SHOE)				ROF2	1d6	KEVLAR® (BODY)	
EX QUALITY LIGHT MELEE WEAPON (IN SHOE)				ROF2	1d6	NONE	
<b>SKILL BASES</b>							
Athletics 9 • Brawling 13 • Composition 10 • Concentration 10 • Conversation 10 • Education 7 • Evasion 13 • First Aid 11 Handgun 12 • Human Perception 12 • Language (English) 8 • Language (Streetslang) 10 • Local Expert (Exec Zone) 8 Melee Weapon 13 • Perception 7 • Personal Grooming 17 • Persuasion 13 • Play Instrument (Harp) 11 Play Instrument (Singing) 13 • Stealth 9 • Streetwise 13 • Wardrobe & Style 17							
<b>GEAR</b>							
Agent • Harp • Handcuffs (disguised as bangles) • Pocket Amp • Portable Microphone • Radio Scanner/Music Player							
<b>CYBERWARE</b>							
AudioVox • Biomonitor • Chemskin • Contraceptive Implant • Light Tattoo x3 • Shift Tacts • Skinwatch • Techhair							

SEE PAGE 192 FOR BIOGRAPHY

<b>NAME</b>	SHANNA "TO" DOOLE (REP 4)			<b>SERIOUSLY WOUNDED</b>	20	<b>HP</b>	40
<b>ROLE</b>	ROCKERBOY: CHARISMATIC IMPACT 5			<b>DEATH SAVE</b>	4		
<b>STATS</b>							
<b>INT</b>	6	<b>REF</b>	6	<b>DEX</b>	6	<b>TECH</b>	5
		<b>COOL</b>	7	<b>WILL</b>	8	<b>MOVE</b>	5
		<b>BODY</b>	4	<b>EMP</b>	6		
<b>WEAPONS</b>				<b>ARMOR</b>			
EXCELLENT QUALITY LIGHT MELEE WEAPON				ROF2	1d6	KEVLAR® (BODY)	
NONE				—	—	NONE	
<b>SKILL BASES</b>							
Accounting 12 • Athletics 7 • Basic Tech 7 • Brawling 7 • Bureaucracy 10 • Business 10 • Concentration 10 • Conversation 12 Deduction 10 • Education 10 • Electronics/Security Tech 7 • Evasion 9 • First Aid 8 • Human Perception 8 • Language (French) 8 Language (Streetslang) 12 • Local Expert (Upper Marina) 8 • Melee Weapon 10 • Perception 8 • Personal Grooming 10 Persuasion 13 • Play Instrument (Drums) 13 • Play Instrument (Singing) 8 • Streetwise 8, • Wardrobe and Style 10							
<b>GEAR</b>							
Agent • Drum Synthesizer • Drumsticks • Memory Chips x10 • Radio Scanner/Music Player							
<b>CYBERWARE</b>							
Contraceptive Implant • Cyberaudio Suite w/ Audio Recorder • Neural Link w/ Chipware Socket							

<b>NAME</b>	KINNETH "CON" DE LÉON (REP 4)		<b>SERIOUSLY WOUNDED</b>	18	<b>HP</b>	35
<b>ROLE</b>	ROCKERBOY: CHARISMATIC IMPACT 4		<b>DEATH SAVE</b>	5		

**STATS**

INT 4 REF 6 DEX 6 TECH 7 COOL 7 WILL 4 MOVE 7 BODY 5 EMP 5

<b>WEAPONS</b>			<b>ARMOR</b>	
EX QUALITY HEAVY MELEE WEAPON (IN GUITAR)	ROF2	3d6	KEVLAR® (BODY)	SP 7
NONE	—	—	NONE	—

**SKILL BASES**

Athletics 9 • Basic Tech 10 • Brawling 9 • Concentration 6 • Conversation 12 • Education 8 • Electronics/Security Tech 8  
 Evasion 9 • First Aid 9 • Human Perception 12 • Language (Spanish) 10 • Language (Streetslang) 10  
 Local Expert (Upper Marina) 9 • Melee Weapon 8 • Perception 8 • Personal Grooming 11 • Persuasion 13  
 Play Instrument (Guitar) 12 • Play Instrument (Sing) 10 • Streetwise 8 • Wardrobe and Style 13

**GEAR**

Agent • Electric Guitar • Memory Chips x10 • Portable Amp • Radio Scanner/Music Player

**CYBERWARE**

Chemskin • Contraceptive Implant • Enhanced Antibodies • Light Tattoo x3 • Shift Tacs • Toxin Binders

<b>NAME</b>	RED KNIGHT (REP 5)		<b>SERIOUSLY WOUNDED</b>	23	<b>HP</b>	45
<b>ROLE</b>	NETRUNNER: INTERFACE 6 SOLO: COMBAT AWARENESS 2		<b>DEATH SAVE</b>	8		

**STATS**

INT 8 REF 8 DEX 8 TECH 6 COOL 3 WILL 6 MOVE 7 BODY 8 EMP -2

<b>WEAPONS</b>			<b>ARMOR</b>	
VERY HEAVY MELEE WEAPON (CLAYMORE)	ROF1	4d6	BODYWEIGHT SUIT (HEAD)	SP 11
NONE	—	—	BODYWEIGHT SUIT (BODY)	SP 11

**SKILL BASES**

Athletics 10 • Basic Tech 12 • Brawling 10 • Conceal/Reveal Object 10 • Concentration 8 • Conversation 0  
 Cryptography 12 • Deduction 12 • Education 12 • Electronic/Security Tech 12 • Evasion 12 • First Aid 8 • Forgery 12  
 Human Perception 0 • Language (English) 12 • Language (Streetslang) 10 • Library Search 14  
 Local Expert (Seral Grove) 10 • Melee Weapon 14 Perception 10 • Persuasion 5 • Pick Lock 12 • Stealth 12 • Tactics 10

**GEAR**

Airhypos x2 (loaded w/ Black Lace and Synthcok) • Agent • Excellent Quality Cyberdeck • Silver Keycard  
**Cyberdeck Hardware:** DNA Lock • Insulated Wiring (in Bodyweight Suit) • Range Upgrade  
**Cyberdeck Programs:** Armor • Eraser • Hellbolt • Speedy Gonzalvez • Superglue • Sword

**CYBERWARE**

Grafted Muscle and Bone Lace • Neural Link w/ Interface Plugs, Kerenzikov



*Travel back to the days  
of your great-grandparent's  
youth and experience  
entertainment the way it  
was meant to be, with  
Popcorn Kibble.*

*All the flavor and crunch  
of summer plus 12 Creotic Amino  
acids to boost your immune system  
and fill your body with energy.*

*So real you'll see stars.*



Do not eat with Smash. Do not eat after midnight. Do not eat while soaked in CHOOH. Do not mix with Kiwi Kibble. You have been warned.

LA LUNE BLEUE

*If you don't already know, you don't deserve our cuisine.*



# APPENDIX A: MOOKS AND DEFENSES

<b>NAME</b> BODYGUARD (REP 0)	<b>SERIOUSLY WOUNDED</b> 18	<b>HP</b> 35
<b>ROLE</b> NONE	<b>DEATH SAVE</b> 6	

**STATS**

INT 3 REF 6 DEX 5 TECH 2 COOL 4 WILL 4 MOVE 4 BODY 6 EMP 3

<b>WEAPONS</b>			<b>ARMOR</b>	
POOR QUALITY SHOTGUN	ROF1	5d6	KEVLAR® (HEAD)	SP 7
VERY HEAVY PISTOL	ROF1	4d6	KEVLAR® (BODY)	SP 7

**SKILL BASES**

Athletics 9 • Brawling 11 • Concentration 6 • Conversation 5 • Drive Land Vehicle 10 • Education 5 • Endurance 9 • Evasion 7 • First Aid 4 • Handgun 10 • Human Perception 5 • Interrogation 6 • Language (Native) 5 • Language (Streetslang) 5 • Local Expert (Your Home) 5 • Perception 9 • Persuasion 6 • Resist Torture/Drugs 8 • Shoulder Arms 10 • Stealth 7

**GEAR**

Slug Ammo x25 • Very Heavy Pistol Ammo x25 • Radio Communicator

**CYBERWARE**

None

<b>NAME</b> BOOSTERGANGER (REP 0)	<b>SERIOUSLY WOUNDED</b> 10	<b>HP</b> 20
<b>ROLE</b> NONE	<b>DEATH SAVE</b> 2	

**STATS**

INT 2 REF 6 DEX 5 TECH 2 COOL 4 WILL 2 MOVE 4 BODY 2 EMP 3

<b>WEAPONS</b>			<b>ARMOR</b>	
POOR QUALITY VERY HEAVY PISTOL	ROF1	4d6	LEATHER (HEAD)	SP 4
RIPPERS	ROF2	2d6	LEATHER (BODY)	SP 4

**SKILL BASES**

Athletics 9 • Brawling 9 • Conceal/Reveal Object 4 • Concentration 4 • Conversation 5 • Drive Land Vehicle 10 • Education 4 • Endurance 6 • Evasion 7 • First Aid 4 • Handgun 12 • Human Perception 5 • Interrogation 6 • Language (Native) 4 • Language (Streetslang) 4 • Local Expert (Your Home) 4 • Melee Weapon 11 • Perception 6 • Persuasion 6 • Resist Torture/Drugs 4 • Stealth 7

**GEAR**

Very Heavy Pistol Ammo x30 • Disposable Cellphone

**CYBERWARE**

Rippers • Techhair

# APPENDIX A: MOOKS AND DEFENSES

<b>NAME</b>	<b>ROAD GANGER</b> (REP 0)		<b>SERIOUSLY WOUNDED</b>	<b>13</b>	<b>HP</b>	<b>25</b>
<b>ROLE</b>	<b>NONE</b>		<b>DEATH SAVE</b>	<b>3</b>		

**STATS**

**INT** 4 **REF** 6 **DEX** 4 **TECH** 4 **COOL** 3 **WILL** 3 **MOVE** 3 **BODY** 3 **EMP** 3

WEAPONS			ARMOR	
VERY HEAVY PISTOL	ROF1	4d6	LEATHER (HEAD)	SP 4
CROSSBOW	ROF1	4d6	LEATHER (BODY)	SP 4
LIGHT MELEE WEAPON	ROF2	1d6		

**SKILL BASES**

Archery 10 • Athletics 10 • Brawling 6 • Concentration 5 • Conversation 6 • Drive Land Vehicle 12 • Education 6  
Endurance 5 • Evasion 6 • First Aid 6 • Handgun 10 • Human Perception 5 • Land Vehicle Tech 10  
Language (Native) 6 • Language (Streetlangu) 6 • Local Expert (Your Home) 6 • Melee Weapon 8 • Perception 6  
Persuasion 5 • Stealth 8 • Tracking 8 • Wilderness Survival 8

**GEAR**

Very Heavy Pistol Ammo x20 • Arrow Ammo x20 • Rope • Flashlight

**CYBERWARE**

Neural Link w/ Interface Plugs

<b>NAME</b>	<b>SECURITY OPERATIVE</b> (REP 0)		<b>SERIOUSLY WOUNDED</b>	<b>15</b>	<b>HP</b>	<b>30</b>
<b>ROLE</b>	<b>NONE</b>		<b>DEATH SAVE</b>	<b>5</b>		

**STATS**

**INT** 3 **REF** 7 **DEX** 4 **TECH** 2 **COOL** 2 **WILL** 3 **MOVE** 3 **BODY** 5 **EMP** 3

WEAPONS			ARMOR	
POOR QUALITY ASSAULT RIFLE	ROF1	5d6	KEVLAR® (HEAD)	SP 7
VERY HEAVY PISTOL	ROF1	4d6	KEVLAR® (BODY)	SP 7
MEDIUM MELEE WEAPON	ROF2	2d6		

**SKILL BASES**

Athletics 8 • Autofire 10 • Brawling 6 • Concentration 7 • Conversation 5 • Education 5 • Evasion 6 • First Aid 4  
Handgun 10 • Human Perception 5 • Interrogation 6 • Language (Native) 5 • Language (Streetlangu) 5  
Local Expert (Your Home) 5 • Melee Weapon 6 • Perception 5 • Persuasion 4 • Resist Torture/Drugs 5  
Shoulder Arms 10 • Stealth 6

**GEAR**

Rifle Ammo x40 • Very Heavy Pistol Ammo x20 • Radio Communicator

**CYBERWARE**

None

# APPENDIX A: MOOKS AND DEFENSES

## ▶ DEFENSES USED IN *TALES OF THE RED*

Type	Loadout/Effects	Data
<b>Air Swarm Drone Cloud</b> <i>(Active Defense)</i>	<ul style="list-style-type: none"> <li>Very Heavy Melee Weapon</li> </ul>	8 MOVE • 15HP Perimeter of Defended Area DV 17 Electronics/Security Tech, 5min to counter.
<b>Ground Drone</b> <i>(Active Defense)</i>	2 of the following: <ul style="list-style-type: none"> <li>Very Heavy Pistol w/ Armor Piercing Ammo</li> <li>SMG w/ Basic Ammo</li> <li>Observation Camera</li> </ul>	4 MOVE • 30HP Perimeter of Defended Area DV 21 Electronics/Security Tech, 5min to counter.
<b>Mini Air Drone</b> <i>(Active Defense)</i>	1 of the following: <ul style="list-style-type: none"> <li>Very Heavy Pistol w/ Armor Piercing Ammo</li> <li>Dartgun w/ Poison Arrows</li> <li>Observation Camera</li> </ul>	6 MOVE • 15HP Perimeter of Defended Area DV 17 Electronics/Security Tech, 5min to counter.
<b>Large Air Drone</b> <i>(Active Defense)</i>	2 of the following: <ul style="list-style-type: none"> <li>Very Heavy Pistol w/ Armor Piercing Ammo</li> <li>Dartgun w/ Poison Arrows</li> <li>Observation Camera</li> </ul>	6 MOVE • 20HP Perimeter of Defended Area DV 21 Electronics/Security Tech, 5min to counter.
<b>Automated Turret</b> <i>(Emplaced Defense)</i>	1 of the following: <ul style="list-style-type: none"> <li>Assault Rifle w/ Basic Ammo</li> <li>Flamethrower w/ Incendiary Shotgun Shells</li> <li>Dartgun w/ Poison Arrows</li> <li>Very Heavy Pistol w/ Armor Piercing Ammo</li> <li>Heavy SMG w/ Basic Ammo</li> </ul>	Combat Number 14 • 25HP Perimeter of Defended Area DV 17 Electronics/Security Tech, 5min to counter.
<b>Electrical Flooring</b> <i>(Environmental Defense)</i>	Grid wired to section of flooring. Delivers 6d6 damage to target's body, reduced by armor (does not ablate). Target is shocked at the end of each Turn spent on the flooring.	20HP Perception DV 17 to spot DV 13 Electronics/Security Tech, 1min to counter.
<b>Laser Grid</b> <i>(Environmental Defense)</i>	Grid of lasers projected from ceiling and walls. Touching a laser is like being hit in the body with a Very Heavy Melee Weapon. If perceived, the grid can be avoided with a DV 17 Contortionist Check, touching on a failure.	Perception DV 17 to spot DV 17 Electronics/Security Tech, 5min to counter.
<b>Stun Panels</b> <i>(Environmental Defense)</i>	Delivers stunning blast of light and sound. Anyone within 10 m/yds must make DV 15 Resist/Torture Drugs Check or suffer from Damaged Eye and Damaged Ear Critical Injuries for 1 minute. They don't suffer the Critical Injury's bonus damage.	5HP Perception DV 17 to spot DV 13 Electronics/Security Tech, 1min to counter.



## APPENDIX B

### LOCATIONS

In this appendix you'll find a map of Night City with locations important to the Missions in this book pinned, followed by a short description of each. In general, the travel time between locations in the Missions isn't critical and can be handwaved but if you want to give a basic sense to your Players, employ the following guideline. Using the map on the next page, add 10 minutes of travel time for each  $\frac{1}{2}$  inch (1.27cm) between two locations if the Crew is journeying by ground vehicle. Double this if they're traveling by public transport and triple it if they're going without transport. These are general time estimates and don't reflect distance traveled so much as the difficulties of navigating Night City.

# APPENDIX B: LOCATIONS

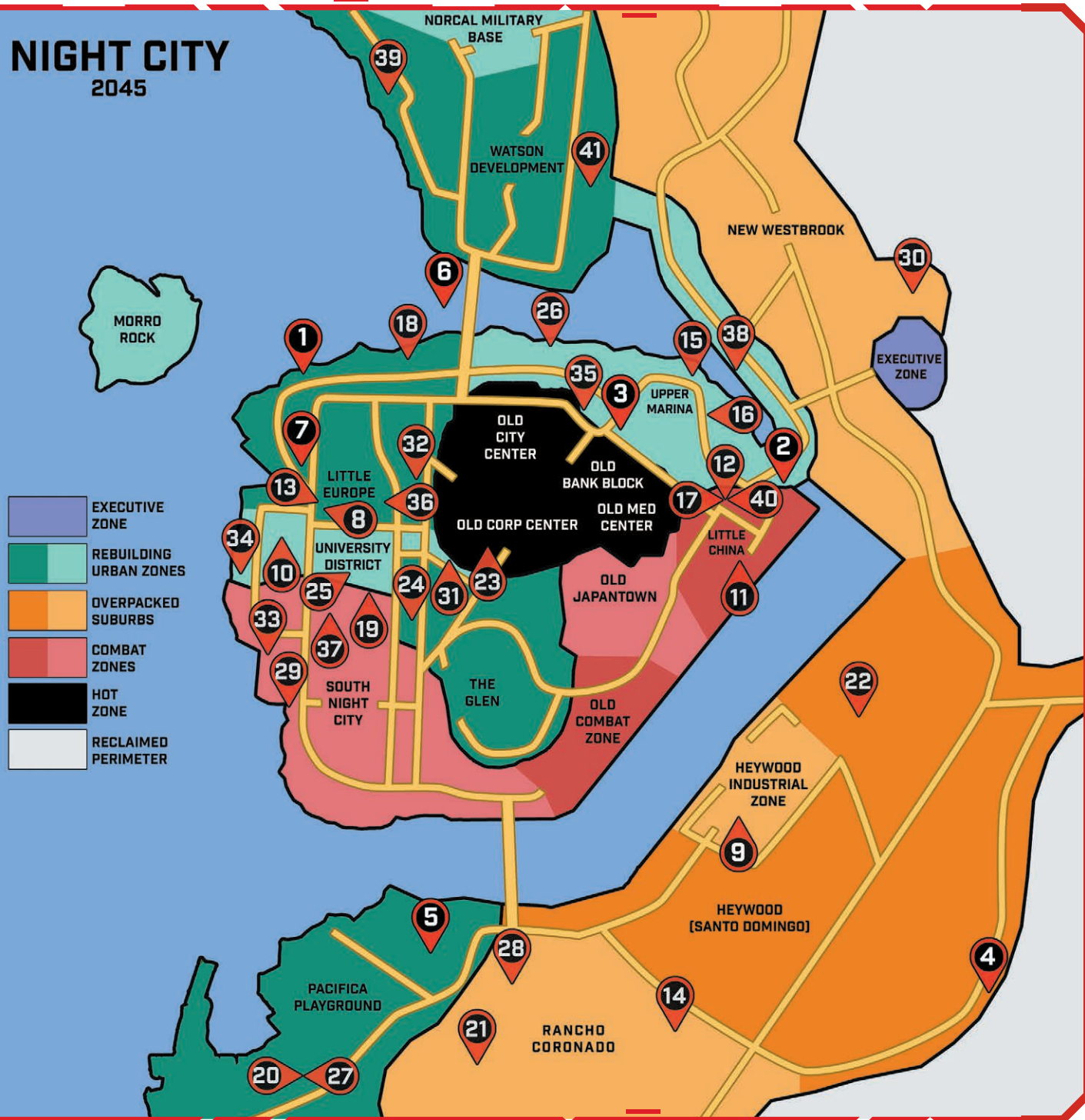

NIGHT CITY CIRCA 2045

## TALES OF THE RED LOCATIONS

1. **Abandoned Warehouse:** An unused shipping warehouse near the docks in Little Europe. It is empty and contains nothing of value. *Appears in Bathed in Red.*
2. **Anonymous-Looking Warehouse:** A nondescript warehouse, usually rented for short periods by various interests. *Appears in A Bucket of Popcorn-Flavored Kibble.*

## APPENDIX B: LOCATIONS

- The Afterlife:** The premiere Solo bar in Night City, built in the remains of an old morgue on the outskirts of the Hot Zone, and run by the legendary Solo, Rogue. Every Solo in the city dreams of getting a drink at the Afterlife named after them—even if it only happens post-mortem. *Mentioned in Agents of Desire. Appears in Staying Vigilant.*
- Aldecaldo Camp:** A large, multi-cultural encampment at the edge of the city where the Aldecaldo Nomads run an expansive trade and transport network, hiring themselves out to guide people across the badlands and transport goods just about anywhere. *Appears in Staying Vigilant.*
- Bits'n'Bolts:** An average shake and bake business that specializes in quick repairs for the working class choomba and local salvage. The clientele is mostly construction workers that need spot repairs on smaller pieces of equipment and cyberware. *Appears in Reaping the Reaper.*
- Broken NCART Tunnels:** Ancient, broken tunnels beneath the bay. Used by NCART before the 4th Corporate War. *Appears in Drummer and the Whale.*
- Darrel Marchant's House:** An old brick building that survived the 4th Corporate War, and has recently been renovated with contemporary materials, while preserving the historical façade. It is covered with what appears to be ivy at first sight, but a closer examination reveals each of the ivy leaves to be a synthetic bioengineered solar panel. *Appears in A Bucket of Popcorn-Flavored Kibble.*
- Delirium:** Delirium is an alternative lifestyle club scene where every type of goth/punk fits in. It is a three-story kickass entertainment scene that ranges from cute (think lolita fashion) to in your face BDSM fashion. Glitter goths, Victorian, industrial, cyber-you name it, this scene has something for club attendees with those interests thanks to cheap, proprietary virtuality goggles known as Dee Vees. The first enviro of the night is free but switching virtual environments costs 20eb (Everyday). *Appears in Bathed in Red. Mentioned on One Red Night.*
- D.V. Rambling Rose:** A rusted old hulk of a ship. The Rambling Rose are in drydock when the 4th Corporate War halted all work. Since then, squatters have filled in the gaps with concrete and compost and converted it, and the shipping containers inside, into a multiuse, make-shift building. It is currently home to Fixie's Couriers. *Appears in Haven't Got a Stitch to Wear.*
- Food Truck Plaza:** A relatively safe outdoor plaza just outside the main Night City University cafeteria. A number of different food trucks can be found here during the day. *Appears in Night at the Opera.*
- The Forlorn Hope:** A small, exclusive Solo bar that caters primarily to veterans from the SouthAm and 4th Corporate Wars, serving as a home away from home to many of the City's most dangerous retired Solos. Run by John and Marianne Freeman. *Appears in Reaping the Reaper and Agents of Desire.*
- Guǎngbō Tower:** Before the Fourth Corporate War, Guǎngbō Tower was home to KLIA 99.2, a radio station specializing in news and radio dramas. Last year, the Little China Redevelopment Association purchased the building and began renovating it. Tenants include Virtex's Virtuality Venue, a medical clinic, and the Ling Po Public Library. *Appears in Reaping the Reaper.*
- Home:** A transient community run by street rats that doubles as an occasional Night Market run with the help of a few different, friendly Fixers. The location isn't important: Home moves when needed. Home is usually located underground and no resident is over the age of 21. *Appears in Bathed in Red.*
- Jack 'N' the Green:** A Reclaimer company located in Rancho Coronado. Cheech, aka The Wizard, runs this group. *Appears in A Bucket of Popcorn-Flavored Kibble.*
- Kodai Khan's Conapt:** An expensive conapt in an exclusive building. Before the 4th Corporate War, the building belonged to an upscale law firm and the classic stylings remain. *Appears in Agents of Desire.*

## APPENDIX B: LOCATIONS

16. **La Lune Bleue:** A rather exclusive restaurant, said to have “the finest French cuisine” on the West Coast. *Appears in Agents of Desire.*
17. **Ling Po Public Library:** The Ling Po Public Library was financed and named for Mister David Ling Po (SEE CP:R PAGE 304) and represents his investment in the future of this area. It offers many services to the community but can only be accessed by residents of Little China. It is located on the tenth floor of Guǎngbō Tower. *Appears in Reaping the Reaper.*
18. **Lotus LeMarch’s Place:** A tiny conapt on the waterfront in Little Europe. *Appears in Agents of Desire.*
19. **MindNutz Lover:** A new braindance club located in South Night City. Despite having only been open for a few weeks, it has recently closed for renovations. *Appears in Reaping the Reaper.*
20. **Mister Rice Guy:** An automated, always open sushi joint in the Pacifica Playground known for its black rice roll. It offers a wide selection of foods, ranging from kibble flavored with a South Asian flare to actual, real fish. Best known for their mascot, a virtual personality known as Hime Cat, who tells fortunes for customers. *Appears in One Red Night and Reaping the Reaper.*
21. **Movie Lot:** A temporary movie lot set up by the Senait sisters to facilitate the making of their newest film, Parisian Hostess. *Appears in A Bucket of Popcorn-Flavored Kibble.*
22. **Nana Meow’s Nursery:** A family-run business in lower Heywood that specializes in selling aquaponic equipment and seeds. *Appears in A Bucket of Popcorn-Flavored Kibble.*
23. **Network 54 Building:** What remains of the once-proud Night City headquarters of Network 54, the world’s largest media network. *Appears in Reaping the Reaper.*
24. **Night City Plaza:** A safe, Corporate-built park located in The Glen. Various artists and groups hold concerts and theatrical performances there on most weekends. *Appears in One Red Night.*
25. **Night City Symphony Hall:** Once a beautiful and gothic concert venue, the Hall fell into disuse following the 4th Corporate War. It is now the headquarters of the Philharmonic Vampyres, who treat it as both a performance space and a club. *Appears in Night at the Opera.*
26. **Nondescript Dock:** One dock out of many on the Upper Marina waterfront. *Appears in Drummer and the Whale.*
27. **Pleasant Valley Apartments:** Eight-stories tall, this apartment complex in Pacific Playground was built to cater to neo-luddites but soon earned a reputation as a discreet place for Execs to rent for a short period of time in order to hole up, hold secret meetings, or engage in affairs. *Appears in One Red Night.*
28. **RC Night Market:** The RC Night Market isn’t a single venture but dozens of them, each put together by various Fixers working in cooperation with one another. The one thing they have in common is their location — they all take place in Minimallism, a once trendy shopping plaza located in the heart of Rancho Coronado. The multiple Night Markets setting up, often concurrently, in this one location provides the illusion of an ongoing bazaar instead of dozens of individual operations. *Appears in Haven’t Got a Stitch to Wear.*
29. **Rusty’s Dive Shack:** A cheap swill shack on the waterfront. The front of the bar is the recovered bridge and loading doors of an old IHAG container sub. The owners carved the rest out of a stack of containers welded together. *Appears in Drummer and the Whale.*

## APPENDIX B: LOCATIONS

30. **Seral Grove:** A futuristic cemetery located somewhere underneath Night City. It is a neon, inorganic wonder where metal and holography replace nature. Originally designed as an art installation by ultra-rich Rockerboys to commemorate those they lost, it has been slowly commandeered by the wealthy and elite as a vault: a place to hide their dead loved ones away from the sticky fingers of scavvers and the lurid eyes of the poor. In addition to bodies, Seral Grove holds memories. Pictures and videos get stored on locked servers placed with each body. Anyone with access can visit and watch holographic memories play out, reminding them of what they've lost. The top tier package even constructs artificial personalities, much like those on Agents, to approximate the dead. These artificial personalities can't hold an in depth conversation but can tell you a story about grandma's sweet sixteen party based on archived video footage stored on the server... all in her own voice. *Appears in One Red Night.*
31. **Server Farm:** A abandoned building in the University District used by the High Heist Crew as a server farm. *Appears in Agents of Desire.*
32. **Short Circuit:** A favorite haunt of Techs and Netrunners, it's not uncommon to find patrons of this bar hauling wrecked tech in from the Hot Zone to tinker with in the booths—Zhirafa drones at the door keep people from hauling in anything too dangerous. Run by Brain and his husband, 3-Piece. *Appears in Drummer and the Whale.*
33. **South Night City Waterfront:** A long stretch of land on the edge of the city. It is a mix of warehouses, flophouses, and smash-houses. None of them are safe. Few of them are legit. The roads are bad. The few legitimate businesses that operate here directly cater to 'gangsters, criminals, and addicts. The rest are usually straight-up illegal. *Appears in Drummer and the Whale.*
34. **Stems & Seeds:** A guerrilla gardening collective in the University District. *Appears in A Bucket of Popcorn-Flavored Kibble.*
35. **Tent City:** One of many different shanty-towns in Night City. This particular one is on the edge of the Hot Zone and the downtrodden residents are often accosted by Scavvers and other gangsters. A few abandoned warehouses line the outskirts, including one used by Hardhat and her crew. *Appears in Staying Vigilant.*
36. **Torrell and Chiang's:** A tailor shop geared towards the very finest end of bespoke tailoring. Their house specialty is discreet armor and stain-proof coatings to make sure the upwardly mobile Exec doesn't ruin their clothing in the occasional hostile takeover attempt. This is their business headquarters but they often run stalls at high-end Night Markets and Midnight Markets. *Appears in Haven't Got a Stitch to Wear.*
37. **Union Chapel Building:** A church built during the initial glory days of Night City, the Union Chapel Building has since been abandoned and fallen into disrepair. *Appears in Night at the Opera.*
38. **Upper Marina Docks:** A perfect spot for loading and unloading cargo. There's a heavy Nomad presence. A mixture of ships dock here between rusted out old hulks leftover from before the 4th Corporate War. *Appears in Reaping the Reaper.*
39. **Vargtimmen:** Heathen and neo-pagan "meadery". Wily proprietor Freki (she/her) owns this faux Viking hall in Watson. *Appears in A Bucket of Popcorn-Flavored Kibble.*
40. **Virtex's Virtuality Venue:** A virtuality arcade located on the top floor of Guǎngbō Tower. It offers a mixture of new and classic games but is currently closed for renovations. *Appears in Reaping the Reaper.*
41. **Yum Seng:** A hole-in-the-wall karaoke bar in the Watson Development which caters to the large Asian population moving into the district from Little China and Old Japan Town. *Appears in Drummer and the Whale.*



SØ VO



BY NEIL BRANQUINHO



# APPENDIX C

## BIOGRAPHIES

While stat blocks for certain NPCs are included at the end of each Mission, this appendix shares biographical information for every named Character in **Tales of the RED**. They're listed in alphabetical order by first name or Handle. Most of these NPCs are making their first appearance in the Cyberpunk universe in this book and we wanted to put their bios all in one place in case you want to use them again, seed them in other Missions, or even link them to an Edgerunner's Lifepath.

# APPENDIX C: BIOGRAPHIES



**Aisha "Ai" Tiang**

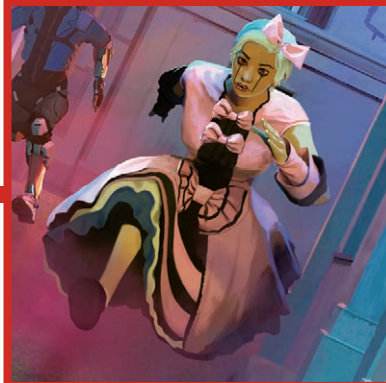

**Asher**



**Barbara Dahl**

## TALES OF THE RED BIOGRAPHIES

**512** (he/him): A member of Lightning Logistics. 512 is a professional and believes strongly in his code: you do the job you're signed up for, you take orders, and you keep fighting until there's no other choice. He has a past with John Doe. *Appears in Haven't Got a Stitch to Wear.* **STAT BLOCK ON PAGE 89.**

**Aaron Tyler Walsh** (he/him): Commander Walsh is a die-hard patriot who signed on with Militech after a long career in the US Military. He was born and raised on the east coast and grew up in a very pro-government family with a long tradition of military service. Commander Walsh likens the current state of the United States to the American Civil War of the 1860s, referring to Night City, Texas, and the Pacifica Confederation as secessionists and insisting that they will be brought back into the Union. *Appears in Drummer and the Whale.* **STAT BLOCK ON PAGE 69.**

**Aisha "Ai" Tiang** (she/her): Aisha Tiang was a fairly low level employee at 4overTechnologies, a mid-level firm specializing in customer support databases and information recovery. Ai and Kodai met about twenty years ago and became a regular item, but their relationship took a turn, when Kodai had Ai Soukilled during a cyberpsychotic break. The "new" Aisha is almost indistinguishable from her real self besides being a virtual construct in Kodai's agent. At least as far as Kodai's concerned. *Appears in Agents of Desire.*

**Anya** (she/her): Out of hundreds of possible candidates to pick as his personal assistant (and personal covert operative), Michael Deckard picked Anya. Despite the cyberware she's sporting, Anya dreams of living an all-natural life in a world where Biotechnica's scientific advances make cyberware, and many other modern technological advances, a thing of the past. She hasn't fallen for her boss but she's willing to pretend she has in order to achieve her dreams and climb the corporate ladder. *Appears in Bathed in Red and One Red Night.*

**Asher** (she/they): A member of the Lost Kids and resident of Home, a collective of street orphans. Asher is short, has white hair, and is in a relationship with Flaxx. They've befriended Zero Gees, a bartender at Delirium, and refers to her as "Mom". Asher knows how to tug at the heartstrings to earn favors and the occasional meal. They're great at social interactions, but panic easily. *Appears in Bathed in Red.* **STAT BLOCK ON PAGE 146.**

**Ashley** (they/them): A teen living in Night City. Ashley is the loudest and boldest member of the Simwives, an Etan Sim fan club. *Appears in A Bucket of Popcorn-Flavored Kibble.*

**Auntie Ivy** (she/her): A tough, flannel-wearing middle-aged woman with a literal green thumb. A member of the Dirty Hippies and an expert in hydroponics. *Appears in Haven't Got a Stitch to Wear.*

**Barbara Dahl** (she/her): Evening news anchor for Network 54 in Night City. She's well known for her ability to smile through any crisis. *Appears in A Night at the Opera.*



## APPENDIX C: BIOGRAPHIES



**Biodrones**



**Bullhorn**



**Cookie**



**Dan Renzer**

**Biodrones:** Once the Reaper discovered the security flaw in Mediaware Braingen Internal Agents, it began hollowing out people's brains and transforming them into biological drones. Base level drones can perform simple tasks and will continue to follow the last order given to them by the Reaper or a Biodrone+ as best they can. They cannot make decisions for themselves or adapt to new situations. Biodrones+ retain some basic decision-making capabilities and can change plans so long as it advances whatever plans the Reaper gives it. Biodrones+ can issue orders to Biodrones using vocalized commands. The Biodrone DJ is all that remains of the last Netrunner to "befriend" the Reaper and is directly controlled by Reaper Prime via a hardwired connection. *Appear in Reaping the Reaper.* **STAT BLOCKS ON PAGES 109 AND 110.**

**Boom-Boom** (he/him): A member of Lightning Logistics. Boom-Boom's a capable all-around Tech but has a special love for explosives. *Appears in Haven't Got a Stitch to Wear.* **STAT BLOCK ON PAGE 90.**

**Buck** (he/him): Tall, flannel-clad, and as Midwestern as they come. Buck runs the practical effects workshop for the Senait Sisters' production company. *Appears in A Bucket of Popcorn-Flavored Kibble.*

**Bullhorn** (she/her): A member of Hardhat's crew. Bullhorn used to work Corporate fulfillment until she lost her job due to a clerical error in the system. She's had to start all over again as an independent operator. *Appears in Staying Vigilant.* **STAT BLOCK ON PAGE 123.**

**Cheech** (he/him): Also know as the Wizard. Runs Jack 'N' the Green, a Reclaimer company operating out of Rancho Coronado. *Appears in A Bucket of Popcorn-Flavored Kibble.*

**The Chicken Lady** (she/her): A messy-haired older woman wearing a chicken hat. She sells live poultry and the various supplies needed to keep them alive. *Appears in Haven't Got a Stitch to Wear.*

**ConEx** (he/him): Also known as Harry Depuy. Leader of Lightning Logistics. He used to work for Continental Express, a small shipping company but broke off to form Lightning Logistics, a crew he designed to take over the operation of Fixie's Couriers. Usually smarmy and well put together, he's convinced he can run Fixie's operation better than she can. He's also her ex. *Appears in Haven't Got a Stitch to Wear.* **STAT BLOCK ON PAGE 88.**

**Cookie** (she/her): Head of on-lot catering for the Senait Sisters' production company. It is her job to keep the crew fed and the talent happy by meeting what are often unreasonable dietary demands. *Appears in A Bucket of Popcorn-Flavored Kibble.*

**Dan Renzer** (he/him): Dan Renzer grew up in Night City and saw how things were playing out for the worst. He wanted to make a difference, so when he was old enough he joined NCPD and worked his way up from beat cop to detective. Once there, he learned the truth: anyone with money could buy a badge. After he refused to play ball he had a mysterious accident involving a "cyberpsycho". Renzer barely survived. Disillusioned but still wanting to do some good, he joined Netwatch. Unfortunately, because he's new to the agency and because he's not a Netrunner, he's on the bottom run of Netwatch's hierarchical ladder. *Appears in Reaping the Reaper.* **STAT BLOCK ON PAGE 109.**

## APPENDIX C: BIOGRAPHIES



**Darrel Marchant**



**Dave**



**Drummer**

**Darrel Marchant** (he/him): Darrel Marchant is a true child of the Time of Red, born to Reclaimer parents on the outskirts of Night City. His parents managed to provide him and his siblings with a safe, stable upbringing, sound, wholesome meals, and even a decent education to boot. His parents and the commune they lived in was located on a major Nomad route, and they exchanged food, goods, and shelter for protection, transport, and luxuries unavailable on the farmstead. A whirlwind romance with a young Nomad man led to Darrel leaving the commune for Night City with the blessings of his family. That relationship did not last, but his relationship with Nomad families did, which led to frequent lucrative work as a guard on sensitive shipments. Darrel's perceptive nature and quick reflexes soon built him a reputation for guarding the most precious of cargo: VIPs. *Appears in A Bucket of Popcorn-Flavored Kibble.* **STAT BLOCK ON PAGE 50.**

**Dave** (he/him): A member of the Lost Kids and resident of Home, a collective of street orphans. Dave serves as the group medic and carries a Medium Pistol he's never fired. He doesn't say much but doesn't quite fit in either. He usually appears calm but suffers from depression and PTSD because of a bullying incident he perpetrated in his past. *Appears in Bathed in Red.* **STAT BLOCK ON PAGE 147.**

**Delphine** (she/her): Neo-hippie street psychic who works stalls in various Night Markets. *Appears in Haven't Got a Stitch to Wear.*

**Dillon Murphy** (he/him): Night City University student, professional protester, and boyfriend of Layla Deckard. Dillon was cyberbullied by Layla's brother, Roman, in a scheme to force a break-up between the two. Unfortunately, the scheme worked too well and a paranoid Dillon killed Layla and then himself in a murder/suicide plot. *Mentioned in Bathed in Red and One Red Night.*

**Doc Stoic** (he/him): Doc doesn't talk much about his past. Or anything at all, really. He used to be with Trauma Team. Now he's not with Trauma Team. He's set up shop at the Forlorn Hope and does good business repairing the various injuries, cybernetic or biological, sustained by the bar's clientele. *Appears in Reaping the Reaper.*

**Drummer** (he/him): Patient, curious, and inventive. A small, soft-spoken man, Drummer sits at the edge of parties, just watching the flow of conversation. That's his professional style as well: when it comes to real-time and historical pattern analysis, Drummer is in a class of his own. He works for EON Data Consultants on jobs for firms like Ziggurat, Network 54, and Zhirafa, who come to him for trends in their exadata flows: big, boring jobs. He's the last guy you'd expect to hire a squad of Edgerunners, especially since he doesn't have a good grasp on life outside his corporate bubble. Most of what he knows comes from vid-streams and news broadcasts. Almost dangerously naïve, Drummer would be a liability on any field mission. Hell, he'd be a dangerous guy to go to an Oasis with—no ability to read a room, and he sticks out like a sore thumb. *Appears in Drummer and the Whale.* **STAT BLOCK ON PAGE 68.**





# APPENDIX C: BIOGRAPHIES



**Flaxx**



**The Impaler**



**John Doe**

**Flaxx** (they/them): A member of the Lost Kids and resident of Home, a collective of street orphans. Flaxx is tall, waif-thin, and has a shaved head. Hot-headed but loyal, Flaxx doesn't trust strangers easily and is afraid of being swept into "the system." They often run away from their problems and is in a relationship with Asher. Like many street orphans, they suffer from malnutrition. *Appears in Bathed in Red.* **STAT BLOCK ON PAGE 147.**

**Freki** (she/her): Proprietor of Vargitmmen, a faux Viking hall and "meadery" located in Watson. *Appears in A Bucket of Popcorn-Flavored Kibble.*

**Grace Steel** (she/her): Grace used to be military. She used to be a Back Bay Brawler. She's hung it all up to pursue her true love: music. Her particular brand of chromatic metal is fast, shrill, and powerful. Recently, Grace won a contest and secured a position as leader of the Forlorn Hope's house band. *Appears in Reaping the Reaper.*

**George Edward Rhinemeyer** (he/him): A Rocklin Augmentics Executive Engineer. His daughter, Lucy, attends school at Night City University. *Mentioned in A Night at the Opera.*

**Hardhat** (she/her): A Solo who just broke her way into the Afterlife. She's hungry for reputation and status but shrewd enough to realize it takes time and effort. She leads a small crew that operates out of the Upper Marina, near the Hot Zone. *Appears in Staying Vigilant.* **STAT BLOCK ON PAGE 123.**

**The Impaler** (he/him): A member of the Lost Kids and a resident of Home, a collective of street orphans. The Impaler grew up on The Street and eventually found refuge in Home. He feels a sense of responsibility for the others and trains them in self defense. With his 21st birthday coming up soon, he worries both about how he'll survive without the support of Home and how the kids of Home will survive without his help. *Appears in Bathed in Red.* **STAT BLOCK ON PAGE 146.**

**Jane Gatsby** (she/her): Jane Gatsby, real name Laura Vogt, is a struggling college student at Night City University. She joined up with the High Class Heist Crew to scratch together enough money to pay for her school supplies and continue her education but she isn't willing to die for the gang. *Appears in Agents of Desire.* **STAT BLOCK ON PAGE 36.**

**Jaya Almazan** (she/her): A covert agent, working for Arasaka in regions outside of Japan. Her current assignment has her undertaking missions in the United States. *Appears in Drummer and the Whale.*

**Jezz Stiles** (she/her): The daughter of Veronica Stiles, Jezz worked as a data analyst for Ziggurat. Jezz died during an impromptu Digital Divas concert when she ran into oncoming traffic. She had a taste for gothic stylings and an association with the Sinful Adams, a poser gang. *Mentioned in Reaping the Reaper.*

**John Doe** (he/him): A dapper operative working in Night City. He sprung up on the Night City scene a few years ago and has a reputation as a consummate professional, specializing in covert operations. Rumor has it he's an ex-spook. John really loves his suits and plays Elfines Online. *Appears in Haven't Got a Stitch to Wear.* **STAT BLOCK ON PAGE 90.**



## APPENDIX C: BIOGRAPHIES



**Kinneth "Con" de León**



**Kodai Khan**



**Lilah Deckard**

**Juri McCullough** (they/them): Lives in Night City. Local producer and representative of Addiswood film directors the Senait Sisters. *Mentioned in A Bucket of Popcorn-Flavored Kibble.*

**Kenneth Dahl** (he/him): Husband of Network 54 news anchor Barbara Dahl. He died in 2044. *Appears in A Night at the Opera.*

**Kinneth "Con" de León** (he/him): Protocon's guitarist. He acts unaffected and cocky but that's all a mask to hide the truth: he's struggling with fame and afraid he doesn't measure up to his bandmates. Of all the members of Protocon, his feelings about music are the most pure. *Appears in One Red Night. STAT BLOCK ON PAGE 169.*

**Kodai Khan** (he/him): Kodai is a deeply troubled Ziggurat Executive, living with a complex case of Cyberpsychosis. Over a decade ago the combination of extensive cyber enhancement, crushing workplace stress, and his own feelings of inadequacy stemming from his girlfriends' reluctance to officially get married, pushed him over the edge. Kodai lost control and in a fit of paranoia, blackmailed an old associate into soulkilling his girlfriend and placing her engram in his agent so she would never leave him. After the procedure, Kodai was shocked back to his senses but spurred on by unimaginable grief and guilt, fabricated an alternate reality where he and his girlfriend Ai are constantly on the verge of getting married, living in pre-wedded bliss. Kodai has been living in this alternate reality for years and shows no signs of snapping out of it. *Appears in Agents of Desire. STAT BLOCK ON PAGE 36.*

**Layla Deckard** (she/her): A Night City University student and oldest child of the Deckard family. Layla served as the spokesmodel for Cactus Water, the homeopathic drink sold by a company run by her parents. Polyamorous, Layla dated both Raegan Halley and Dillon Murphy while in school. Pushed over the edge by a plot perpetrated by her father and brother, Dillon killed Layla and then herself. She is memorialized in Seral Grove. *Mentioned in Bathed in Red and One Red Night.*

**Lazar** (they/them): A costume technician working for the Senait Sisters' production company. They like to keep up on the latest gossip. *Appears in A Bucket of Popcorn-Flavored Kibble.*

**Lilah Deckard** (she/her): Lilah Deckard always wanted an idyllic suburban family to shield her from worrying about riots and Nomads and all the other Night City News headlines that gave her insomnia. And she thought she found it when she graduated from Night City University with a degree in business management and married a young, brilliant junior Petrochem Exec named Michael Deckard. Everything seemed to be on track. The couple had two beautiful children and Petrochem put Michael in charge of Cactus Water, a secret spin-off company selling "homeopathic" water. Then it all went to hell. Michael vanished. Petrochem pushed Lilah into the Cactus Water CEO seat and she learned the horrible truth: Cactus Water wasn't homeopathic at all. It was just unfiltered and dangerous tap water. Now, things are worse. Red Knight's come after her family, using manipulation and coercion to kill both her children. Though she's amassed a fortune and power via her position as CEO, Lilah's never felt more powerless. *Appears in Bathed in Red. Mentioned in One Red Night. STAT BLOCK ON PAGE 148.*

# APPENDIX C: BIOGRAPHIES

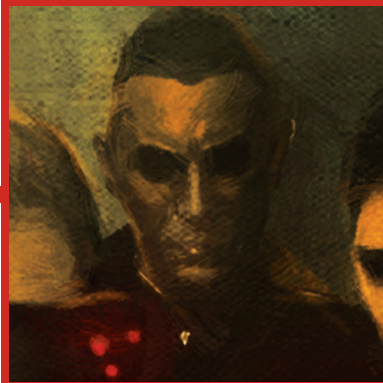

Lord Ruthven



The Clown



The Monk



Luzia Tanzia

**Lily** (she/her): Lead gardener of Stems & Seeds, a guerrilla gardening collective in the University District. Appears in *A Bucket of Popcorn-Flavored Kibble*.

**Lord Ruthven** (he/him): A former psychology professor at Night City University. After the 4th Corporate War, Ruthven used his fortune and resources to fund the Philharmonic Vampyres, helping them survive the Time of the Red. By 2045, his dark side and cybernetic experimentation has grown to the point where he has gone cyberpsycho and become obsessed with Network 54 anchorperson Barbara Dahl. A few months ago he broke away from the Philharmonic Vampyres and somehow recruited a small contingent of Bozos and Inquisitors to work for him. He truly believes he is a vampire lord. Appears in *A Night at the Opera*. **STAT BLOCK ON PAGE 17.**

**Lord Ruthven's Lieutenants:** Two individuals, one a former Bozo (the Clown) and one a former Inquisitor (the Monk), who were somehow convinced by Ruthven to not only leave their gangs and work for him but to bring along a contingent of their own followers to serve as Ruthven's muscle. Appear in *A Night at the Opera*. **STAT BLOCKS ON PAGES 15 AND 16.**

**Lotus LeMarch** (he/him): Lotus LeMarch is a highly skilled tech who used to work for Arasaka before the 4th Corporate War. He specialized in inventing cyberware and was highly sought after when Arasaka fell. Unfortunately, his time with Arasaka also earned him many enemies and he's decided that a quiet life suits him better than trying to get back into the corporate ring. He enjoys his life of isolation, doing jobs for friends of friends and people with particularly interesting ideas or problems. Appears in *Agents of Desire*.

**Lowball** (he/him): A mid-level Fixer who does work for various Corporate clients, including REO Meatwagon, Raven Microcybernetics, and Continental Brands. He likes to brag his handle comes from always getting the best deal when he's shopping but the truth is, he excels at squeezing money out of his clients and paying as little of it as possible to his crews. Appears in *Staying Vigilant*.

**Lucy Rhinemeyer** (she/her): A 19 year old student at Night City University. The latest victim in a string of kidnappings in the area. Appears in *A Night at the Opera*.

**Luzia Tanzia** (she/her): An up-and-comer following the 4th Corporate War, Luiza originally worked as a freelance merc. Initially, Veronica Stiles hired Luiza for missions but, over time, the two became friends, and eventually, Luiza joined Veronica and her husband in the bedroom. It all fell apart after Veronica's husband died. Luiza had been on the mission and the guilt she felt in surviving overwhelmed her. She vanished from the radar, eventually turning to synthcoke to dull the pain. Luiza probably would have died in the Combat Zone, alone and strung out, if Veronica hadn't found Luiza, helped her through recovery, and got her a job with Militech. As far as Lieutenant Tanzia is concerned, she may be employed by Militech but her loyalty lies entirely with Major Stiles. Appears in *Reaping the Reaper*. **STAT BLOCK ON PAGE 108.**

**Mael Cartaret** (she/her): A movie star of some fame and leading lady in the latest Senait Sisters production, Parisian Hostess. Behind the scenes, she's known for her refined palette and her preferences for real, all-organic foods as part of her beauty routine. Appears in *A Bucket of Popcorn-Flavored Kibble*.



## APPENDIX C: BIOGRAPHIES

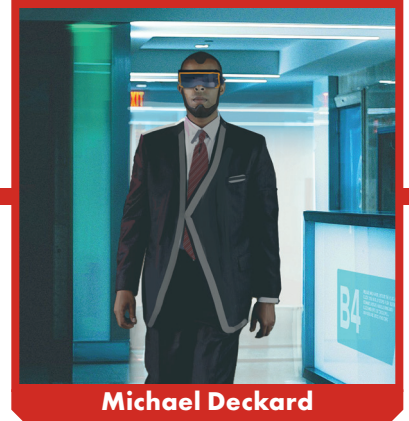

**Magnus Haggard** (he/him): Delirium’s manager. Haggard lives in a small, studio apartment on the third floor of the club. Red-haired and freckled, the club boss sports a mohawk and several piercings, dresses in gray, pinstriped suits, and prefers vintage punk to “that earsplitting crap.” Haggard doesn’t say much and the staff refers to him as a “cranky old grump.” He’s addicted to Smash and has been known to drink himself unconscious. *Appears in Bathed in Red. Mentioned in One Red Night.*

**Markus “Malarkey” Bornholm** (he/him): Malarkey is a local Night City “journalist” of the most trashy tabloid variety. Sensation, sleaze, and almost-libel are his best friends, as he follows people around recording their worst behavior in order to manufacture a viral trend. Malarkey makes enough off his sensationalist vidjournalism that he can afford a crew of muscle to keep him largely unbruised during his missions to expose others to the searing eye of the Night City Data Pool. *Appears in A Bucket of Popcorn-Flavored Kibble. STAT BLOCK ON PAGE 50.*

**Marianne Freeman** (she/her): Marianne’s been serving as co-owner and chief bartender of the Forlorn Hope for decades. She likes to joke she was there when it opened and it’ll close over her dead body. Known for her wicked sense of humor, Marianne watches out for those Edgerunners she’s formed an attachment to, thinking of them as “her kids”. Having gone through transition in the rougher, early days of biosculpting, she’s particularly (if sarcastically) motherly to her transgender patrons. *Appears in Reaping the Reaper. Mentioned in Agents of Desire.*

**The Master** (he/him): One of the leaders of the Philharmonic Vampyres and an aspiring director who wishes to breathe new life into the gothic classics. Everything he does is stagehand overly dramatic. *Appears in A Night at the Opera.*

**Maurice the Maitre’d** (he/him): Maitre’d at La Lune Bleue. You know that snobby guy you knew in school—the one who came from money and made sure everyone around him knew it? Maurice is that guy. There’s something that makes you want to rip that fakey little pencil mustache off his smug face. Oh yeah; it’s his warm and friendly personality. *Appears in Agents of Desire.*

**Michael Deckard** (he/him): Michael’s always been ambitious and he worked from the beginning to build the perfect life. Pretty wife. Two pretty kids. Top job. Everything was great. Then it all began falling apart. A project he was leading failed and Petrochem was looking for a scapegoat. As an act of desperation, he pitched an idea to convince the bosses to look elsewhere: take ordinary tap water from wherever in Night City, bottle it in something fancy, label it with homeopathic buzzwords, and sell it for a high price. Management loved the idea and he was off the hook. In fact, management loved it so much they put him in charge of the new company they secretly owned, Cactus Water Incorporated. Michael hired his photogenic daughter, Layla, as the company’s spokesperson and sales skyrocketed. Then things started falling apart again. Layla got a new granola-loving boyfriend, Dillon Murphy, and was starting to question “the Corporate monolith controlling modern life”. Michael needed to do something about this before she went off the rails and damaged the brand, so he tasked his son, Roman, with the job of taking care of the problem. Only, Roman did his work too well. Dillon killed Layla, then himself. Michael knew he needed to vanish. He contacted Biotechnica and negotiated to a deal to defect onto their payroll based on his success with Cactus Water. He even got a new mistress out of the deal. *Mentioned in Bathed in Red. Appears in One Red Night.*

# APPENDIX C: BIOGRAPHIES



**Ms. Mynah**



**Nat**



**Raegan "Pro" Halley**

**Ms. Mynah** (she/her): A Fixer of Indian descent who specializes in labor and logistics. She works heavily with Fixie's Couriers and often operates out of an office in the RC Night Market. *Appears in Haven't Got a Stitch to Wear.*

**Mr. Suzuki** (he/him): Owner of a mobile bodega specializing in Japanese-American foodstuffs. His niece, Mio, is a budding Rockerboy with a band made up of adorable middle-schoolers. *Appears in Haven't Got a Stitch to Wear.*

**Myrtle** (she/her): Owner of Myrtle's Mini-Livestock, a strange shop that sells bugs for protein and other purposes. She's a tiny, blue-haired old lady with a PhD in entomology. *Appears in Haven't Got a Stitch to Wear.*

**Nana Meow** (she/her): Owner of Nana Meow's Nursery, a family-run business in lower Heywood specializing in aquaponic equipment and seeds. *Appears in A Bucket of Popcorn-Flavored Kibble.*

**Nat** (she/her): A skilled warrior and member of the Jodes Nomad Nation. Nat used to work with her Pack to transport food along the west coast, from Night City down to South America. On a recent run to Night City, her Pack was ambushed by a crew under the employ of Continental Brands. Only Nat survived and now she's looking for payback. *Appears in Staying Vigilant.* **STAT BLOCK ON PAGE 125.**

**Oliver Riddle** (he/him): A slender, purple-haired man in a nice, boring gray suit. The personal assistant of movie star Etan Sim. *Appears in A Bucket of Popcorn-Flavored Kibble.*

**Patchz** (he/him): A rough-hewn tech working for Bits'n'Bolts. He occasionally does contract work for Faisal. *Appears in Reaping the Reaper.*

**Professor Huntver** (he/him): A psychology professor at Night City University. He has not attended class or kept office hours for some time. For more information about the professor, see Lord Ruthven (**PAGE 188**). *Appears in A Night at the Opera.*

**Raegan "Pro" Halley** (she/her): Daddy's little princess always knew she wanted to be a Rockerboy when she grew up in the Executive Zone. 'Course, she wanted to be a lot of things. Concert harpist. Personal stylist. Actress. It was hard for her to settle on "professional singer" even though Daddy's money, influence, and connections did help. Only, Kandra never asked what Daddy did for a living, never wondered where her Mommy went, or why she suddenly had a bodyguard at age 15. Kandra didn't ask a lot of things, but somehow everything seemed to work out. That's why she's not overly curious about the details—a mysterious, powerful guardian always seems to have her back whenever she gets into trouble. When she went pro, Kandra changed her name to Raegan Halley. Fabricating a new identity, she formed Protocon three years ago—ancient history according to some—and hasn't looked back. Someday she'll ask herself why Daddy insisted she get biosculpting and install all that fashionware to change her appearance before performing in public, but for now Raegan's living the dream with her best bandmates and a string of lovers. She fell in love with Layla Deckard but broke up with her because she felt Dillon Murphy was bad news. Since Layla's death, Raegan has grown increasingly obsessed with finding the truth behind it all. *Appears in One Red Night.* **STAT BLOCK ON PAGE 168.**



## APPENDIX C: BIOGRAPHIES



**The Reaper**



**Red Knight**



**Rogue Amendiares**

**The Reaper:** Beyond being an AI, no one knows the Reaper's origins. It might be the twisted remains of a Soulkilled Netrunner. It might be a R.A.B.I.D. exhibiting strange personality quirks. It might be something else entirely. Nor does anyone understand its motivations. The Reaper seems to only desire control, death, and chaos. After escaping the Old NET, the Reaper began a new life moving from Netrunner to Netrunner, learning, growing, and ending each partnership in organic death. Now, after discovering the backdoor exploit in the Mediaware Braingen, it has switched tactics from indirect control via whispers and promises to direct control of brain-burned Biodrones via digital signal. To facilitate its work, the Reaper can create lesser copies of itself. The weaker variant, ReaperB, is sent on low priority missions while the more capable variant, ReaperA, runs major operations. The original Reaper, Reaper Prime, remains at the brandance club MindNutz Love, where it coordinates and schemes. *Appears in Reaping the Reaper.* **STAT BLOCKS ON PAGE 107.**

**Red Knight** (he/him): A bored rich kid with a love of pranks and party drugs, Roman Deckard had a posh life right up until his dad asked him to get rid of his sister Layla's boyfriend, Dillon Murphy. His efforts took a bad turn and both the boyfriend and Layla ended up dead. From there Roman went on a downward spiral into Cyberpsychosis as he used Black Lace to dull the pain and adopted the identity of Red Knight full time. His goal: to punish the entire Deckard family for the death of Layla. *Appears in Bathed in Red and One Red Night.* **STAT BLOCK ON PAGE 169 .**

**Reggie** (he/him): A Fixer and drug dealer working in the University District. He supplied Roman Deckard with various drugs as well as Megabyte packages that "fell off the truck". *Mentioned in One Red Night.*

**Richard** (he/him): Owner of an outlet stall known as Richard's Reminders. He sells clearance items from Vendits. *Appears in Haven't Got a Stitch to Wear.*

**Roman Deckard** (he/him): The youngest child of Cactus Water founder Michael Deckard and current CEO Lilah Deckard. He was a student at Night City University but dropped out after the death of his older sister, Layla. Before his murder, he spent several days hanging out at Delirium, looking for a Netrunner to help him with a problem—he was being harassed by Red Knight, the same mysterious figure who drove his sister's boyfriend to kill both himself and her. **SEE RED KNIGHT** for more information. *Appears in Bathed in Red and One Red Night.*

**Rogue Amendiares** (she/her): She was one of the best of the second generation of solos, known for running with top ranks like Morgan Blackhand and Santiago Aldecaldo. But a recent car crash tore her up badly; so badly that even cyberware couldn't fix all the internal damage. Now she's parlaying her Solo cred to start a new career as a Fixer and the owner of the Afterlife. *Appears in Agents of Desire and Staying Vigilant.*

**Rustle** (he/him): A newbie Edgerunner without reputation to his name. He's just enough of a force to boss around a few other toughs around into something resembling a crew. *Appears in A Bucket of Popcorn-Flavored Kibble.*

## APPENDIX C: BIOGRAPHIES



Shanna "To" Doole



Shears

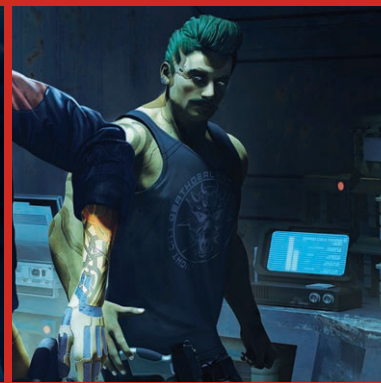

Sledge



Spanner

**Sall3 Smite** (they/she): Earlier this year, Militech ran a tech recruitment operation disguised as a contest. There were advertisements, celebrity endorsements, and prizes. The purpose was to scoop up young technicians from lower-class backgrounds who could be brainwashed and trained by Militech as disposable field engineers. One of the winners was Sall3 Smite, a smartass, pink-haired pixie from Pacifica Playground. Luckily for the young engineer, Major Stiles realized Sall3's potential (and a resemblance to her deceased daughter) and scooped them up before they could be processed through Militech's braingrinders. This is their first field assignment for the Major and Sall3's determined to prove their worth. *Appears in Reaping the Reaper.* **STAT BLOCK ON PAGE 108.**

**Samuelson** (he/him): A locksmith who sells security to his customers. He doesn't ask many questions but he also takes safety seriously. He won't go to a lock if he thinks there's a good chance he'll be shot. *Appears in Haven't Got a Stitch to Wear.*

**Sandy Sheldon** (she/her): A potter and owner of Coronado Ceramics, an independent ceramics studio. *Appears in Haven't Got a Stitch to Wear.*

**Shanna "To" Doole** (she/her): The drummer for Protocon and the band's de facto manager. She's shrewd, knows how to negotiate, and believes in the band as a family. At the end of the day, she knows Raegan will leap without thinking and Kinnith will just go along with anything, so it is up to her to keep the band safe. *Appears in One Red Night.* **STAT BLOCK ON PAGE 168.**

**Shears** (they/them): A tailor at Torrell and Chiang's. A slight, well-dressed person of East Asian ancestry with dyed blue-green hair. Known for their habit of keeping their employees and contractors extremely well fed. *Appears in Haven't Got a Stitch to Wear.*

**Sledge** (he/him): A member of Hardhat's crew. Not long ago, Sledge worked construction during the day and the amateur boxing ring at night. Hardhat saw him fight and thought he had potential, so she recruited him as the newest member of her crew. He's still learning the ropes. *Appears in Staying Vigilant.* **STAT BLOCK ON PAGE 124.**

**Spanner** (he/him): A member of Hardhat's crew. Spanner grew up in a small Indo-Canadian conclave just across the border. Unfortunately, his family ran afoul of a local politician looking to acquire their land and willing to use force to do it. After the dust settled, Spanner smuggled his way south to Night City, where he put his technical skills to work as a mercenary. *Appears in Staying Vigilant.* **STAT BLOCK ON PAGE 124.**

**Spooky Sue** (she/her): A stringy-haired, white-gowned street chemist. She's well known for the purity of her street drugs. *Appears in Haven't Got a Stitch to Wear.*

**Sugarplum** (she/her): A member of Lightning Logistics. Sugarplum is a capable Netrunner. Her name refers to her Netrunning icon and not her meat body, which is rather tall. Of the Lightning Logistics lot, she's the most practical and willing to run if things go south. *Appears in Haven't Got a Stitch to Wear.* **STAT BLOCK ON PAGE 89.**



## APPENDIX C: BIOGRAPHIES



**Teresa Senait**



**Trace Santiago**

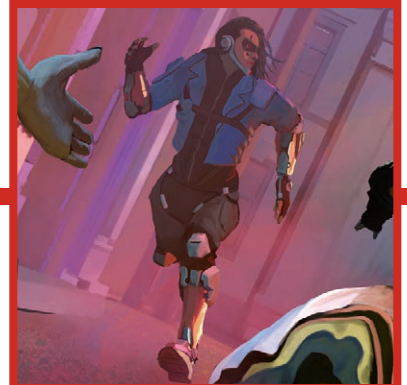

**Two Thee**

**Teresa Senait** (she/her): Co-director, along with her sister Fanta, of sixteen blockbuster Addiswood movies. They co-produce and direct all of their movies with exacting care, preferring to shoot on location with local talent instead of isolating cast and crew on an Ethiopian soundstage. Their movies are incredibly popular around the world but especially well-watched in Africa and the Highrider Confederation. *Appears in A Bucket of Popcorn-Flavored Kibble.*

**Trace Santiago** (he/him): When your dad's the boss of an entire Nomad Nation, it can be hard to make your mark. Trace Santiago is doing just that as a Media. He worked "legit" for a while but went solo after getting passed over for less "ethnic" reporters multiple times. Now he uploads his own reports directly to the Data Pool. Under normal circumstances, he runs with a crew in the Night City area but he's been known to work with or hire other crews when they're too busy to help him out with a story. *Appears in Staying Vigilant.*

**Two Thee** (they/them): A member of the Lost Kids and a resident of Home, a collective of street orphans. Two Thee is an orphan whose parents were murdered by a rival Exec. The de facto lookout, Two Thee says less and listens more. They have long dreadlocks and piercings and prefer to wear athletic gear that allows them to run, dodge, or hide faster than their opponents. They're fond of a word they made up for untrustworthy people: "doombas." *Appears in Bathed in Red. STAT BLOCK ON PAGE 148.*

**Veronica Stiles** (she/her): Before the 4th Corporate War, Veronica Stiles served as the apprentice of Traci Jo Marlowe, Militech freelance wrangler and regular at the Forlorn Hope. When war broke out, Veronica transferred to special forces, earning a fierce reputation in special operations. Following the war, Veronica married and gave birth to a daughter, Jezz. She retired from active operations and returned to life as a wrangler, eventually making her up the ranks and back to Night City where she reconnected with old friends at the Forlorn Hope. Unfortunately, after that, life hit Veronica hard after that. First, she lost her husband to a Militech operation in the American Midwest and had to raise Jezz alone, and then she lost Jezz, too. The higher-ups at Militech didn't believe her theories about a rogue AI and so refused to offer support for Veronica's crusade. So, she's tapped her savings and called in every marker she could to get the resources needed to flatline the Reaper once and for all. *Appears in Reaping the Reaper.*

**Vesper** (they/them): A street tattoo artist and cosmetic ripperdoc who sometimes works out of the RC Night Market. *Appears in Haven't Got a Stitch to Wear.*

**Zero Gees** (she/her): A bartender at Delirium and Magnus Haggard's girlfriend. She's a prototypical punk woman with a buzz cut who prefers white t-shirts, leather jackets, and clip on buttons emblazoned with pithy sayings. Zero Gees has a soft spot for Asher, who calls her mom. She's also the only member of staff who realizes the extent of Haggard's Smash addiction and covers for him when he's drunk himself into a stupor. *Appears in Bathed in Red.*

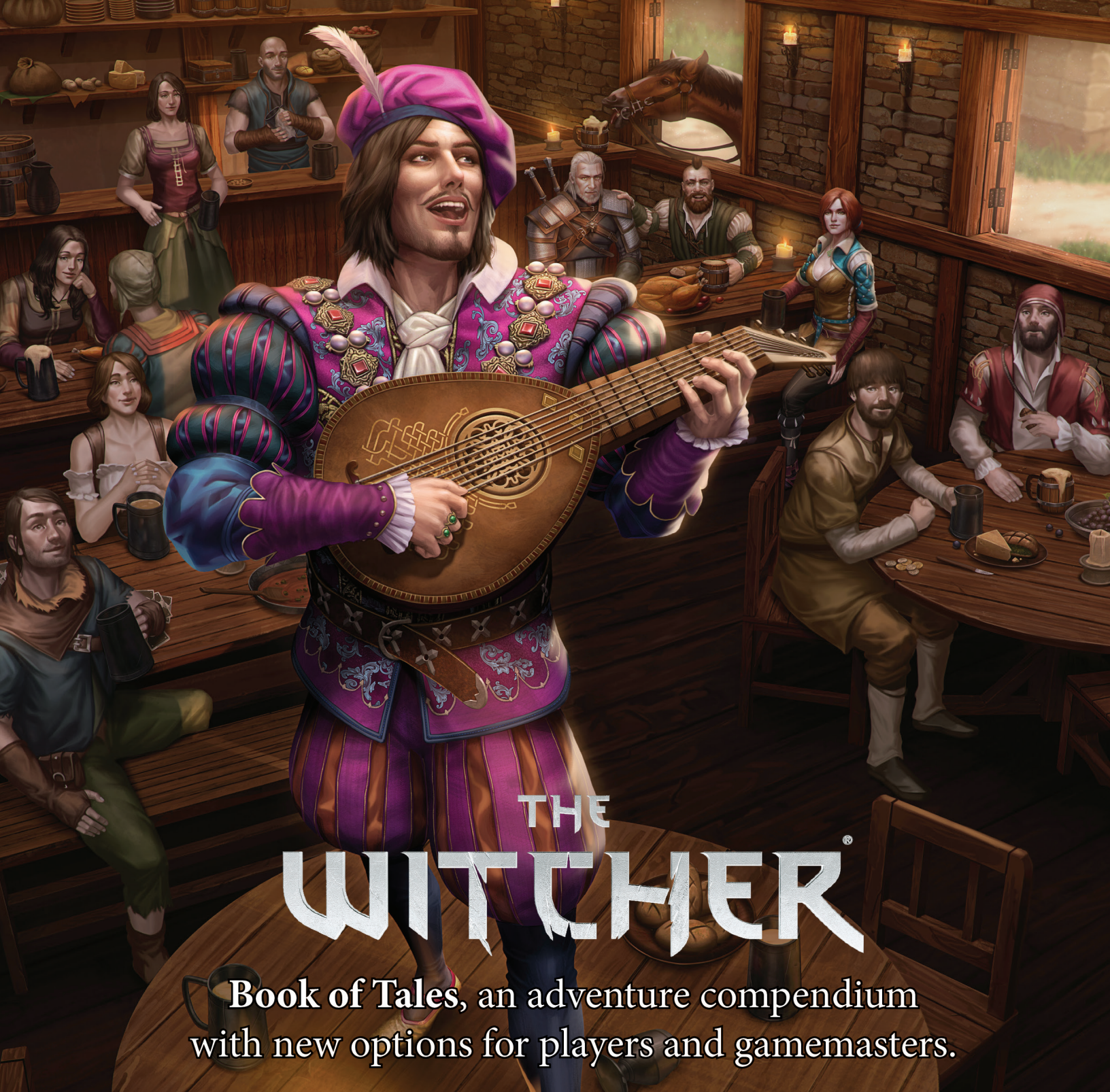

# THE WITCHER<sup>®</sup>

Book of Tales, an adventure compendium with new options for players and gamemasters.



Core Rulebook



GM Screen

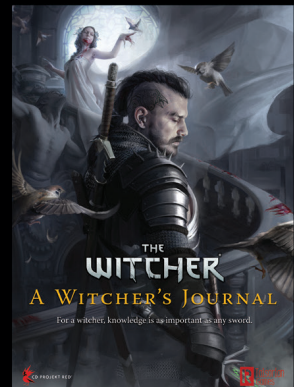

Bestiary

Dark Fantasy in the Bestselling World of the Witcher!



# CYBERPUNK RED COMBAT ZONE™



Take control of your gang and make a name for yourself in the streets of Night City's **Combat Zone™**! Featuring the **[RE]action™** System: easy-to-learn skirmish rules with fast-paced, high-stakes tabletop action.

# CYBERPUNK RED



Bring your adventures to the tabletop with these detailed Cyberpunk RED models. These figures are perfect to use as player characters and NPCs. Each model is made from durable plastic and includes a base.



Visit our site for details!

**MONSTERFIGHTCLUB.COM**

© 2021 R. Talsorian Games, Inc., Cyberpunk is a registered trademark of CD Projekt Red S.A. All rights reserved. [RE]action™ and © Monster Fight Club 2020-2021. All rights reserved.



# MAKE SURE YOUR DECK IS FULLY LOADED



AVAILABLE NOW FROM







# TALES OF THE RED

## STREET STORIES

Night City is a big place, full of wild parties, dead bodies, and neon lights. Beneath the thin layer of advertising and grime, it's got some tales to tell. Stories of vicious gangs, hellbent artificial intelligence, and love. You'll get to meet suave mercenaries and movie stars, and even take a ride in a submarine. You'll fight cyberpsychos, dirty reporters, rival Edgerunners, and a high-flying assault team. The city is voracious. It needs more bodies to chew on, and you'll supply them—one way or another. Within the pages of this book, seemingly simple jobs spiral wildly out of control, and herculean tasks can be solved with a single bullet. It's your city. It hates you. It loves you. And you can't help but feel the same. There's adventure to be had here, and if you know what's good for you, you've gotta experience it, choomba.

*Tales of the RED: Street Stories* is a Mission book for *Cyberpunk RED*, the latest edition of the classic tabletop roleplaying game of the Dark Future. It's a collection of nine never-before-seen full-length missions, ready to play with your Crew.

**R** Talsorian  
Games

**CR3051**

To learn more, please visit  
[rtalsoriangames.com](http://rtalsoriangames.com)

 CD PROJEKT RED®

ISBN 978-1-95-091127-1

US \$ 40.00

54000 >



9 781950 911271